



Exploring the Deep Ocean with NOAA

**Ocean Exploration Education Materials Collection
For Grades 6-12**



**Ocean Exploration
and Research**

National Oceanic and Atmospheric Administration
Office of Ocean Exploration and Research
oceanexplorer.noaa.gov



**NATIONAL
MARINE
SANCTUARY
FOUNDATION**



**Ocean Exploration
and Research**



**NATIONAL
MARINE
SANCTUARY
FOUNDATION**

Revised lessons 2017

Lesson Plan Development: Mel Goodwin, PhD, Marine Biologist and Science Writer, Charleston, SC
Design/Layout: Sandy Goodwin, Coastal Images Graphic Design, Mt Pleasant, SC
Editors: Susan Haynes, Education Program Manager, NOAA Office of Ocean Exploration and Research,
Contractor: Collabralink Technologies Inc.
Debi Blaney, Professional Development Specialist, NOAA Office of Ocean Exploration and Research,
Contractor: Collabralink Technologies Inc.

This collection of materials was produced for NOAA.
If reproducing materials from this collection, please cite NOAA as the source,
and provide the following URL:
oceanexplorer.noaa.gov

For more information, please contact:
David McKinnie, Engagement Division Lead
NOAA Office of Ocean Exploration and Research
oceaneducation@noaa.gov

Front cover images from top left to right: *Iridogorgia* octocoral, hydromedusa, ROV *Deep Discoverer*, brittle stars living in the branches of coral, red crinoid.
Back cover images from top left to right: Bathymetric image of a seamount, red sea toad (3,148m deep), ROV pilots at work, the satellite dome on the NOAA Ship *Okeanos Explorer*, sea anemone, jellyfish.

All images courtesy National Oceanic and Atmospheric Administration (NOAA).



Welcome to Exploring the Deep Ocean with NOAA

Exploring the unknown is fundamental to human nature. “Expeditions”—whether to the next valley or across the seas—have shaped us for millennia. Outer space, often referred to as the final frontier, is not the only frontier left for us to explore; inner space, our Earth’s ocean, is still largely unknown. While we search for water on other planets and moons, much of our own ocean remains to be explored. Satellite radar maps of the surface of Mars and the Moon have a resolution of 100 meters or better. In contrast, satellite maps of the ocean floor have a resolution of about five kilometers, which allows us to see big features, such as major ridges or trenches, but mostly leaves us in the dark about the true nature of the seafloor. What do things look like at the bottom of the ocean? What is happening in the deepest and hardest to reach parts? What types of organisms and creatures live there? How are they different from fauna in shallow waters? Are they related? These questions and many more about the ocean are in and of themselves interesting and important to science. But they are also puzzle pieces in larger questions about ocean processes. How do ocean systems affect global ocean circulation and water chemistry? How does the sea surface interact with the atmosphere? And how do these things impact humans? The answers are critical to understanding the way our ocean works and provide the building blocks on which life on this planet depends.

As NOAA explores the deep sea to fill in more and more pieces of the puzzle and attain a bigger picture, we also want to encourage our youth to become invested in this undertaking. An essential component of OER’s mission is to advance ocean science literacy and the understanding why it is important to explore our little-known ocean world. To help fulfill this mission, we offer the teacher professional development workshop **Exploring the Deep Ocean with NOAA**. It is designed to encourage educators and their students to become engaged with expeditions and discoveries made by the NOAA Ship *Okeanos Explorer* and other ships of exploration and thus inspire the next generation of ocean explorers, scientists, and engineers.

The NOAA Ship *Okeanos Explorer*. Image courtesy NOAA OER.

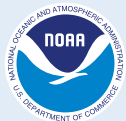

Ocean Exploration and Research

NOAA's Ocean Exploration Mission

The National Oceanic and Atmospheric Administration (NOAA) explores the ocean for national benefit, as America's future depends on understanding the ocean. We explore the ocean because its health and resilience are vital to our economy and to our lives. We depend on the ocean to regulate weather and climate; sustain diversity of life; for maritime shipping and national defense; and for food, energy, medicine, and other essential services to humankind.

NOAA was assigned a leadership role in developing and sustaining a national program of ocean exploration that promotes collaboration with other ocean and undersea research and exploration programs. NOAA's Office of Ocean Exploration and Research (OER) is responsible for coordinating the national ocean exploration program, conducting its own expeditions aboard the NOAA Ship *Okeanos Explorer*, and working with its many partners inside and outside of government to encourage exploration to advance our understanding of the deep ocean.

A NOAA Ship *Okeanos Explorer* mapping track, showing some of the "Mountains in the Deep." The color bar shows the depth of these features in meters. Image courtesy of the NOAA OER, Mountains in the Deep: Exploring the Central Pacific Basin. <http://oceanexplorer.noaa.gov/okeanos/explorations/ex1705/dailyupdates/media/may9.html>

As an educator attending this workshop you play an integral part in fulfilling this mission. The workshop introduces standards-based, hands-on activities and other resources that guide classroom teaching and learning, all of which are assembled for your reference in this binder. For additional information please visit OER's Education website <http://oceanexplorer.noaa.gov/edu/welcome.html> which includes a wide variety of teacher resources, lessons, and hands-on activities relating to topics aligned with our expeditions and supporting the Next Generation Science Standards <https://www.nextgenscience.org/>. The full suite of our ocean exploration *Education Materials Collection*—including Spanish translations—can be found here <http://oceanexplorer.noaa.gov/okeanos/edu/welcome.html>.

Our lives on planet Earth depend on its ocean and our understanding of it. As we explore our ocean world to expand our knowledge of it and its systems, we need to bring future generations of explorers and innovators along for the journey. We hope these materials will help them get started on that journey—it is they who will push the boundaries of human knowledge tomorrow.

David McKinnie, Engagement Division Lead
NOAA Office of Ocean Exploration and Research

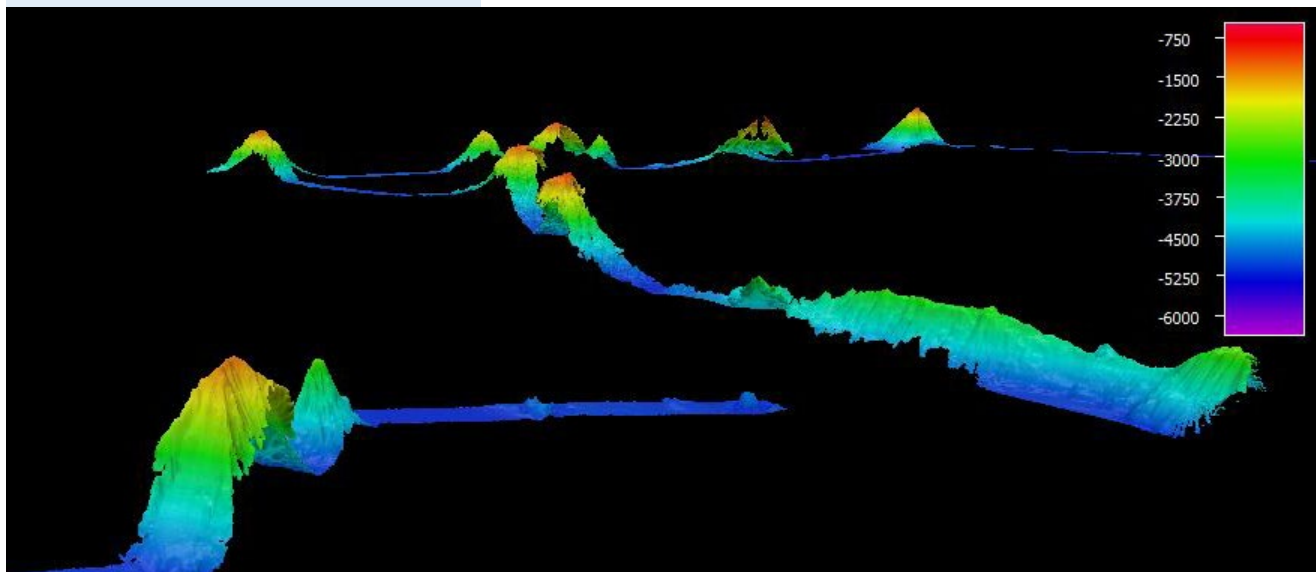

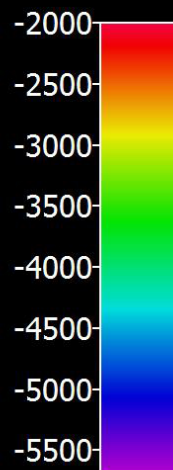
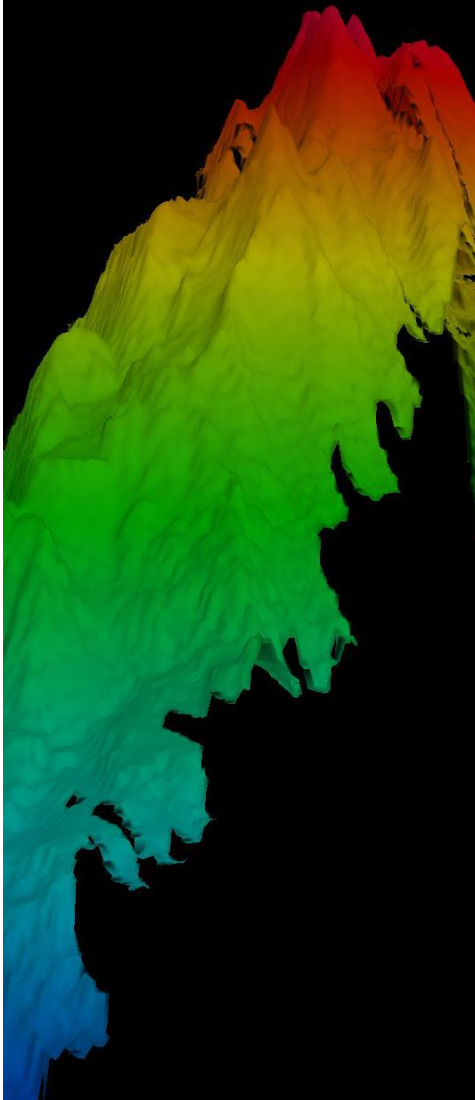

Introduction to Ships of Exploration and Their Strategy for Ocean Exploration

On August 13, 2008, the NOAA Ship *Okeanos Explorer* was commissioned as “America’s Ship for Ocean Exploration;” the only federal U.S. ship whose sole assignment is to systematically explore our largely unknown ocean for the purposes of discovery and the advancement of knowledge. Similar ships are operated by the Schmidt Ocean Institute (R/V *Falkor*) and the Ocean Exploration Trust (E/V *Nautilus*). These three ships of exploration are briefly described below.

While specific activities aboard these ships vary from mission to mission, they all use a similar overall strategy for exploring Earth’s ocean: to develop baseline information about the biological, geological, and water chemistry features of unexplored areas to provide a foundation for future exploration and research. Baseline information includes:

- High resolution maps of the area being explored, as well as areas that the ship crosses while underway from one location to the next (underway reconnaissance);
- Data about water column chemistry and other features; and
- High definition video of biological and geological features in the exploration area (site characterization), as well as additional data about water chemistry, living organisms, and geologic features in this area.

Four key technologies are used to obtain this baseline information:

- Multibeam sonar mapping system and other types of sonar that can detect specific features in the water column and on the seafloor;
- Conductivity, Temperature and Depth profilers (CTDs) and other electronic sensors to measure chemical and physical seawater properties;
- A Remotely Operated Vehicle (ROV) capable of obtaining high-quality imagery and samples in depths as great as 6,000 meters; and

Multibeam image of a seamount rising approximately 3,000 meters (9,840 feet) from the seafloor. Image courtesy of NOAA OER, Mountains in the Deep: Exploring the Central Pacific Basin.

<http://oceanexplorer.noaa.gov/okeanos/explorations/ex1705/dailyupdates/media/may17-1.html>

- Telepresence technologies that allow scientists with many different areas of expertise to observe and interact with exploration activities, though they may be thousands of miles from the ship.

For additional information about these technologies and the types of data they produce, please see the introductory pages for Sonar and Multibeam Mapping, Water Column Investigations, Remotely Operated Vehicles and Autonomous Underwater Vehicles, and Telepresence.



The NOAA Ship *Okeanos Explorer*, America's ship for ocean exploration. Image courtesy NOAA. <http://oceanexplorer.noaa.gov/okeanos/explorations/ex1702/logs/mar1/media/okeanos.html>

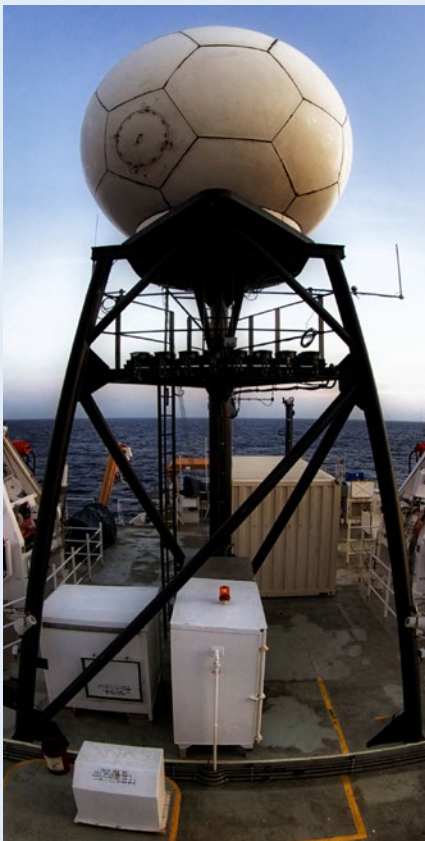

The VSAT (large dome; stands for "Very Small Aperture Terminal") is the critical piece of infrastructure that makes telepresence possible. Image courtesy NOAA OER, Deepwater Wonders of Wake. <http://oceanexplorer.noaa.gov/okeanos/explorations/ex1703/logs/mar16/welcome.html>

NOAA Ship *Okeanos Explorer*

Missions of the *Okeanos Explorer* are focused on initial baseline characterizations of the basic parameters described above. During *Okeanos Explorer* expeditions, data are collected using a variety of advanced technologies. The ship is equipped with four different types of mapping sonars that collect high-resolution data about the seafloor and the water column, as well as a dual-body remotely operated vehicle (ROV) capable of diving to 6,000 meters (19,700 feet) and other instruments to help characterize the deep ocean. Expeditions typically consist of either 24-hour mapping operations or a combination of daytime ROV dives and nighttime mapping operations.

Most of the scientists participating in *Okeanos Explorer* missions remain on shore, thanks to telepresence technology. The ship is equipped with a high-bandwidth satellite communications system capable of transmitting data to scientists and technicians on shore. Using this technology, the ship sends multibeam mapping data; data collected from ship sensors; and real-time, high-definition video feeds from the ROV at high speeds. Scientists can view the live feeds from Exploration Command Centers ashore, or from the comfort of their own desks. These scientists add their expertise to missions no matter where in the world the ships, or the scientists, are located. The same telepresence technology also allows live seafloor video and other data to be broadcast over standard Internet connections, bringing the excitement of

ocean exploration and discoveries into classrooms, newsrooms, and homes—to anyone who has an Internet connection and a passion for learning about the ocean.

Since being commissioned in 2008, NOAA Ship *Okeanos Explorer* has traveled the globe, exploring everywhere from the Indonesian ‘Coral Triangle Region,’ to benthic environments in the Galápagos, canyons and seamounts off the Northeast U.S. coast, and marine protected areas within the Pacific. By collecting baseline information in never-before-explored areas, *Okeanos Explorer* expeditions further our knowledge of many previously unexplored areas while setting the stage for future in-depth exploration activities.

Vital Statistics:

Commissioned: August 13, 2008; Seattle, Washington

Length: 224 feet

Beam: 43 feet

Draft: 15 feet

Displacement: 2,298.3 metric tons

Berthing: 49, including crew and mission support

Operations: Ship crewed by NOAA Commissioned Officer Corps and civilians through NOAA’s Office of Marine and Aviation Operations (OMAO); Mission equipment operated by NOAA’s Office of Ocean Exploration and Research.

For more information, visit <http://oceanexplorer.noaa.gov/okeanos/welcome.html>.



Members of the on-ship science team prepare a sample in the wet lab aboard NOAA Ship *Okeanos Explorer*. Image courtesy of NOAA OER, Mountains in the Deep: Exploring the Central Pacific Basin.

<http://oceanexplorer.noaa.gov/okeanos/explorations/ex1705/dailyupdates/media/apr30-2.html>

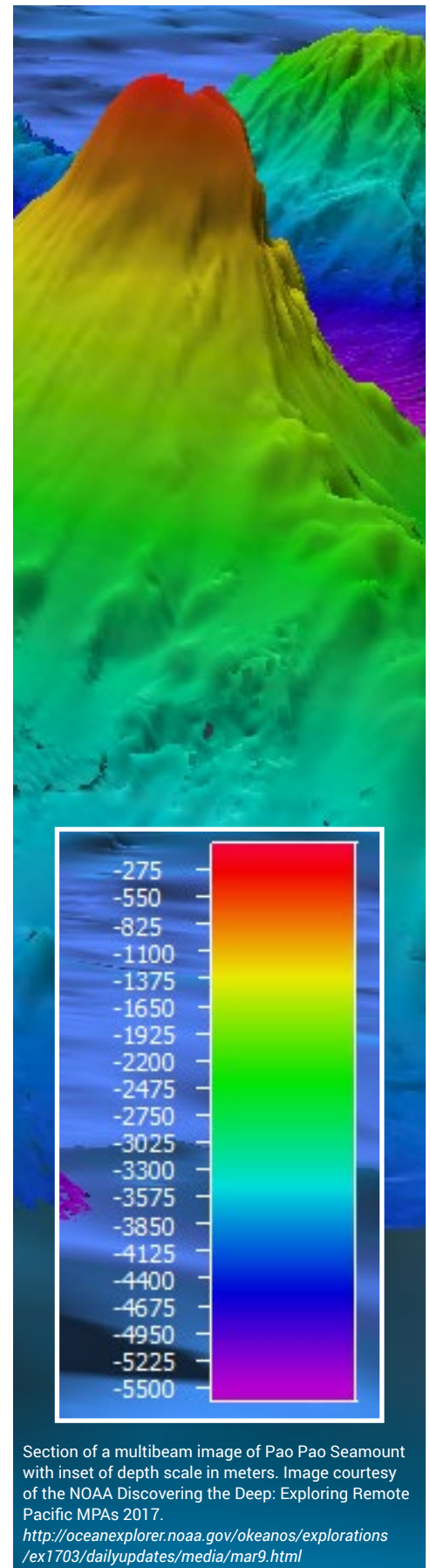

Section of a multibeam image of Pao Pao Seamount with inset of depth scale in meters. Image courtesy of the NOAA Discovering the Deep: Exploring Remote Pacific MPAs 2017.

<http://oceanexplorer.noaa.gov/okeanos/explorations/ex1703/dailyupdates/media/mar9.html>



A CTD (Conductivity, Temperature, Depth). Image courtesy NOAA OER.

<https://oceanexplorer.noaa.gov/explorations/16carolina/logs/photolog/photolog.html#cbpi=.../aug28/media/sentry-lowered.html>

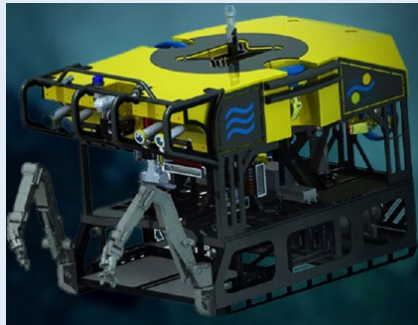

ROV SuBastian.

<https://schmidtocean.org/technology/robotic-platforms/4500-m-remotely-operated-vehicle-rov/>



The sonar gondola beneath *Falkor's* bow. A big challenge for sonar systems on most ships is bubbles. As a ship moves faster, or encounters heavy seas, bubbles formed at the surface wash down the hull, where they can interfere with the sending and receiving of sonar signals. To overcome this issue, *Falkor's* sonar systems are installed on the bottom of a streamlined platform. The sonar systems are embedded into the bottom surface of this gondola, where they are isolated from bubbles, which pass between the hull and the top of the gondola.

<https://schmidtocean.org/technology/sea-floor-mapping/>



The R/V *Falkor*. Image courtesy Schmidt Ocean Institute. <https://schmidtocean.org/collection/falkor/>

R/V *Falkor*

R/V *Falkor* is operated by the Schmidt Ocean Institute, a private non-profit operating foundation established to foster a deeper understanding of our environment by combining advanced science with state-of-the-art technology to achieve lasting results in ocean research, to catalyze sharing of the information, and to communicate this knowledge to audiences around the world.

Technologies aboard R/V *Falkor* include:

- Sonars: EM 302 deep water multi-beam sonar, EM 710 shallow water multi-beam, Simrad EK60 echo sounder, Knudsen CHIRP 3260 sub-bottom profiler, Teledyne Acoustic Doppler Current Profiler;
- CTD sampling rosette and other water column sensors;
- ROV *Seaeye Falcon* with a 300m depth rating, high definition camera, 5-function hydraulic manipulator arm, and hand winch spooled with 600m of protected fiber tether;
- ROV *SuBastian* with a 4500m depth rating, and fitted with a suite of sensors and scientific equipment to support scientific data and sample collection.
- Mammal and Bird Observation from open air Observation Deck above *Falkor's* Bridge; and
- Support for outreach and operations requiring continuous global internet access including VSAT System with dual tracking antennas, video routing from 64 input sources to 64 outputs, internal streaming to Android and iOS devices, modulation over Advanced Television Systems Committee (ATSC) to any TV monitor or projector on *Falkor*, and Conference/Library Room to broadcast presentation and support for video conference calls.

Vital Statistics:

Built: 1981, Lübeck, Germany

Length: 272 feet

Beam: 42 feet

Draft: 19 feet

Tonnage: 2,260 metric tons

Berthing: 41, including crew and mission support

For more information, visit <https://schmidtocean.org/falkor/>



The E/V *Nautilus* explores the ocean. Image courtesy Ocean Exploration Trust.
<http://www.nautiluslive.org/tech>

E/V *Nautilus*

E/V *Nautilus* is operated by the Ocean Exploration Trust (OET), founded in 2008 by Dr. Robert Ballard to explore the ocean. In addition to conducting scientific research, OET offers its expeditions to explorers on shore via live video, audio, and data feeds from the field; and brings educators and students of all ages aboard during E/V *Nautilus* expeditions, offering hands-on experience in ocean exploration, research, and communications.

E/V *Nautilus* is equipped with all of the latest in ocean technology including:

- Multiple sonars and multibeam mapping instruments;
- CTD sampling rosette and other electronic sensors;
- Telepresence capability; and
- ROVs *Hercules* and *Argus*, a tandem system with equipped with high-definition video, sonar, CTD, and a variety of sampling systems.

Vital Statistics:

Built: 1967, Rostock, E. Germany

Length: 211 feet

Beam: 34 feet

Draft: 15 feet

Tonnage: 1249 tons

Berthing: 48, including crew and mission support

For more information, visit <http://www.nautiluslive.org/tech>

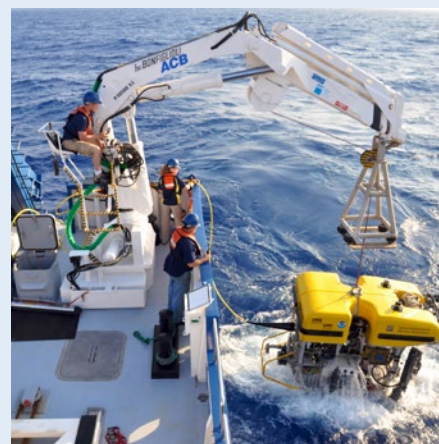

Hercules is recovered by operators on board the E/V *Nautilus* after a dive. Image courtesy of Ocean Exploration Trust.
<http://oceanexplorer.noaa.gov/technology/subs/hercules/hercules-recover.html>



Argus acts as a stabilizing platform for *Hercules*, following the ROV into the water. Image courtesy of Ocean Exploration Trust.
<http://oceanexplorer.noaa.gov/technology/subs/hercules/argus.html>

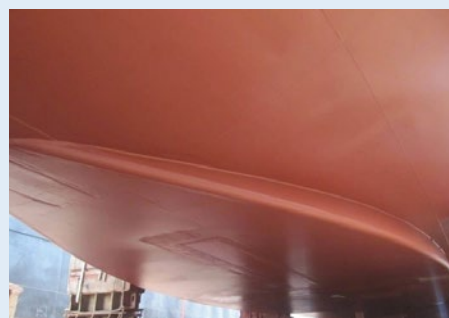

The Kongsberg EM 302 Multibeam Echosounder system, mounted on the ship's hull, can efficiently map the seafloor in waters ranging from 10 meters to 7,000 meters deep, all while the ship cruises at up to 10 knots. The sonar collects bathymetric data, surface sediment characteristics, and water column data. The information it collects helps identify areas or features of interest to plan ROV dives. Image courtesy Ocean Exploration Trust.
<http://www.nautiluslive.org/tech>



Introduction to Telepresence

Ocean environments are complicated combinations of many different geological, chemical, physical, and biological processes. Understanding those processes at a particular location requires many different kinds of experts. The problem is, those experts are often scattered all around the world, and even if it were possible to bring them all together, there isn't enough space aboard ships of exploration to carry every expert that might be needed. The solution to this problem is telepresence; a group of technologies that allows people who are thousands of miles away from an exploring ship to directly participate in exploration activities. In addition to providing access to a broad range of scientific expertise, telepresence also allows the public to observe and follow expeditions in real time.

The foundation for telepresence is radio technology, and while students may consider radio to be old and pretty much out-of-date it is the basis for cell phones, wireless Internet, satellite communications, garage door openers, remote controls, and many other things that we use every day, and that we think of as "modern." Aboard the NOAA Ship *Okeanos Explorer*, the most prominent piece of radio equipment is the large dome (radome) that houses the ship's 2.4-meter Very Small Aperture Terminal (VSAT) dish antenna, owned and operated by NOAA's partners at the Global Foundation for Ocean Exploration.

The VSAT antenna is the critical link between the *Okeanos Explorer* and the satellites that relay information to shore-based Exploration Command Centers (ECCs) where scientists are able to be directly involved with expedition operations. These satellites are 22,753.2 statute miles ("normal" miles, not nautical miles) above Earth's surface. At this altitude, the satellites are geosynchronous, which means their rotational speed matches the speed of Earth's rotation so they appear to remain in a fixed position when viewed from Earth's surface. On the ship, computers, motors, and other hardware make constant adjustments that compensate for the ship's heave, roll

The VSAT (large dome; stands for "Very Small Aperture Terminal") is the critical piece of infrastructure that makes telepresence possible. Image courtesy NOAA OER, Deepwater Wonders of Wake. <http://oceanexplorer.noaa.gov/okeanos/explorations/ex1703/logs/mar16/welcome.html>

Exploring the Deep Ocean with NOAA



Telepresence technology allows anyone with Internet to follow an exploration...even over breakfast while on vacation. Image courtesy of NOAA OER, Gulf of Mexico 2014 Expedition.
http://oceanexplorer.noaa.gov/oceanos/explorations/ex1402/logs/apr18_b/media/tarttboys.html



Scientist Scott France participates in the dives from his home office via telepresence. Image courtesy of NOAA OER, 2016 Deepwater Exploration of the Marianas.
<http://oceanexplorer.noaa.gov/oceanos/explorations/ex1605/logs/jun28/media/1605scott-france.html>

Telepresence explained graphically. Image courtesy NOAA OER.

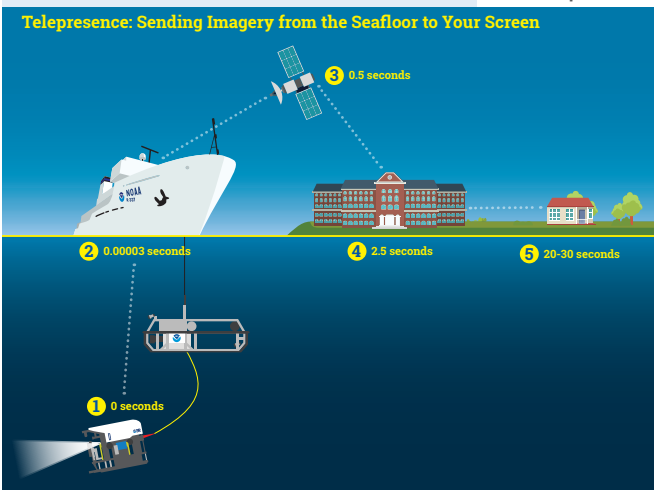

The NOAA Ship *Okeanos Explorer*, America's ship for ocean exploration. Image courtesy NOAA.
<http://oceanexplorer.noaa.gov/oceanos/explorations/ex1702/logs/mar1/media/oceanos.html>

and pitch to keep the antenna pointed toward the appropriate communications satellite. Radio transmitters and receivers connected to the VSAT antenna operate on "C-band" frequencies, which are in the microwave region of the electromagnetic spectrum.

To bring experts in many remote locations onto the exploration team, the telepresence system must provide two-way communication for several types of information. Live video is perhaps most important, and is provided in three high-definition streams. The first is from the camera of the the remotely operated vehicle (ROV) *Deep Discoverer*; the second is from the camera sled *Serios* (for additional information about the two-body ROV system, please see the *Introduction to Underwater Vehicles* <http://oceanexplorer.noaa.gov/oceanos/edu/collection/media/hdwe-URintro.pdf>); and the third video stream can carry video from the ROV's navigation computers display, the ROV's scanning sonar, information from the ROV's Conductivity, Temperature and Depth profiler (CTD), or one of the additional camera on the ROVs. These video streams operate in near-real time, but there is always a time lapse before a viewer on shore can see what happened on the bottom of the ocean (this lapse is called latency). With a specialized internet connection the latency is only about 2.5

seconds. With other types of connection latency can range from 5 to 30 seconds. The live video streams only move information one way. To move information from shore-based scientists back to the ship in real time, telepresence relies on a teleconference call system and an online chatroom. Like most chatrooms, anyone logged into the system can add their comments to the conversation.

Two-way telepresence communications also allows other kinds of participation. To annotate video recorded during ROV dives, for example, NOAA works with Ocean Network Canada to use their Oceans 2.0 software suite to allow researchers anywhere in

the world to make notations and observations that are publicly available. These annotations are a very important part of the process of working up video data for further analysis, as well as for helping manage and search all the data that are collected. Another example of participation via two-way telepresence communication is “telepresence mapping” in which key members of the expedition team work from the University of New Hampshire’s ECC to run mapping operations on the ship, as well as do data processing tasks and even assist with troubleshooting sonar systems.

Telepresence streamlines other data management tasks with a custom suite of software and standard operating procedures that automatically collect raw and some processed data from all the different acquisition computers, and then move that data to a central server called the data warehouse. Then the system automatically moves all the data over the satellite connection to shore as bandwidth is available. Once the data are in the data warehouse, any member of the science team can access the data on an FTP site.



An Exploration Command Center (ECC) at Underwater World Guam. Image courtesy of NOAA OER, 2016 Deepwater Exploration of the Marianas. <http://oceanexplorer.noaa.gov/oceanos/explorations/ex1605/logs/apr20/media/uww1.html>

(Left) An RTS unit in *Okeanos Explorer*'s control room. RTS units use an IP-enabled intercom system, leveraging the *Okeanos Explorer*'s Internet connectivity to connect all of the ship-based and shore-based intercom units into a single system. Image courtesy of NOAA OER, INDEX-SATAL 2010. http://oceanexplorer.noaa.gov/oceanos/explorations/10index/logs/july09/media/rts_unit.html



(Below) Prior to a cruise, NOAA OER coordinators conduct training webinars to teach scientists and students how to use Internet-based collaboration tools to participate in the expedition from shore. Here, a group tunes into the live feeds from the Inouye Regional Center (IRC) ECC in Hawaii. Image courtesy of NOAA OER, 2016 Deepwater Exploration of the Marianas. <http://oceanexplorer.noaa.gov/oceanos/explorations/ex1605/logs/apr20/media/irc.html>



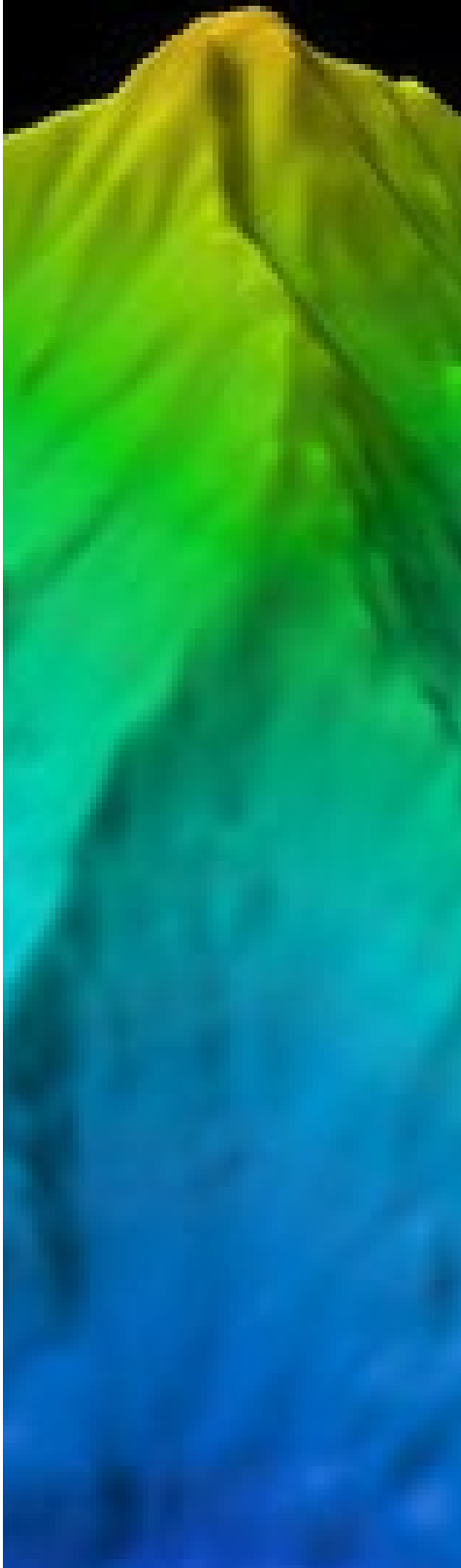

Introduction to Sonar and Multibeam Mapping

SOund Navigation and Ranging (sonar) systems consist of a transmitter that sends pulses of sound energy through the water and a receiver that detects return signals (echoes) that are reflected back from the seafloor or other objects, including living organisms. In use, an acoustic signal or pulse of sound (often called a ping) is transmitted into the water by a sort of underwater speaker known as a transducer. The transducer may be mounted in a variety of ways including on the hull of a ship, on a pole, on underwater vehicles, or towed in a container called a towfish. If the seafloor or another object is in the path of the sound pulse, the sound bounces off the object and returns an echo to the sonar transducer. The time elapsed between the emission of the sound pulse and the reception of the echo is used to calculate the distance of the object. Some sonar systems also measure the strength of the echo, and this information can be used to make inferences about some of the reflecting object's characteristics. Hard objects, for example, produce stronger echoes than softer objects because softer objects absorb some of the sound energy instead of reflecting the energy. Modern ocean exploration vessels use several types of sonar.

Multibeam sonar is one of the most powerful tools available for modern deep-sea exploration. A multibeam system uses multiple transducers pointing at different angles on either side of a ship to create a swath of signals. The NOAA Ship *Okeanos Explorer* is equipped with a Kongsberg EM 302 multibeam system that uses separate transducers for transmitting and receiving acoustic signals. These transducers are mounted to the ship's hull in a T-shaped arrangement known as a Mills Cross configuration. In this arrangement, transmitting transducers are arranged so they are parallel to the ship's keel, and receiving transducers are arranged to be perpendicular to the keel. This system produces a swath of sound pulses in the 30 kHz frequency range, and can generate up to 864 soundings per ping. The maximum width of the swath is approximately eight kilometers. The EM 302 is designed to produce maps in depths ranging from 10 to 7,000

This ~4,200-meter (~13,800-foot) high seamount called "Kahalewai" was almost 1,000 meters taller than previously thought. Image courtesy of NOAA OER, Mountains in the Deep: Exploring the Central Pacific Basin.

<http://oceanexplorer.noaa.gov/okeanos/explorations/ex1705/dailyupdates/media/may3-2.html>

Exploring the Deep Ocean with NOAA

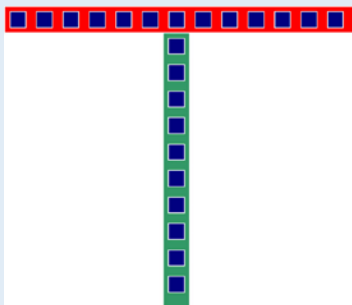

Mills Cross configuration, separate transmit and receive arrays. Image courtesy of NOAA. <http://oceanexplorer.noaa.gov/oceanos/explorations/ex1503/logs/jun6/media/mills-cross.html>



None of the sonars on the ship are standalone units, they all have transducers mounted on the hull of the ship and then a top-side unit located within the ship. The top-side unit does some signal processing on the acoustic returns. The top-side units are connected to computers that run data acquisition software. The image above is the top-side unit of the Knudsen Chirp, courtesy of Knudsen Engineering Limited. <http://oceanexplorer.noaa.gov/oceanos/explorations/ex1503/logs/jun6/media/knudsen-chirp.html>

Multibeam sonar bathymetry of Mona Canyon, off the northwest coast of Puerto Rico, showing large landslides that might be related to the 1918 magnitude-7.3 earthquake. Image courtesy of NOAA OER, Océano Profundo 2015: Exploring Puerto Rico's Seamounts, Trenches, and Troughs. <http://oceanexplorer.noaa.gov/oceanos/explorations/ex1502/logs/apr27/media/mona.html>

meters, but the system aboard the *Okeanos Explorer* has been able to detect the seafloor at depths exceeding 8,000 m.

The Knudsen Chirp 3260 sub-bottom profiler sonar is used to collect shallow seismic reflection profiles, which provide details about sediment layers below the seafloor. When the acoustic signal (ping) reaches the seafloor, some of the acoustic energy will penetrate the seafloor surface. The ping will be reflected when it encounters a boundary between two layers of materials that have different densities, and the reflected energy can be used to provide information about the layers (technically, the sub-bottom profiler detects changes in acoustic impedance, but this can be generally thought of as changes in density). The Knudsen Chirp 3260 system operates at a frequency of 3.5 kHz, and can survey the seafloor at water depths up to 10,000 meters.

Split beam echosounders (such as the Simrad EK60 sonars on the hull of the *Okeanos Explorer*) are able to detect various-sized objects and are widely used for fishery research. The EK60 uses a single split beam transducer that emits pings at a single frequency. Transducers are available for frequencies ranging from 18 to 710 kHz. The acoustic properties at different frequencies vary among pelagic species, so the ability to compare return signals at different frequencies provides a way to identify species detected by the sonar system. At present, the *Okeanos Explorer* uses five EK60 echosounders operating at 18, 38, 70, 120, and 200 kHz to detect acoustic signals from objects that include fish, plankton, seeps, and hydrothermal vents. Because these echosounders can detect bubbles in the water column, ships of exploration have been able to discover hundreds of previously unknown methane seeps off the Atlantic and Pacific U.S. coasts (please see the *What's the Big Deal?* http://oceanexplorer.noaa.gov/oceanos/edu/collection/media/wdwe_bigdeal.pdf lesson for additional details).

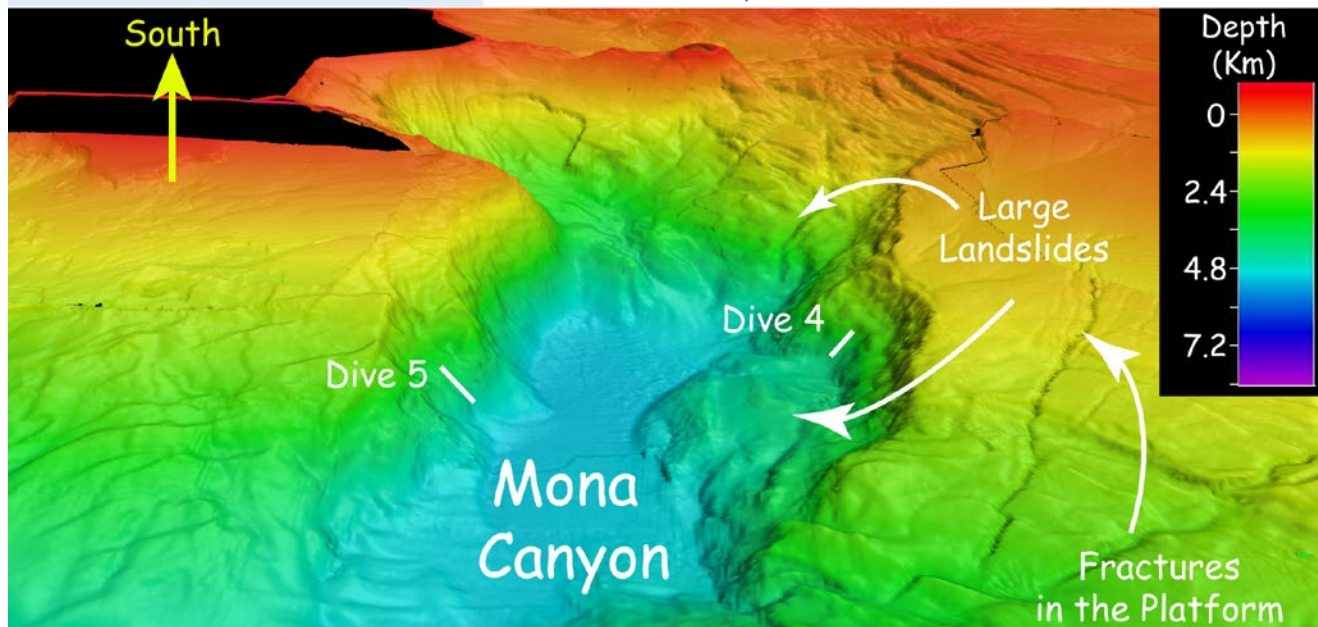

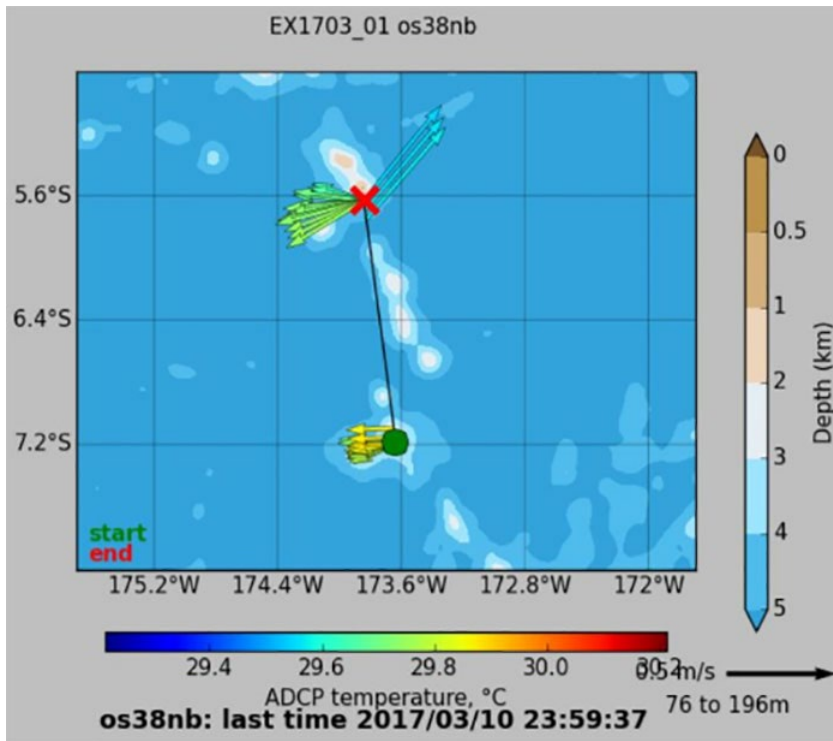

Example of an ADCP vector plot. The red "X" is the location of the ship. The many arrows coming from the X show the magnitude and direction of currents at a variety of depths beneath the ship. Image courtesy of NOAA OER, *Discovering the Deep: Exploring Remote Pacific MPAs*.

<http://oceanexplorer.noaa.gov/oceanos/explorations/ex1703/logs/mar11/media/acdp.html>

Acoustic Doppler Current Profilers (ADCP) are another type of sonar system that measure the speed and direction of ocean currents using the principle of "Doppler shift". If you have ever heard a train whistle you are probably familiar with the Doppler effect. As the train travels towards you, the whistle's pitch is higher. When it passes you and is moving away, the pitch is lower. The change in pitch is proportional to the speed of the train. The ADCP emits a series of high frequency sound pulses that scatter off of moving particles in the water. Depending on whether the particles are moving toward or away from the sound source, the pitch of the return signal is either higher or lower, and the frequency shift is proportional to the speed of the water. Two ADCPs are presently aboard NOAA Ship *Okeanos Explorer*. The Workhorse Mariner ADCP operates at 300 kHz, and is capable of collecting current profiles up to about 100 m below the sea surface. The Ocean Surveyor ADCP operates at 38 kHz and is capable of collecting current profiles up to 1000 to about 1300 m below the sea surface.

The NOAA Office of Ocean Exploration and Research pursues every opportunity to map, sample, explore, and survey at planned destinations as well as during transits; "Always Exploring" is a guiding principle. Mapping data is collected at all times when the ship is transiting and underway. This image shows the multibeam bathymetry data acquired during the ship's transit west from Oahu to the Johnston Atoll Unit. Image courtesy of NOAA OER.

<http://oceanexplorer.noaa.gov/oceanos/explorations/ex1706/dailyupdates/media/july11.html>



Introduction to Water Column Investigations

The “water column” extends from the ocean surface to the seafloor. The water column usually refers to the volume of water underlying a specific area of Earth’s ocean. In the broadest sense, the water column may mean the entire volume of water in the ocean, from coast to coast. Because the ocean covers 71% of Earth’s surface with an average depth of nearly 4 km, the water column is the largest habitat for life on this planet. A variety of technologies are used to explore the water column, including:

Nets and other devices to capture living organisms – Animals in the water column were first studied using trawl nets, which is still a primary technology for obtaining specimens of animals large enough to be captured in the net. Plankton nets have a much smaller mesh than trawl nets, and are used to capture phytoplankton (microscopic plants) and small zooplankton (including larvae of many species as well as animals that are very small for their entire lives). Other capture devices include pumps combined with mesh filters, and various types of sampling bottles designed to collect water samples from specific depths. The latter method has been widely used to collect phytoplankton.

Sonar – SOund NAVigation and Ranging (sonar) systems consist of transmitters that send pulses of sound energy through the water and receivers that detect return signals (echoes) that are reflected back from the seafloor or other objects. Modern ocean exploration vessels use several types of sonar for mapping, detecting smaller objects (fish-size to bubble-size) objects in the water column, measuring the speed and direction of ocean currents, and to obtain details about sediment layers below the seafloor.

For additional details, please see the *Introduction to Sonar and Multibeam Mapping* <http://oceanexplorer.noaa.gov/oceanos/edu/collection/media/hdwe-MMBkgnd.pdf>.

Water samples are collected from the Niskin bottles on the CTD. All 20 Niskin bottles take water samples from various depths, starting near the seafloor and ending close to the surface. Photo courtesy of Caitlin Bailey, GFOE, *The Hidden Ocean 2016: Chukchi Borderlands*. <http://oceanexplorer.noaa.gov/explorations/16arctic/logs/july24/media/shipton.html>

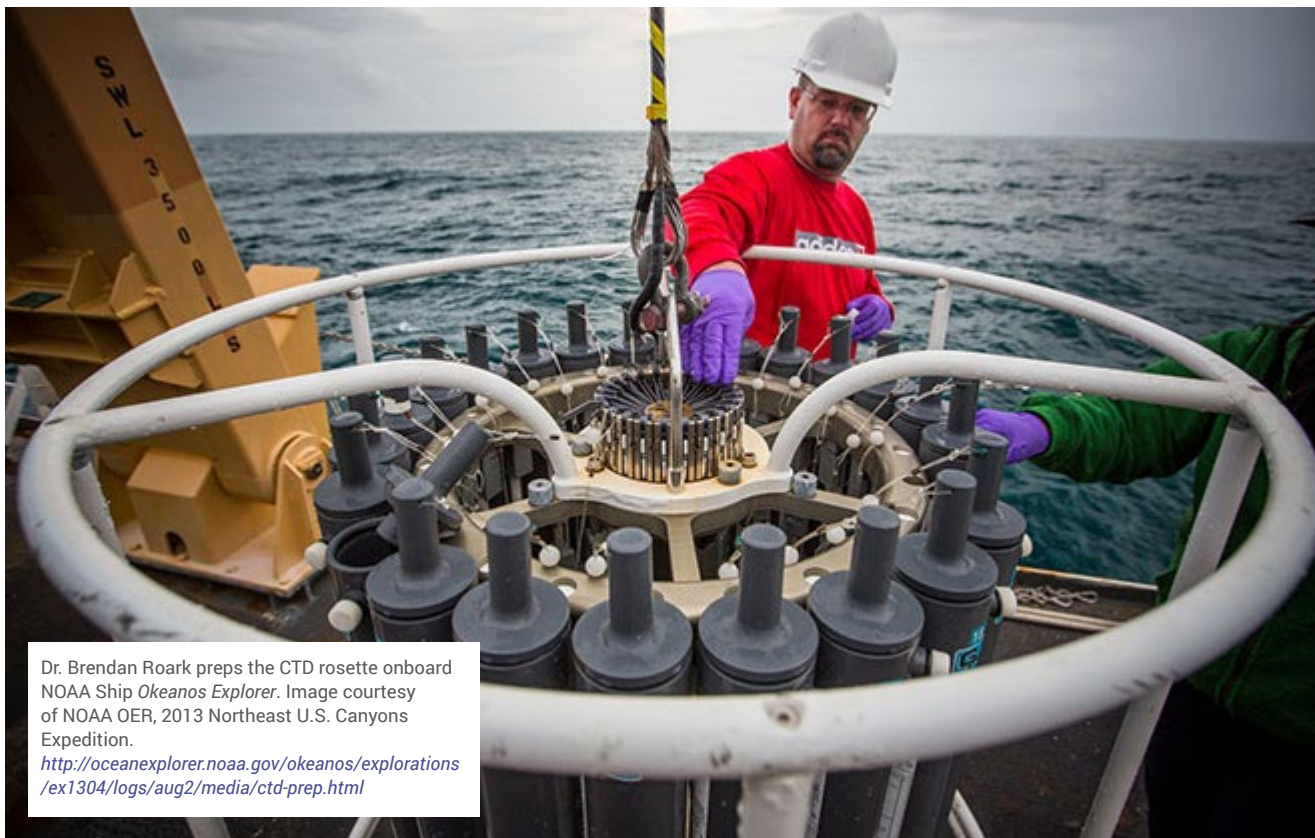

Dr. Brendan Roark preps the CTD rosette onboard NOAA Ship *Okeanos Explorer*. Image courtesy of NOAA OER, 2013 Northeast U.S. Canyons Expedition.
<http://oceanexplorer.noaa.gov/okeanos/explorations/ex1304/logs/aug2/media/ctd-prep.html>

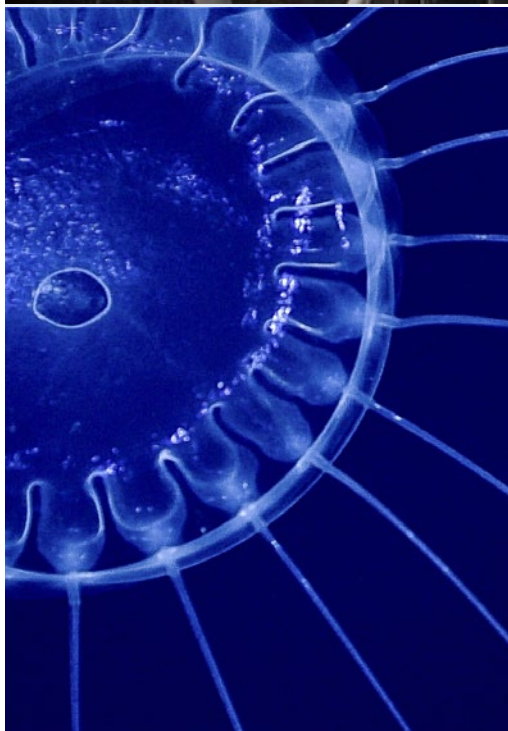

Solmissus jellyfish observed during midwater transects during Dive 17 of the Deep-Sea Symphony. Exploring the Musicians Seamounts expedition. Image courtesy of NOAA OER, Deep-Sea Symphony. Exploring the Musicians Seamounts.
<http://oceanexplorer.noaa.gov/okeanos/explorations/ex1708/dailyupdates/media/sept23-2.html>

CTDs and Electronic Sensors -- Just as bathymetry of the ocean floor is essential knowledge for ocean explorers, it is equally important to know the physical and chemical properties of the water column. Scientists use the term “water mass” to describe a parcel of water that has similar properties. By measuring certain physical and chemical properties of seawater, oceanographers are able to identify and track water masses to understand how water circulates around the ocean. Temperature and salinity are the two main properties used to identify water masses, and are probably the most common measurements made in the ocean.

A CTD is a package of electronic devices that measure conductivity, temperature, and depth. Devices to measure other parameters also may be included, but the package is still called a CTD. Conductivity is a measure of how well a solution conducts electricity and is directly related to salinity, which is the concentration of salt and other inorganic compounds in seawater. Salinity is one of the most basic measurements used by ocean scientists. When combined with temperature data, salinity measurements can be used to determine seawater density, which is a primary driving force for major ocean currents. CTDs are often attached to a much larger metal frame called a rosette, which may hold water sampling bottles that are used to collect water at different depths. Additional sensors may be included on a CTD, such as dissolved oxygen, fluorescence (used to measure chlorophyll concentration and color dissolved organic matter including oil), pH, optical backscatter (a measure

of suspended particles), and many other chemical compounds. A traditional CTD-rosette system is typically lowered to depth just once at each station while the ship is stationary. CTD sensors and sonars can also be included on other types of platforms such as underwater vehicles and moorings.

Some localized water column areas are of particular interest. For example, fronts are areas where two different water masses come together. Fronts often coincide with large aggregations of animals from small zooplankton up to large fishes and marine mammals. Another example is water in the vicinity of hydrothermal vents (see <https://www.pmel.noaa.gov/eoi/PlumeStudies/plumes-what-is.html> for additional details). One way to detect hydrothermal vents is the “tow-yo” technique in which a CTD package is lowered to near the bottom, then the package is moved up and down from just above the seafloor to a few hundred meters above the ocean bottom as the ship slowly moves over the area being studied. Sudden changes in temperature or other chemical properties can signal the presence of hydrothermal vents (see <https://www.pmel.noaa.gov/eoi/PlumeStudies/WhatsACTD/tow-yo-method.html> for additional details). In the past, NOAA Ship *Okeanos Explorer* has conducted tow-yo operations to detect anomalies in the water column, particularly in areas where scientists think there may be hydrothermal vents.

Underwater Vehicles – Since the 1930’s manned submersibles have been used to observe animals in the water column, though most submersible developments have focused on the seafloor. Today, remotely operated vehicles (ROVs) have almost entirely replaced manned submersibles as the primary means to directly access the deep sea. Advances in ROV technology have improved our understanding of water column animals by facilitating observations of animal behavior, enabling collections of live specimens in pristine condition, conducting manipulative experimentation, and assessing community composition. Technologies exist to collect delicate animals like jellyfish intact and conduct experiments on them underwater. Autonomous underwater vehicles (AUVs) are another type of unmanned underwater vehicle. Unlike ROVs, which are attached to a support vessel by a cable or tether, AUVs can operate without any direct connection to a ship. This independence means that AUVs can be programmed to accurately survey an underwater area for many hours without continuous human support. Underwater vehicles can be equipped with video photography equipment, sonars, CTDs, and a variety of other instruments. Please see the *Introduction to Remotely Operated Vehicles and Autonomous Underwater Vehicles* <http://oceanexplorer.noaa.gov/okeanos/edu/collection/media/hdwe-URintro.pdf> for additional details.



The forward-facing high-definition camera is the most commonly seen view from ROV *Seirios*. Image courtesy of NOAA OER, Deep-Sea Symphony: Exploring the Musicians Seamounts. <http://oceanexplorer.noaa.gov/okeanos/explorations/ex1708/logs/sept26/media/camera.html>

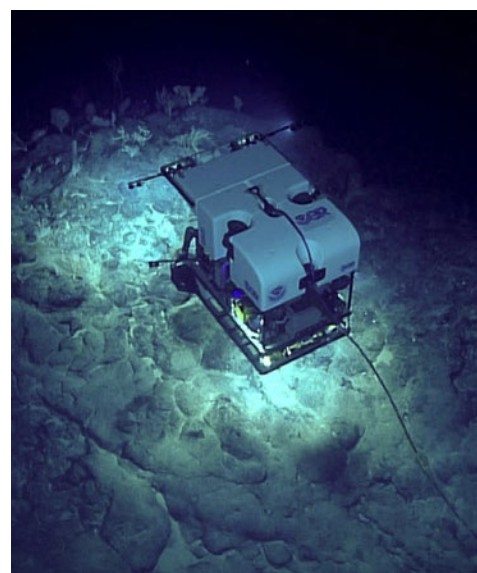

Much like its namesake, ROV *Seirios* acts as a brilliant source of light in the “night sky” of the ocean, providing illumination and a wide-angle view from above for its counterpart ROV *Deep Discoverer*. Image courtesy of NOAA OER Deep-Sea Symphony: Exploring the Musicians Seamounts. <http://oceanexplorer.noaa.gov/okeanos/explorations/ex1708/logs/sept26/media/dd2.html>



Introduction to Remotely Operated Vehicles and Autonomous Underwater Vehicles

Since the 1930's manned submersibles have been used to observe animals in the water column, though most submersible developments have focused on the seafloor. The opportunity to have a first hand look into the deep ocean holds a powerful attraction for many ocean explorers; but the risk to human life and high cost have placed serious limitations on this type of ocean exploration. Today, thanks to rapid advances in electronics and other technologies, unmanned vehicles have almost entirely replaced manned submersibles as the primary means to directly access the deep sea. Two types of unmanned vehicles are regularly used in ocean exploration missions.

Remotely operated vehicles (ROVs) — These are unoccupied robots usually linked to an operator aboard a surface ship by a group of cables. Most ROVs are equipped with one or more video cameras and lights, and may also carry other equipment such as a manipulator or cutting arm, water samplers, equipment for collecting biological and/or geological samples, and measuring instruments to expand the vehicle's capabilities for gathering data about the deep-ocean environment. ROV developments have improved the understanding of water column animals by facilitating observations of animal behavior, enabling collections of live specimens in pristine condition, conducting manipulative experimentation, and assessing community composition.

Specific ROV systems vary among ships of exploration. Aboard R/V *Falkor*, ROV operations use the *Seaeye Falcon* with a 300 m depth rating, high definition camera and 5-function hydraulic manipulator arm. *Falcon's* compact size (weight = 60 kg out of the water; external dimensions = 1 m x 0.5 m x 0.6 m) makes it ideal for shallow-water surveys, and has been used extensively for remote coral reef survey work. The *Falkor* also operates *SuBastian*, an ROV rated to 4500 meters and fitted with a suite of sensors and scientific equipment to support scientific data and sample collection, as well as interactive research, experimentation, and technology development.

Sometimes form wins—*Deep Discoverer (D2)* is an elegant and powerful 9,000 pounds, designed to bring optimal imagery topside, where it is then shipped to shore in real time. Image courtesy of NOAA OER, Gulf of Mexico 2014 Expedition.

<http://oceanexplorer.noaa.gov/oceanos/explorations/ex1402/logs/apr15/media/drfront.html>

Exploring the Deep Ocean with NOAA

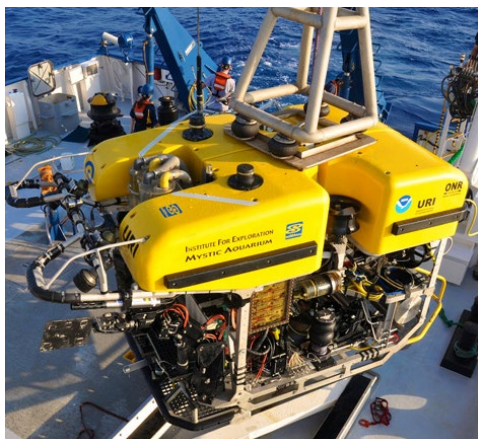

Hercules is one of the very few Remotely Operated Vehicles (ROV) specifically designed to be used as a scientific tool. Built for the Institute For Exploration (IFE), *Hercules* is equipped with special features that allow it to perform intricate tasks while descending to depths of 4,000 meters (2.5 miles).

<http://oceanexplorer.noaa.gov/technology/subs/hercules/hercules.html>

Argus (right) acts as a stabilizing platform for *Hercules*, following the ROV into the water. Image courtesy of The Ocean Exploration Trust.

<http://oceanexplorer.noaa.gov/technology/subs/hercules/argus.html>

The ROV Went Dark - What Happened?



On Tuesday, July 18, 2017, at 1:13 PM, while diving on an unnamed seamount near Johnston Atoll approximately 800 miles west of Hawaii, remotely operated vehicle (ROV) *Deep Discoverer* encountered a problem. The type of problem which causes the ROV Navigator to report to the Bridge that, "The vehicle has lost power and communications—bail out, bearing 225, speed 0.5 knots." The type of problem which forces a "dead vehicle recovery," ends a dive early, and cancels dives for the next two days. Go to the link below to find out what happened and how the problem was solved.

<http://oceanexplorer.noaa.gov/oceanos/explorations/ex1706/logs/july28/welcome.html>

The E/V *Nautilus* has a two-part ROV system:

- ROV *Hercules*, equipped with six thrusters that allow pilots to maneuver it in any direction, plus two manipulator arms for collecting samples and recovering artifacts, and a high-definition video camera connected via a fiber-optic cable to the control van on *Nautilus*. *Hercules* is capable of operating down to 4,000 meters, and also carries profiling sonars, a Sea-Bird FastCAT 49 CTD, a suction sampling system, and a variety of containers for biological and geologic samples.
- ROV *Argus* is a stainless steel towed-style vehicle that dampens the roll of the ship so *Hercules* can remain steady through sensitive operations. *Argus* also provides additional light and serves as an "eye in the sky" during operations. When operating alone, it can dive deeper than *Hercules* - down to 6,000 meters. In addition to high definition video cameras, *Argus* also carries profiling sonar, a sub-bottom profiler, and sidescan sonar.



The NOAA Ship *Okeanos Explorer* also uses a two-part ROV system consisting of ROV *Deep Discoverer* (also known simply as "D2") operated in tandem with its sister vehicle, *Seirios*. Technically classified as a 'camera sled', *Seirios* is directly tethered to the *Okeanos Explorer* by a six mile-long armored cable containing power conductors and optical fibers for exchanging data and control signals, and provides ROV pilots with a birds-eye view of D2 as the pair moves over a survey area. Both vehicles are equipped with high-definition cameras and powerful lighting equipment. D2's primary camera is capable of zooming in on a three-inch long organism from 10 feet away, while *Seirios* currently has a high-definition camera, a wide fisheye 'bubble' camera, and several standard-definition cameras that improve pilots' "situational awareness" (knowledge of surrounding



environmental conditions). *D2* weighs in at 9,200 lb (4,173 kg), has an overall length of 3.2 m, and stands 2.6 m tall. It has a total sensor payload of over 400 lb (181 kg), a Predator II robotic arm, a hydraulically actuated sensor platform, full color sector scan sonar (a type of sonar that provides a panoramic display of objects around and below a vessel by sending sound pulses in an arc or full circle around a vessel and detecting echoes returned when some of the sound energy bounces off objects in the path of the pulses), and a fully integrated inertial navigation system (which uses gyroscopes and accelerometers to calculate a vessel's position, rather than external references such as satellites used in global positioning systems).

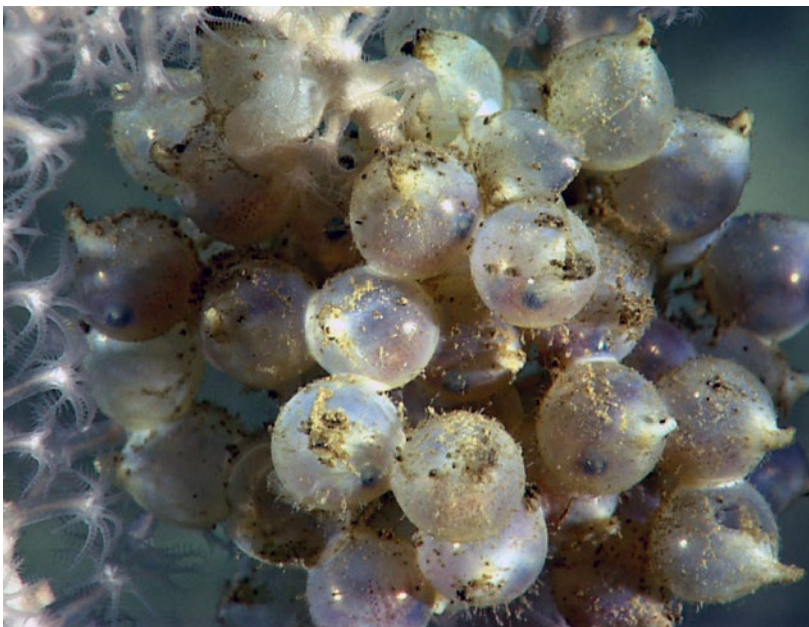

D2's high-definition cameras are providing scientists and public audiences around the world with close-up glimpses of things we might otherwise never see. Here, *D2* captures an image of tiny bobtail squid eggs, getting so close that you can actually see the eyes of the squid. Image courtesy of the NOAA OER, *Okeanos Explorer* Gulf of Mexico 2014 Expedition. <http://oceanexplorer.noaa.gov/technology/subs/deep-discoverer/media/squid-eggs.html>

Given all of the ROV's high-tech bells and whistles, it takes a highly skilled team to keep *D2* operating smoothly. Image courtesy of NOAA OER. <http://oceanexplorer.noaa.gov/technology/subs/deep-discoverer/media/d2-team.html>



The forward-facing high-definition camera (pictured above) is the most commonly seen view from ROV *Seirios*. Image courtesy of NOAA OER, Deep-Sea Symphony: Exploring the Musicians Seamounts. <http://oceanexplorer.noaa.gov/okeanos/explorations/ex1708/logs/sept26/media/camera.html>



Remotely operated vehicle *Deep Discoverer*'s manipulator arm, labeled. Image courtesy of Art Howard, GFOE, edited by Jeffery Laning, GFOE. <http://oceanexplorer.noaa.gov/okeanos/explorations/ex1702/logs/feb28/media/d2arm.html>

Exploring the Deep Ocean with NOAA



The AUV *Sentry* being lowered into the water. Image courtesy of NOAA OER Exploring Carolina Canyons expedition.
<http://oceanexplorer.noaa.gov/explorations/16carolina/logs/aug28/media/sentry-lowered.html>



The autonomous benthic explorer (ABE) a free-swimming robot, was used on multiple expeditions to find new hydrothermal vents in the deep ocean all over the world, from New Zealand to South Africa and Brazil to Ecuador. Photo courtesy of Christopher German.
<http://oceanexplorer.noaa.gov/explorations/10chile/background/exploration/media/exploration1.html>

NOTE: ABE was lost at sea during the Chile Triple Margin Expedition in 2010. Read the following mission logs for the story and some interesting insight and hope!

Requiem Explorator

<http://oceanexplorer.noaa.gov/explorations/10chile/logs/mar7a/mar7a.html>

Post-Triple Junction Blues

<http://oceanexplorer.noaa.gov/explorations/10chile/logs/mar7/mar7.html>

Epitaph for ABE:

Under the wide and restless sea,
Lies my grave, now let me be;
Glad did I work and now I rest,
Now by deadlines no longer stressed.
And I lay me down with a will.

This be the verse you grave for me;
"Here lies ABE where it longed to be;
Home is the sailor, home to the sea,
Here it rests, now let it be."

— Al Bradley (after Robert Louis Stevenson)

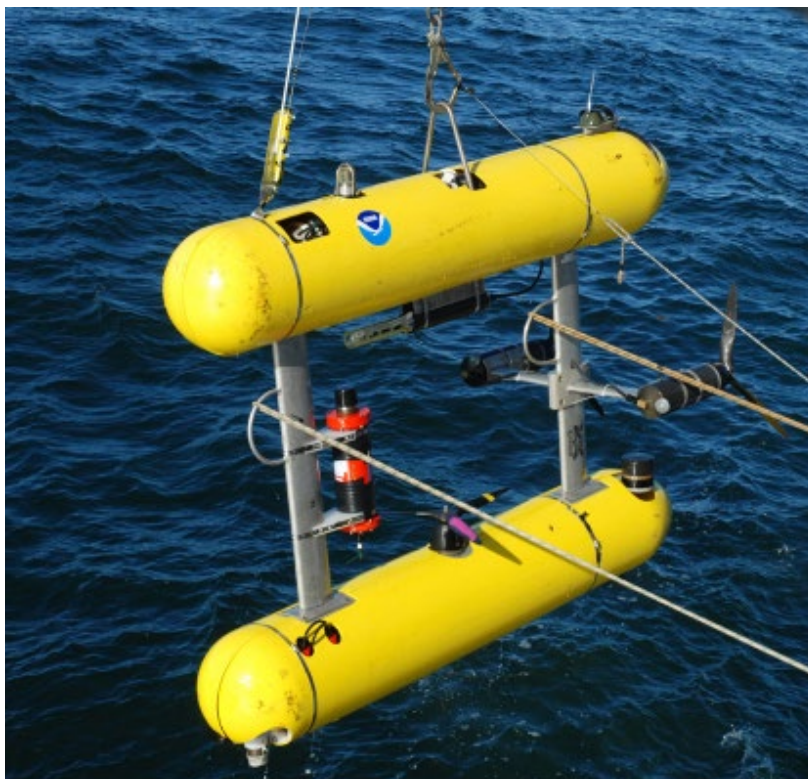

The AUV *Lucille* coming on board the research vessel. With negative buoyancy in the lower hull, and positive buoyancy in the upper hull, *Lucille* is able to remain stable in the unpredictable pitch and roll of the ocean while it follows the terrain of the bottom. Image courtesy of NOAA OER San Andreas Fault 2010 Expedition.
<http://oceanexplorer.noaa.gov/explorations/10sanandreas/background/auv/media/recovery1.html>

Autonomous underwater vehicles (AUVs) -- are another type of unmanned underwater vehicle that can operate without a pilot or cable to a ship or submersible. This independence allows AUVs to cover large areas of the ocean floor, as well as to monitor a specific underwater area over a long period of time. Typical AUVs can follow the contours of underwater mountain ranges, fly around sheer pinnacles, dive into narrow trenches, take photographs, and collect data and samples. Until recently, once an AUV was launched it was completely isolated from its human operators until it returned from its mission. Because there was no effective means for communicating with a submerged AUV, everything depended upon instructions programmed into the AUV's onboard computer. Today, it is possible for AUV operators to send instructions and receive data with acoustic communication systems that use sound waves with frequencies ranging roughly between 50 Hz and 50 kHz. These systems allow greater interaction between AUVs and their operators, but basic functions are still controlled by the computer and software onboard the AUV. Like ROVs, these underwater vehicles can be equipped with video photography equipment, sonars, water chemistry sensors, and a variety of other instruments. For additional information about AUVs, please see "What Are AUVs, and Why Do We Use Them?" by Denise Crimmins and Justin Manley (<http://oceanexplorer.noaa.gov/explorations/08auvfest/background/auvs/auvs.html>).



Diving Deeper: Additional Information about Key Topics

This section provides additional details and discussion of selected topics on modern reasons for ocean exploration.

Global Climate Change Overview

Since the middle of the 1800's, Earth's average temperature has warmed by about 1°F. This doesn't sound like much of a change, but it is important to realize that Earth's average temperature is now warmer than it has been at any time since at least 1400 AD. We say "at least" because 1400 AD is as far back as scientists have good estimates of temperatures. Other evidence suggests that Earth's temperature is warmer now than it has been in many thousands of years, maybe nearly 100,000 years. It is also important to remember that most averages include numbers that are higher and lower than the "average" value. So the warming in some areas can be much higher than 1°F, while other areas may actually be cooler.

According to the Annual 2016 Global Climate Report <https://www.ncdc.noaa.gov/sotc/global/201613> (NOAA, 2017), 2016 was:

- The warmest year in NOAA's 137-year series;
- The third consecutive year in which a new global annual temperature record was set;
- The fifth time in the 21st century a new record high annual temperature was set (along with 2005, 2010, 2014, and 2015); and
- The 40th consecutive year (since 1977) that the annual temperature has been above the 20th century average.

The Report also notes that all 16 years of the 21st century rank among the seventeen warmest on record, and the five warmest years have all occurred since 2010.

The Third National Climate Assessment (Melillo, Richmond, and Yohe, 2014 <http://nca2014.globalchange.gov>) includes findings that:

- Global climate is changing and this is apparent across the United States in a wide range of observations.
- The global warming of the past 50 years is primarily due to human activities.

This pink precious *Hemicorallium* in the family Coralliidae, found at ~2,400 meters (~7,875 feet), had most of its tentacles drawn in. Image courtesy of NOAA OER, 2017 Laulima O Ka Moana. <http://oceanexplorer.noaa.gov/oceanos/explorations/ex1706/dailyupdates/media/july25-2.html>

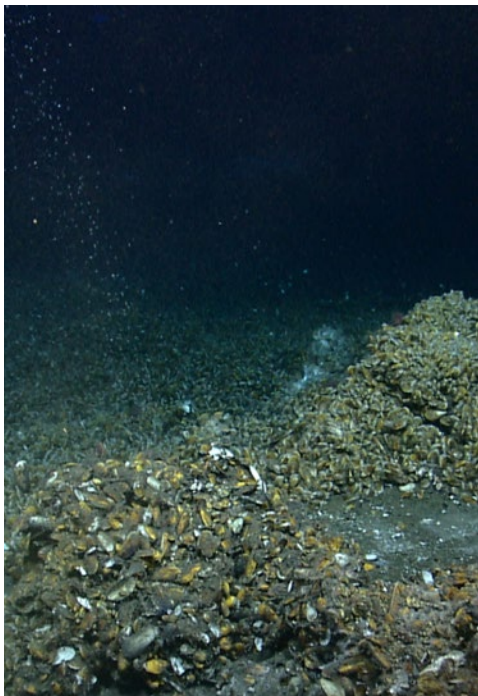

At 1400 meters deep, chemosynthetic mussels encrust a carbonate mound at a Norfolk Canyon seep. Bubbles that make up one of the observed water column plumes are visible on the left side. Image courtesy of NOAA OER, 2013 Northeast U.S. Canyons Expedition.

<http://oceanexplorer.noaa.gov/explorations/17atlantic-margin/media/norfolk.html>

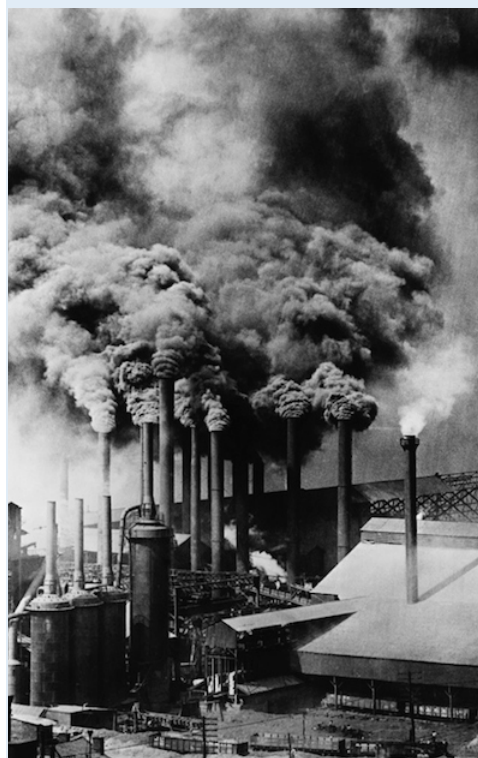

- Some extreme weather and climate events have increased in recent decades, and new and stronger evidence confirms that some of these increases are related to human activities.
- Human-induced climate change is projected to continue, and it will accelerate significantly if global emissions of heat-trapping gases continue to increase.
- Climate change threatens human health and well-being in many ways.
- Infrastructure is being damaged by sea level rise, heavy downpours, and extreme heat.
- Water quality and water supply reliability are jeopardized by climate change in a variety of ways that affect ecosystems and livelihoods.
- Climate disruptions to agriculture have been increasing and are projected to become more severe over this century.
- Climate change poses particular threats to Indigenous Peoples' health, well-being, and ways of life.
- Ecosystems and the benefits they provide to society are being affected by climate change. The capacity of ecosystems to buffer the impacts of extreme events like fires, floods, and severe storms is being overwhelmed.
- Ocean waters are becoming warmer and more acidic, broadly affecting ocean circulation, chemistry, ecosystems, and marine life.
- Planning for adaptation (to address and prepare for impacts) and mitigation (to reduce future climate change, for example by cutting emissions) is becoming more widespread, but current implementation efforts are insufficient to avoid increasingly negative social, environmental, and economic consequences.

Following is a brief review of a few key points.

Cause of the Observed Warming

Earth's climate is affected by a number of factors, including changes in Earth's orbit, solar variability, volcanoes, and the greenhouse effect. But the only factor that coincides with the warming trend of the last century is the observed increase in greenhouse gases, particularly carbon dioxide. There is no credible scientific debate about this: Since the start of the Industrial Revolution, atmospheric carbon dioxide concentrations have increased from 280 parts per million (ppm) to 400 ppm. Today, the global concentration of carbon dioxide is significantly higher than the natural range over the last 800,000 years of 170 – 300 ppm.

Cause of Increasing Atmospheric Carbon Dioxide

There is also no scientific debate about the source of increased atmospheric carbon dioxide. Humans burning fossil fuels release billions of tons of carbon into the atmosphere every year, and the quantity of fuels burned has been increasing for over 150 years (Access to data about fossil fuel and atmospheric carbon dioxide

trends can be found through ESS-DIVE, the U.S. Department of Energy's new archive at Lawrence Berkeley National Laboratory; see <https://eesa.lbl.gov/tag/ess-dive/>).

Volcanoes are sometimes suggested as an important source of atmospheric carbon dioxide. Scientists estimate that volcanoes (including underwater volcanoes) emit 200-485 million tons of carbon dioxide into the atmosphere each year (U.S. Geological Survey Volcano Hazards Program <https://volcanoes.usgs.gov/vhp/gas.html>). Emissions of carbon dioxide from human activities, however, are estimated at about 30 billion tons per year. So, the amount of carbon dioxide from human activities is more than 100 times greater than the amount of carbon dioxide emitted by volcanoes (<http://volcano.oregonstate.edu/man-versus-volcanos>). Further, if volcanoes had a significant impact on atmospheric carbon dioxide, data should show "spikes" on graphs of atmospheric carbon dioxide every time a volcano erupts; but such spikes are not present on these graphs.

It is also important to understand that concentrations of atmospheric carbon dioxide have fluctuated by over 100 ppm at various times in Earth's history, but these rises took place over 5,000 to 20,000 years. In contrast, the present increase of 120 ppm has happened in less than 220 years. Isotope analyses of carbon and oxygen atoms in atmospheric carbon dioxide molecules give additional clues to the cause of the present increase. These analyses show that the oxygen atoms in some of these molecules are much younger than the carbon atoms in the same molecule. Older carbon could only come from fossil fuel deposits, and the only way these deposits could become airborne is through combustion. Note that the amount of methane released by natural seepage as described below is much less than the amount of carbon released by combustion of fossil fuel, so natural seepage cannot account for the presence of older carbon.

Effect of Continued Increase in Atmospheric Carbon Dioxide

Global Temperature Increase

If atmospheric carbon dioxide concentrations continue to increase and nothing is done to reduce carbon dioxide emissions, global temperatures are projected to increase by 2.8° to 5.5°C (5° to 10°F) by 2100 (Melillo, Richmond, and Yohe, 2014 <http://nca2014.globalchange.gov>). So, the minimum expected temperature increase under these conditions is nearly four times the increase that has already been observed. The actual increase could be much greater, depending upon the influence of feedbacks. For example, decreasing ice and snow in polar regions means that less solar radiation will be reflected away from Earth's surface. This would result in more radiation being absorbed at the surface, and increased warming.



Top view of volcano erupting during daytime. Image courtesy Pexels.com.

<https://www.pexels.com/photo/top-view-of-volcano-erupting-during-daytime-73828/>

ARCTIC HAD WARMEST YEAR ON RECORD

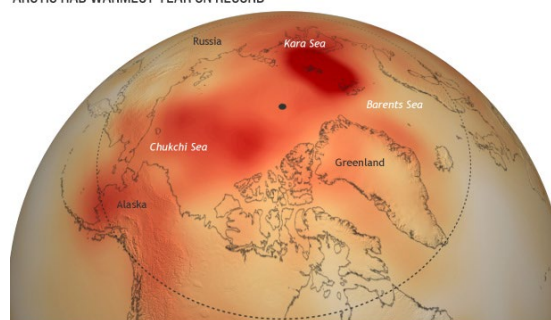

Oct 2015-Sep 2016

difference from average temperature
0 11°F
0 6°C

ARCTIC IS WARMING TWICE AS FAST AS THE GLOBAL AVERAGE

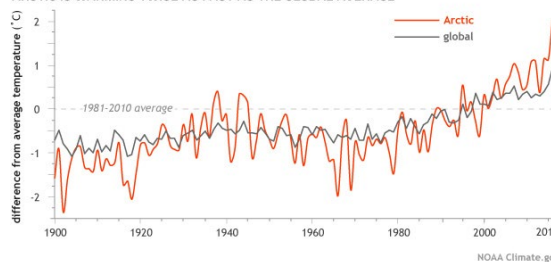

NOAA Climate.gov

(map) Temperatures across the Arctic from October 2015-September 2016 compared to the 1981-2010 average. (graph) Yearly temperatures since 1900 compared to the 1981-2010 average for the Arctic (orange line) and the globe (gray). NOAA Climate.gov map based on National Centers for Environmental Prediction (NCEP) reanalysis data from NOAA's Earth System Research Lab. Graph adapted from Figure 1.1 in the 2016 Arctic Report Card. <http://www.arctic.noaa.gov/Report-Card/Report-Card-2016>

(map) Stretching from Alaska to Scandinavia to Russia, and hundreds of feet deep in places, the Arctic's frozen soils--permafrost--contain twice as much carbon as what's already in the atmosphere. As the Arctic heats up, permafrost may become a major source of greenhouse gases, which would further accelerate global warming. (top middle) Permafrost is like a giant freezer for carbon: thousands of years worth of plant, animal, and microbe remains mixed with blocks of ice. Historically, only a shallow "active layer" thawed in the short summer. (top right) In today's warming Arctic, permafrost is thawing and the active layer is getting deeper. (bottom left) Warming in the growing season has increased plant growth and allowed plants to remove more carbon dioxide (CO₂) from the air during photosynthesis, but it is also thawing the frozen soils and stimulating decomposition of organic matter by soil microbes. Microbial activity releases the greenhouse gases CO₂ and methane (CH₄). (bottom right) When winter comes, the uppermost soil layer re-freezes quickly as air temperatures drop. But deeper layers, insulated from the frigid air, re-freeze more slowly. In the past decade, the parts of the Arctic tundra that are routinely observed have become a net source of carbon-containing greenhouse gases because microbial activity is continuing well into winter after plants go dormant. NOAA Climate.gov drawing. Permafrost map from National Snow and Ice Data Center (NSIDC). <https://www.climate.gov/news-features/understanding-climate/noaas-2016-arctic-report-card-visual-highlights>

Methane Hydrates

Warmer temperatures in the Arctic could also trigger another feedback process. Methane hydrates are a type of ice that contains methane molecules surrounded by a cage of frozen water molecules. Most methane hydrates are believed to exist in ocean sediments, but some are also found in high latitude soils called permafrost as well as in tropical wetlands. Increasing temperatures may cause methane hydrates to melt and release methane gas into the atmosphere. Since methane is a powerful greenhouse gas, and decomposes to form carbon dioxide, increased atmospheric methane could result in an increased greenhouse effect and additional warming of Earth's climate. In *Permafrost and Global Climate Change*, Holmes et al. (2015) http://whrc.org/wp-content/uploads/2015/06/PB_Permafrost.pdf conclude that "carbon emissions from thawing arctic permafrost will become substantial within decades, most likely exceeding current emissions from fossil fuel combustion," and the "emissions from permafrost could lead to out-of-control global warming."

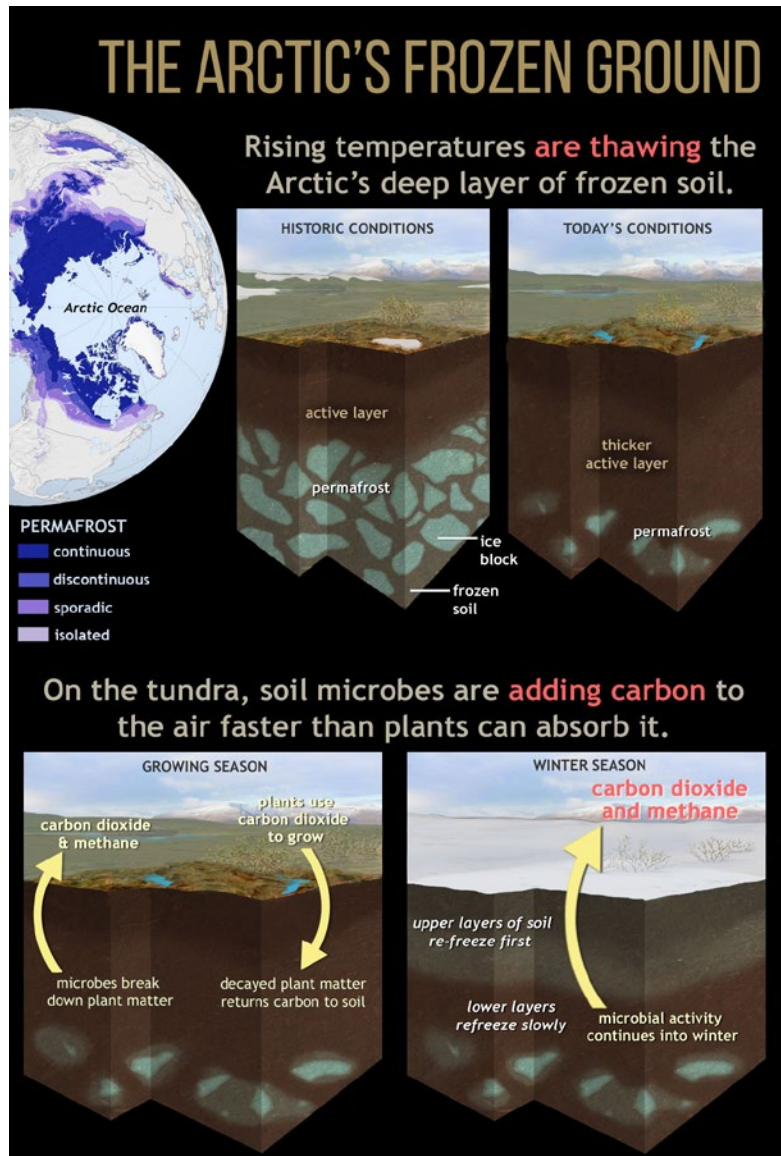

Ocean Temperature

A warmer atmosphere also means warmer temperatures in Earth's ocean. Since the solubility of carbon dioxide decreases as temperature rises, warmer temperatures could decrease carbon dioxide absorption by the ocean creating yet another feedback mechanism. Temperature has an opposite effect on the atmosphere's capacity for water vapor. Warmer air can hold more water vapor that evaporates from the ocean and land surface. Increased atmospheric water vapor has been observed from satellites, and is primarily due to human-caused changes in greenhouse gases (Santer, *et al.*, 2007). Water vapor is the most important and abundant greenhouse gas, and increased atmospheric water vapor can strengthen the greenhouse effect and result in additional warming. This effect may be counterbalanced to some extent if increased atmospheric water vapor causes increased cloud cover that reduces the amount of solar radiation reaching Earth's surface.

Ocean Circulation

Global climate is strongly influenced by interactions between Earth's atmosphere and ocean, but these interactions are complex and poorly understood. While the deep-ocean might seem far removed from the atmosphere, one of the most significant climatic influences results from the deep-ocean thermohaline circulation (THC).

The THC is driven by changes in seawater density. Two factors affect the density of seawater: temperature (the "thermo" part) and salinity (the "haline" part). Major features of the THC include:

- In the Northeastern Atlantic Ocean, atmospheric cooling increases the density of surface waters. Decreased salinity



Deep-ocean Thermohaline Circulation (THC)

World ocean thermohaline circulation (THC) is driven primarily by the formation and sinking of deep water in the Norwegian Sea. When salinity decreases because of excess precipitation, runoff, or ice melt, the conveyor belt will weaken or even shut down. Variations in the THC may lead to climate change in Europe and also affect other areas of the global ocean.

Source: <http://www.grida.no/resources/5238>; data from Climate Change 1995 – Impacts, adaptations and mitigation of climate change: Scientific-Technical Analyses. Contribution of Working Group 2 to the Second Assessment Report of the Intergovernmental Panel on Climate Change. United Nations Environment Programme and World Meteorological Organization. Cambridge University Press. 1996 Cartographer/Designer: Philippe Rekacewicz, UNEP/GRID-Arendal.

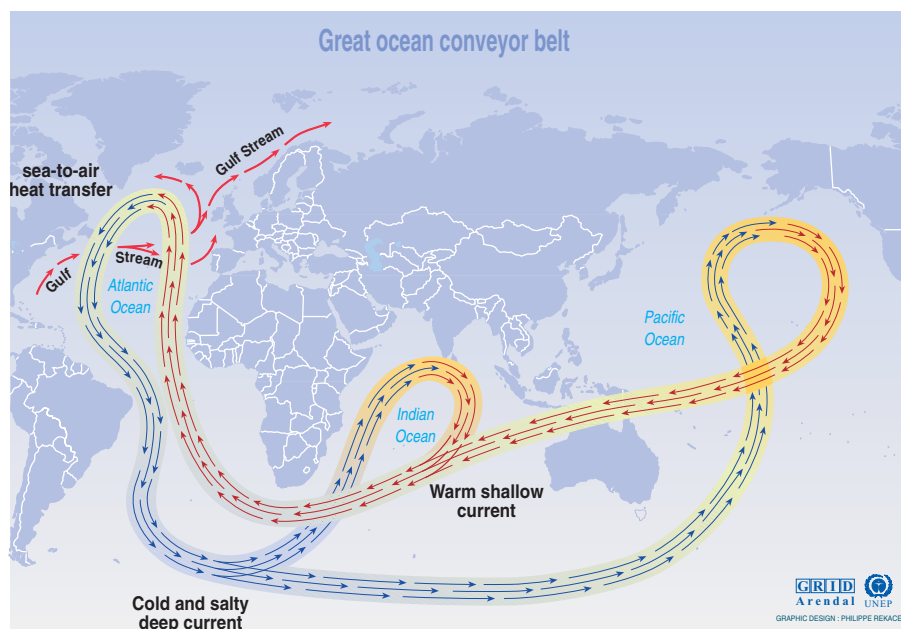

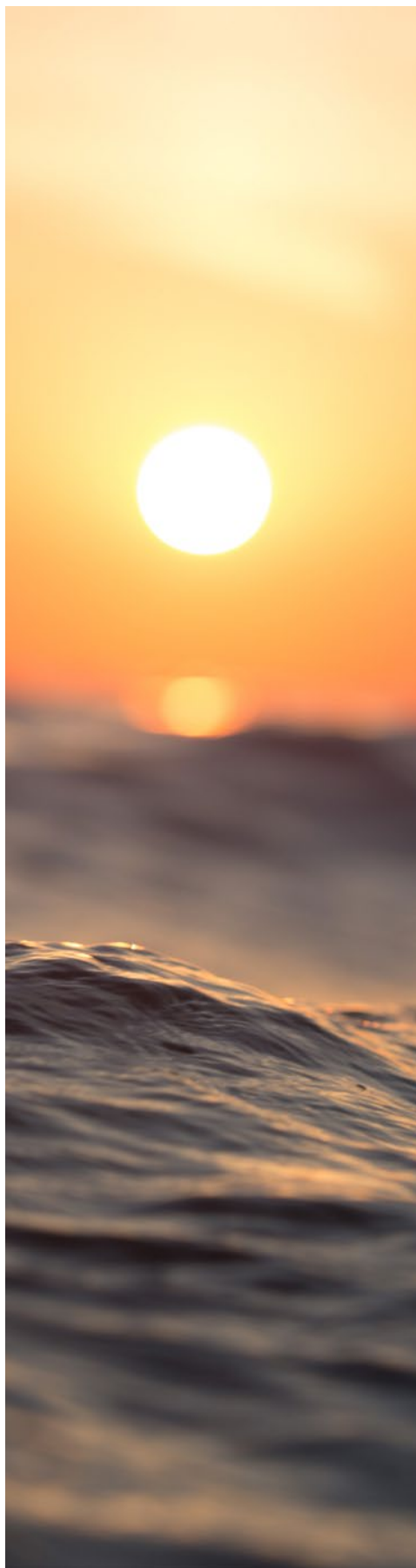

due to freshwater influx from melting ice partially offsets this increase (since reduced salinity lowers the density of seawater), but temperature has a greater effect, so there is a net increase in seawater density. The formation of sea ice may also play a role as freezing removes water but leaves salt behind causing the density of the unfrozen seawater to increase. The primary locations of dense water formation in the North Atlantic are the Greenland-Iceland-Nordic Seas and the Labrador Sea.

- The dense water sinks into the Atlantic to depths of 1,000 m and below, and flows south along the east coasts of North and South America.
- As the dense water sinks, it is replaced by warm water flowing north in the Gulf Stream and its extension, the North Atlantic Drift (note that the Gulf Stream is primarily a wind driven current, but portions of its circulation—the North Atlantic Drift—are also part of the THC).
- The deep south-flowing current combines with cold, dense waters formed near Antarctica, and flows from west to east in the Deep Circumpolar Current. Some of the mass deflects to the north to enter the Indian and Pacific Oceans.
- Some of the cold water mass is warmed as it approaches the equator, causing density to decrease. Upwelling of deep waters is difficult to observe, and is believed to occur in many places, particularly in the Southern Ocean in the region of the Antarctic Circumpolar Current.
- In the Indian Ocean, the water mass gradually warms and turns in a clockwise direction until it forms a west-moving surface current that moves around the southern tip of Africa into the South Atlantic Ocean.
- In the Pacific, the deepwater mass flows to the north on the western side of the Pacific basin. Some of the mass mixes with warmer water, warms, and dissipates in the North Pacific. The remainder of the mass continues a deep, clockwise circulation. A warm, shallow current also exists in the Pacific, which moves south and west, through the Indonesian archipelago, across the Indian Ocean, around the southern tip of Africa, and into the South Atlantic.
- Evaporation increases the salinity of the current, which flows toward the northwest, joins the Gulf Stream, and flows toward the Arctic regions where it replenishes dense sinking water to begin the cycle again.

The processes outlined above are greatly simplified. In reality, the deep-ocean THC is much more complex, and is not fully understood. Our understanding of the connections between the deep-ocean THC and Earth’s ecosystems is similarly incomplete, but most scientists agree that:

- The THC affects almost all of the world’s ocean (and for this reason, it is often called the “global conveyor belt”);
- The THC plays an important role in transporting dissolved oxygen and nutrients from surface waters to biological

communities in deep water; and

- The THC is at least partially responsible for the fact that countries in northwestern Europe (Britain and Scandinavia) are about 9°C warmer than other locations at similar latitudes.

In recent years, changes in the Arctic climate have led to growing concerns about the possible effects of these changes on the deep-ocean THC. Overall, the Arctic climate is warming more rapidly than elsewhere on Earth. Reasons for this include:

- When snow and ice are present, as much as 80% of solar energy that reaches Earth's surface is reflected back into space. As snow and ice melt, surface reflectivity (called "albedo") is reduced, so more solar energy is absorbed by Earth's surface;
- Less heat is required to warm the atmosphere over the Arctic because the Arctic atmosphere is thinner than elsewhere;
- With less sea ice, the heat absorbed by the ocean in summer is more easily transferred to the atmosphere in winter.

Dense water sinking in the North Atlantic Ocean is one of the principal forces that drives the circulation of the global conveyor belt. Since an increase in freshwater inflow (such as from melting ice) or warmer temperatures in these areas would weaken the processes that cause seawater density to increase, these changes could also weaken the global conveyor belt. Most climate models seem to show a general reduction in the Atlantic THC in response to global warming (e.g., Boulton et al., 2014).

Human Influences Apparent in Many Aspects of the Changing Climate

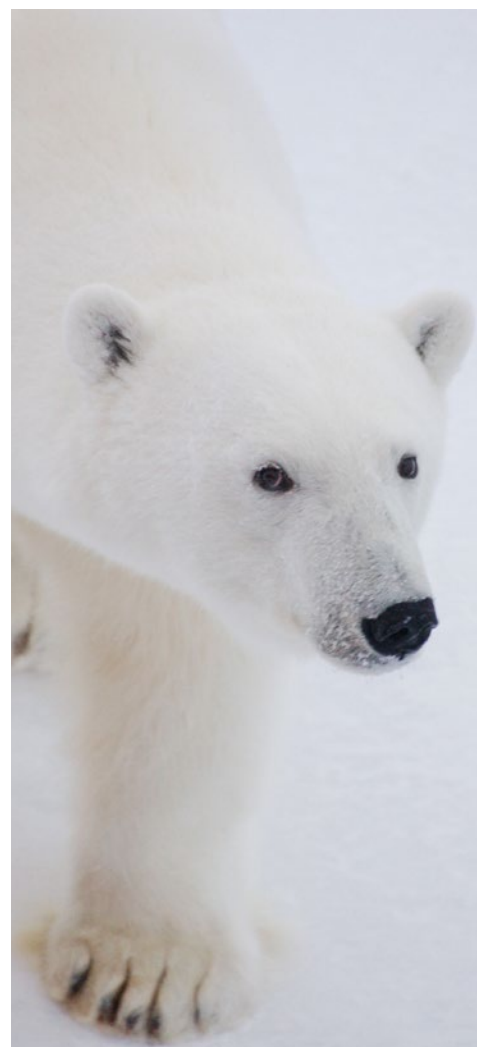
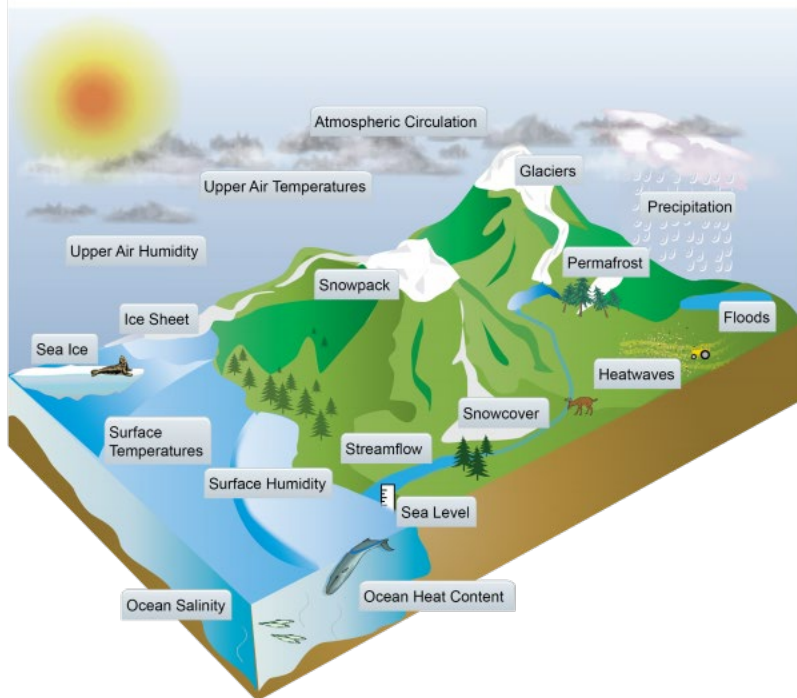

A polar bear wanders the ice pack. Image courtesy of Katrin Iken, UAF.

http://oceanexplorer.noaa.gov/explorations/16arctic/background/marine_mammals/media/polarbear.html

Figure shows examples of the many aspects of the climate system in which changes have been formally attributed to human emissions of heat-trapping gases and particles by studies published in peer-reviewed science literature. For example, observed changes in surface air temperature at both the global and continental levels, particularly over the past 50 years or so, cannot be explained without including the effects of human activities. While there are undoubtedly many natural factors that have affected climate in the past and continue to do so today, human activities are the dominant contributor to recently observed climate changes. (Figure source: NOAA NCDC).

<http://nca2014.globalchange.gov/report/appendices/climate-science-supplement#intro-section-2>

Scientists whose research was key to understanding the greenhouse effect and the impact of human activities on climate.
<http://www.globalchange.gov/browse/multimedia/early-scientists-who-established-scientific-basis-climate-change>

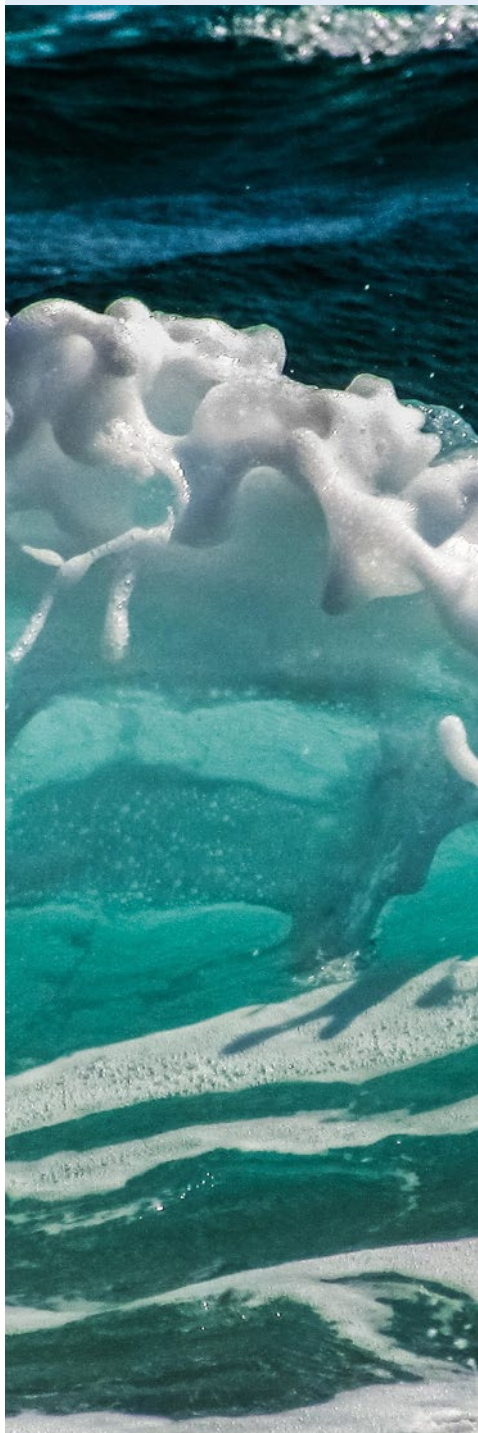

Early Scientists who Established the Scientific Basis for Climate Change



Ocean pH

Increasing atmospheric carbon dioxide is also having a serious effect on ocean pH. Each year, the ocean absorbs approximately 25% of the CO₂ added to the atmosphere by human activities. When CO₂ dissolves in seawater, carbonic acid is formed, which raises acidity. Ocean acidity has increased by 30% since the beginning of the Industrial Revolution, causing seawater to become corrosive to the shells and skeletons of many marine organisms as well as affecting the reproduction and physiology of others. See the lesson, Off Base, for additional discussion and references. http://oceanexplorer.noaa.gov/oceanos/edu/collection/media/wdwe_offbase.pdf

Impacts of Expected Climate Change if Trends Continue

The Intergovernmental Panel on Climate Change and U.S. Global Change Research Program (the leading providers of scientific advice to global and United States of America policy makers) have produced reports on some of the impacts that are occurring as a result of climate change as well as impacts that are anticipated if present trends continue. These impacts are summarized above. For additional information, please see Climate Change 2014: Synthesis Report (<http://www.globalchange.gov/browse/reports/ipcc-climate-change-2014-synthesis-report>), and Climate Change Impacts in the United States (<http://www.globalchange.gov/browse/reports/overview-climate-change-impacts-united-states-third-national-climate-assessment>)

Ocean Energy Overview

Earth's ocean contains enormous energy resources in its waters, in the adjacent atmosphere, and in the mantle and crust beneath the seafloor. Ocean energy resources include non-renewable sources such as oil and gas, as well as renewable sources, such as the energy of offshore winds, waves, and ocean currents. With the exception of oil and gas, ocean energy resources have not been extensively utilized in the United States, primarily because many of the technologies are not well-developed, nor have they been economically competitive with fossil fuels and nuclear power.

Underutilized ocean energy resources, though, are receiving increasing attention as technologies improve, prices of traditional energy sources continue to increase, and political considerations become more problematic. The following overview includes energy sources that are already being used in commercial-scale projects, as well as sources for which harvest technologies are still in the early stages of development.

Note: “Ocean energy” is sometimes used as a term that includes only forms of renewable energy that may be derived from the sea. The following discussion also includes non-renewable methane hydrates, because of the significant quantity of energy that is potentially available from these substances, and the widespread occurrence of methane hydrates in deep-sea environments.

Waves

Significant amounts of kinetic energy exists in the moving waves of the ocean. In fact, waves have the highest energy density of any renewable resource. Wave-power is particularly rich in areas along the western coasts of Scotland, northern Canada, southern Africa, Australia, and the east, west, and Alaskan coasts of the United States. Devices to capture wave energy are designed to extract energy directly from the surface motion of ocean waves or from pressure fluctuations below the surface caused by waves. Most of these devices being tested at commercial scales use one of the following technologies:

- Terminator devices are oriented perpendicular to the direction of wave travel and are analogous to a piston moving inside a cylinder. An Oscillating Water Column is a type of terminator in which water enters through a subsurface opening into a chamber with air trapped above it. Wave action causes the column of water to move up and down in the chamber, forcing the air through an opening to rotate a turbine. Another type of terminator, called an Overtopping Device, consists of an enclosed reservoir that is filled by overtopping waves. Water collected in the reservoir is released back into the ocean through an outlet system that uses the energy of the falling water to rotate a turbine.
- Point absorbers are floating structures with components that move relative to each other due to wave action (for example, a floating piston inside a fixed cylinder). The motion of the components is used to drive electromechanical or hydraulic energy converters.
- Attenuators are segmented floating structures oriented parallel to the direction of the waves. As waves pass under the attenuator, the connections between segments flex and this flexing motion is transmitted to hydraulic pistons that drive electric generators inside the segments.
- Overtopping devices capture water from incoming waves in reservoirs to create a slight buildup of water pressure similar to a plastic wading pool. The captured water is released through a hydro turbine to generate electricity.



A terminator device



A point absorber



An attenuator device



An overtopping device.
All images on this page from:
<https://www.boem.gov/Ocean-Wave-Energy/>

You can see illustrations and animations of these devices at <https://www.boem.gov/Ocean-Wave-Energy/>

Tidal Energy

Humans have been using the energy of ocean tides since at least the eighth century AD. The basic principle is to build a dam (called a barrage) across an estuary or small tidal stream so that water is trapped behind the dam when the tide rises. Then when the tide falls, the trapped water can be released so that it turns a water wheel that can do work such as mill grains or turn a turbine to generate electricity. A tidal range of at least 10 feet is needed for economical electricity generation, which limits the number of locations where it is feasible to capture tidal energy in this way. One such location is the La Rance River estuary on the northern coast of France, where a tidal energy generating station has been in operation since 1966. Smaller stations have been established in Nova Scotia, Canada; China; South Korea; and Murmansk, Russia.

An alternative approach for capturing tidal energy is to place turbines in offshore tidal streams. The technology is similar to that used for capturing energy from ocean currents.



Artist rendering of ocean current turbines.
<https://www.boem.gov/Ocean-Current-Energy/>

Current Energy

Ocean currents, such as the Gulf Stream, Florida Straits Current, and California Current, are driven by wind, solar heating, and density variations of large ocean water masses. These currents are relatively constant and flow in one direction only, while the velocity of tidal currents closer to shore varies constantly and their direction changes several times each day. Ocean currents contain an enormous amount of energy; for example, it has been estimated that all of Florida's electrical needs could be met by capturing less than 1% of the available energy in the Gulf Stream.

Technology to capture ocean current energy is presently in the early stages of development, and there are no commercial scale turbines producing electricity for regular distribution. Experimental projects include submerged water turbines similar

to wind turbines, as well as doughnut-shaped turbines with blades resembling those seen in jet engines (see <https://www.boem.gov/Ocean-Current-Energy/> for illustrations).

Thermal Energy

I owe all to the ocean; it produces electricity, and electricity gives heat, light, motion, and, in a word, life to the *Nautilus*.

— Jules Verne, 1870

Captain Nemo's explanation of engineering aboard the *Nautilus* in 20,000 Leagues Under the Sea provides the first documented reference to the use of ocean chemistry to produce electricity. A

decade later, French Engineer Jacques D'Arsonval suggested the possibility of using ocean temperature differences to produce electricity.

This idea is based on the fact that Earth's ocean covers slightly more than 70 percent of the Earth's surface, making the ocean Earth's largest collector and storage system for solar energy. On an average day, 60 million square kilometers (23 million square miles) of tropical seas absorb an amount of solar radiation equal in heat content to about 250 billion barrels of oil (in 2016, the world daily consumption of oil is estimated to have been 96 million barrels). So, harvesting even a very small fraction of the radiant energy absorbed by Earth's ocean could have a significant impact on human energy needs.

Ocean Thermal Energy Conversion (OTEC) is a technology to convert solar radiation absorbed by the ocean into electric power. The basis for this concept is that surface ocean waters receive most solar radiation and consequently are warmer than deeper waters. Where the temperature difference between surface water and deep water is about 20°C (36°F), an OTEC system can produce a significant amount of power.

D'Arsonval's original idea was to pump warm seawater through a heat exchanger to vaporize a fluid with a low boiling point (such as ammonia), and then use the expanding vapor to turn an electricity-generating turbine. Cold seawater would be pumped through a second heat exchanger to condense the vapor back into a liquid, which would be recycled through the system. This type of OTEC is called a closed-cycle system. Pilot-scale closed-cycle OTEC

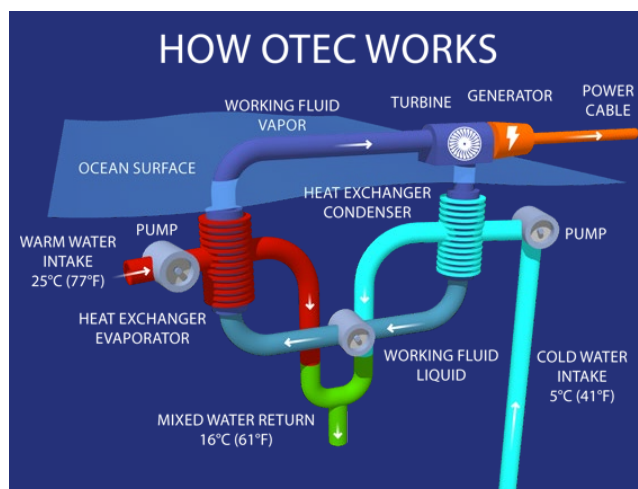

A basic closed-cycle Ocean Thermal Energy Conversion (OTEC) plant is shown in the figure at right. Warm seawater passes through an evaporator and vaporizes the working fluid, ammonia. The ammonia vapor passes through a turbine which turns a generator making electricity. The lower pressure vapor leaves the turbine and condenses in the condenser connected to a flow of deep cold seawater. The liquid ammonia leaves the condenser and is pumped to the evaporator to repeat the cycle. Image courtesy Makai Ocean Energy Research Center. <https://www.makai.com/ocean-thermal-energy-conversion/>

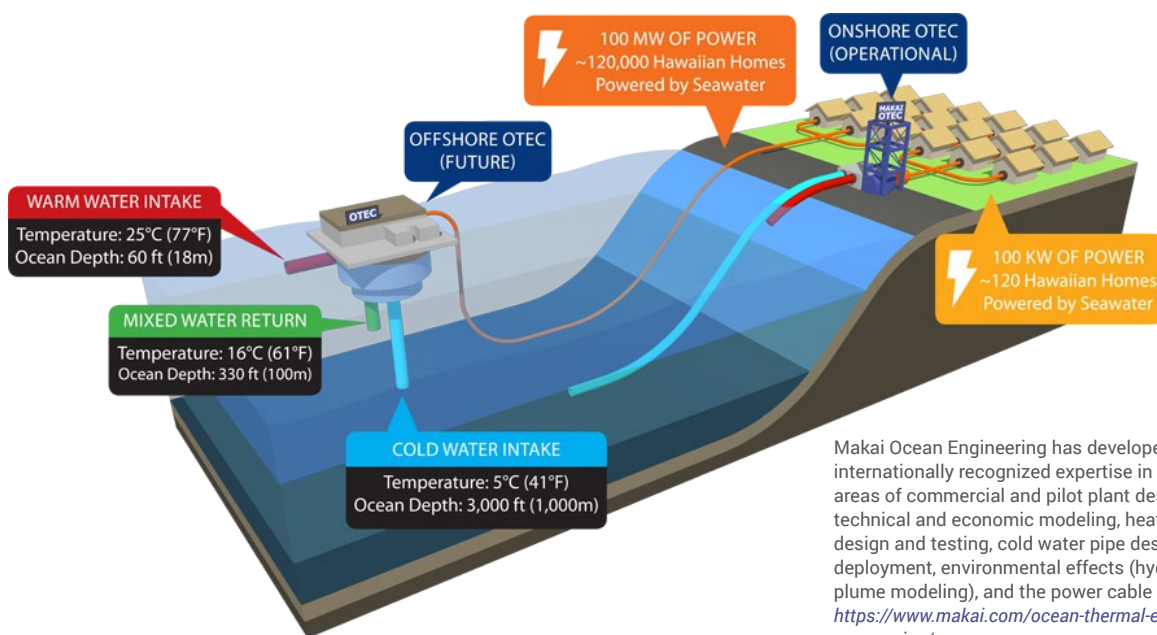

Makai Ocean Engineering has developed internationally recognized expertise in OTEC in the areas of commercial and pilot plant designs, overall technical and economic modeling, heat exchanger design and testing, cold water pipe design and deployment, environmental effects (hydro- and bioplume modeling), and the power cable to shore. <https://www.makai.com/ocean-thermal-energy-conversion/>

systems have been successful in producing electric power.

Open-cycle OTEC systems use warm seawater that boils when it is placed in a low-pressure container. The expanding steam drives an electricity-generating turbine. Cold seawater is used to condense the steam back to water. This water is almost pure fresh water, since the salt is left behind in the low-pressure container when the seawater boils. Experimental open-cycle OTEC plants have also successfully produced electric power, in some cases with energy conversion efficiencies as high as 97%. Hybrid OTEC systems combine some features of both closed-cycle and open-cycle systems: Warm seawater enters a vacuum chamber where it is evaporated into steam (similar to the open-cycle evaporation process) that is used to vaporize a low-boiling-point fluid (as in closed-cycle system) that drives a turbine to produce electricity.

Another type of thermal energy comes from the earth itself. This geothermal energy is produced in Earth's core by the decay of radioactive particles. Earth's core consists of an inner mass of solid iron and an outer core of melted rock called magma. The outer core is surrounded by Earth's crust, which is 3 - 5 miles thick under the ocean and 15 - 35 miles thick under the continents. Volcanoes occur where magma comes close to the surface of the crust. In some areas, water enters cracks in the crust, comes close to hot magma, and turns into boiling hot water or steam. The heated water may emerge at the surface of Earth's crust as a hot spring, or may erupt into the air as a geyser. Geothermally heated water has been used for centuries to heat buildings, for bathing, and for cooking, and more recently to generate electricity.

Most geothermal activity in the world occurs along the boundaries of tectonic plates encircling the Pacific Ocean, in an

Geothermal energy has been used for centuries. Most of Earth's geothermal activity occurs along the Ring of Fire, which has been investigated by Ocean Explorer expeditions since 2002. This image shows an area on the summit of the West Mata Volcano erupting in 2009. Image courtesy of NOAA/NSF/WHOI.
http://oceanexplorer.noaa.gov/explorations/12fire/background/hires/mata_2009_hires.jpg



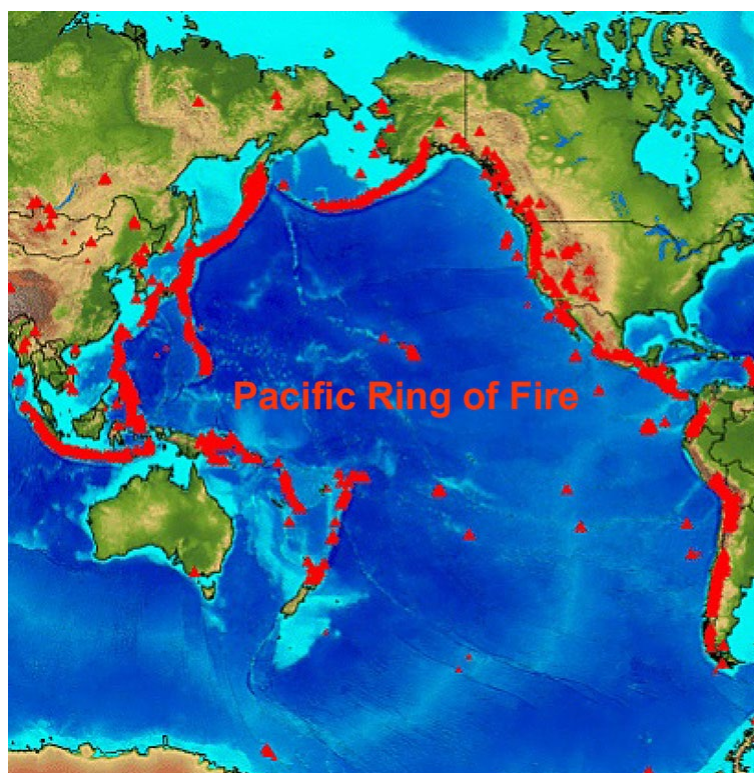

area called the Ring of Fire. This area has been the subject of NOAA-funded research expeditions since 2002 documenting numerous underwater volcanoes, hydrothermal vent fields and other geothermal features, many of which were unexplored prior to these expeditions. Technology for capturing geothermal energy from these sources is in the early stages of development, but one system has been tested in the caldera of the Axial Volcano off the Oregon coast, at least one U.S. patent has been awarded for a 'hydrothermal energy and deep-sea resource recovery system', and a conceptual design for a 'deep-sea energy park' has been proposed. (See *Impacts of anthropogenic disturbances at deep-sea hydrothermal vent ecosystems: A review* by Cindy Van Dover, 2014 <http://www.sciencedirect.com/science/article/pii/S0141113614000506>)

Off Shore Solar

The sun is the primary energy source for all photosynthetic ecosystems, and also drives winds, waves, and deep-ocean currents. In fact, energy from wind, waves, currents, and OTEC could be considered as indirect forms of solar energy (similarly, tidal current energy could be considered as an indirect form of gravitational energy, since tidal currents are driven by gravitational forces between Earth, its moon, and the sun). Solar energy technologies that are presently used in land-based installations may also be developed for offshore use.

You can see illustrations of solar power devices at <https://www.boem.gov/Offshore-Solar-Energy/>.

Map of the all the volcanoes around the Pacific (red triangles) making up the Ring of Fire. Image courtesy of NOAA/PMEL, NSF, Submarine Ring of Fire 2014 - Ironman.

http://oceanexplorer.noaa.gov/explorations/14fire/background/seamounts/media/volcano_map.html

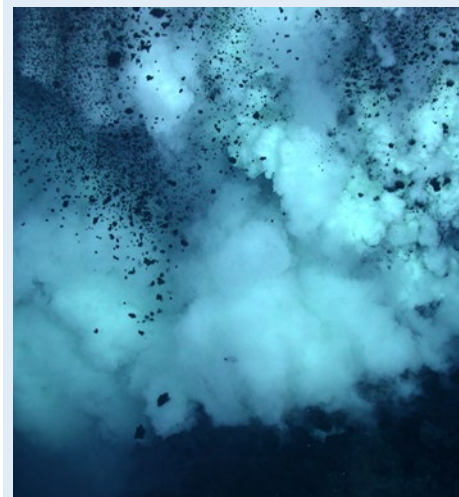

NW Rota-1 seamount has been observed erupting explosively on previous visits. Image courtesy of NOAA/PMEL, NSF, Submarine Ring of Fire 2014 - Ironman,

http://oceanexplorer.noaa.gov/explorations/14fire/background/missionplan/media/nw_rota_lavabombs.html



The first U.S. off shore wind farm, built off Block Island, R.I. in 2016.
<http://dwwind.com/attachment/?projects=block-island-wind-farm#/1>

Pressure Retarded Osmosis (PRO) uses the selective diffusion of water across a membrane in order to pressurize seawater. Freshwater and seawater are placed on either side of a membrane, and the seawater side is pressurized. As the seawater side increases in pressure and decreases in salinity, part of the water is discharged through a turbine while the rest is put in a pressure exchanger to pressurize the incoming seawater, as illustrated below.
<http://www.climatetechwiki.org/technology/jiqweb-ro>

Off Shore Wind

For many centuries, humans have harnessed wind power to do various types of work, from pushing ships through the ocean, to pumping water, to processing agricultural products. More recently, wind has been used to produce electricity. Most wind turbines have been located on land, but offshore wind turbines are being used in a number of countries, including Denmark and the United Kingdom where large offshore wind facilities have been installed to take advantage of consistent winds. Offshore winds tend to flow at higher speeds than onshore winds, which means that offshore wind turbines have the potential to produce more electricity than land-based installations. The first U.S. offshore wind farm became operational in December 2016 off the coast of Block Island, Rhode Island. Additional projects are being planned in the Northeast, Mid-Atlantic, Great Lakes, Gulf of Mexico, and Pacific Coast regions.

For more information, see <https://www.boem.gov/Offshore-Wind-Energy/>.

Salinity Gradient (Osmotic) Energy

When fresh water and salt water are separated by a semipermeable membrane, water will move through the membrane into the salt solution (only water molecules can pass through a semipermeable membrane). This water movement is driven by a force called osmotic pressure, which is defined as

the pressure that would have to be applied to the salt water solution to prevent the influx of water through the semipermeable membrane. Influx of fresh water will increase the volume of the salt water. If the salt water is in a closed container, the volume cannot increase because water is essentially incompressible, and the pressure in the container will rise until it equals the osmotic pressure. If the pressure in the container is released, it can be used to drive a turbine to generate electricity. This method for utilizing salinity gradient energy is called Pressure Retarded Osmosis.

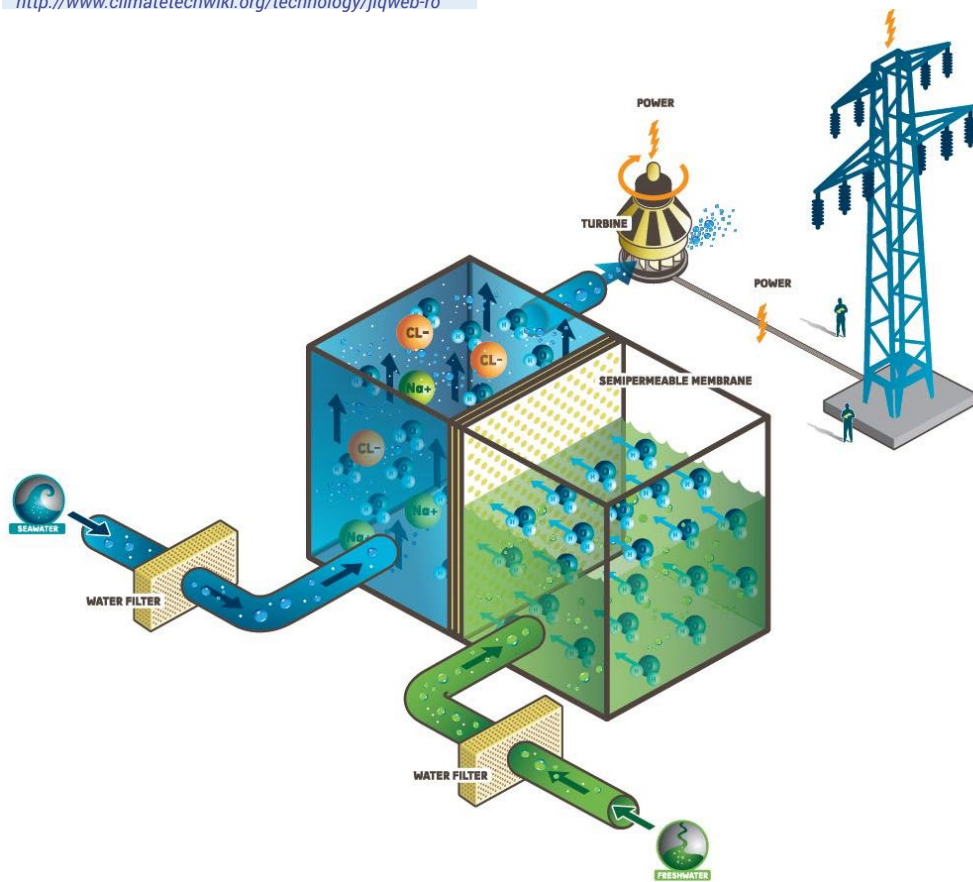

Reverse Electrodialysis is another salinity gradient technique that uses a series of anion and cation exchange membranes (negatively charged ions can pass through anion exchange membranes; positively charged ions can pass through cation exchange membranes). When fresh water and salt water are separated by an anion exchange membrane, negatively charged ions will move from the salt water into the fresh water until the concentration on both sides of the membrane are equal. Similarly, when fresh water and salt water are separated by a cation exchange membrane, positively charged ions will move from the salt water into the fresh water until the concentration on both sides of the membrane are equal. A reverse electrodialysis cell is essentially a salt battery with alternating containers of fresh water and salt water separated by an alternating series of anion and cation exchange membranes. If electrodes are placed at opposite ends of the cell and connected to an electric circuit, a voltage will be produced in the circuit.

Development of salinity gradient energy technology is still in its infancy, though the potential energy is large in locations where rivers mix with salt water. For additional information, see Salinity Gradient Energy: Current State and New Trends, by O. Schaetzle and C. Buisman (2015) <http://engineering.org.cn/EN/10.15302/J-ENG-2015046>.

Methane Hydrates and Other Hydrocarbons

Methane hydrate is a type of clathrate, a chemical substance in which the molecules of one material (water, in this case) form an open lattice that encloses molecules of another material (methane) without actually forming chemical bonds between the two materials. Methane is produced in many environments as a by-product of the anaerobic metabolism of methanogenic Archaea through which the microorganisms break down organic material contained in once-living plants and animals. When this process takes place in deep ocean sediments, methane molecules are surrounded by water molecules, and conditions of low temperature and high pressure allow stable ice-like methane hydrates to form.

Methane hydrate deposits are significant for several reasons. A major interest is the possibility of methane hydrates as an energy source. The U.S. Geological Survey has estimated that on a global scale, methane hydrates may contain roughly twice the carbon contained in all reserves of coal, oil, and conventional natural gas combined. In addition to their potential importance as an energy source, scientists have found that methane hydrates are associated with unusual and possibly unique biological communities. In September 2001, the Ocean Exploration Deep East Expedition explored the crest of the Blake Ridge at a depth of 2,154 m, and found methane hydrate-associated communities containing previously unknown species that may be sources of beneficial pharmaceutical materials.

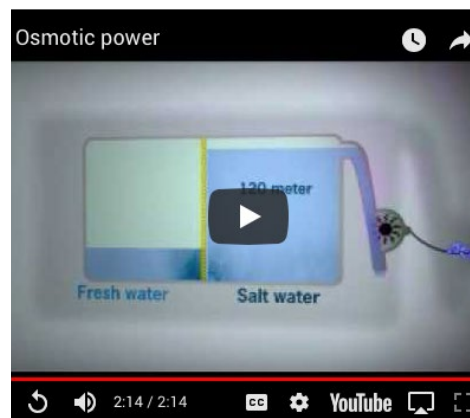

This video illustrates the Pressure Retarded Osmosis (PRO) concept.

https://www.youtube.com/watch?time_continue=134&v=T00KVpPLNGQ

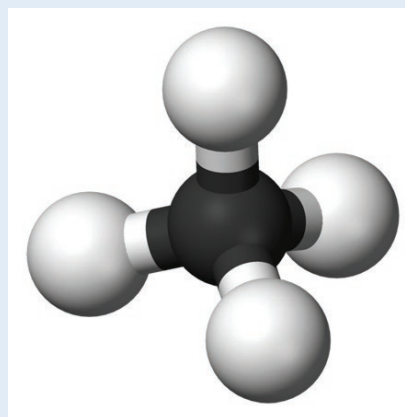

Methane is composed of one carbon atom surrounded by four hydrogen atoms. It is the simplest hydrocarbon. Image courtesy of NOAA OER, INSPIRE: Chile Margin 2010.

<http://oceanexplorer.noaa.gov/explorations/10chile/background/methane/media/methane1.html>

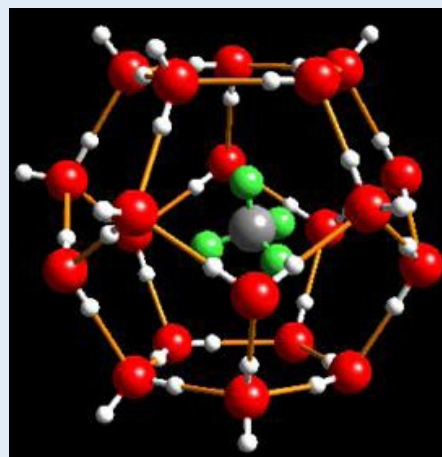

Water molecules (1 red oxygen and 2 white hydrogens) form a pentagonal dodecahedron around a methane molecule (1 gray carbon and 4 green hydrogens). This represents 2 of the 8 parts of the typical Structure I gas hydrate molecule.

<https://woodshole.er.usgs.gov/project-pages/hydrates/primer.html>

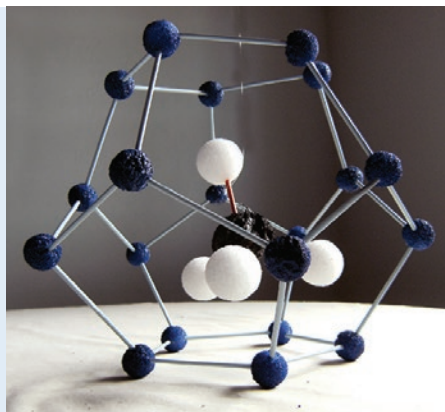

Build your own model of a methane hydrate! Find out how in the *What's The Big Deal?* lesson. Image courtesy Mellie Lewis.

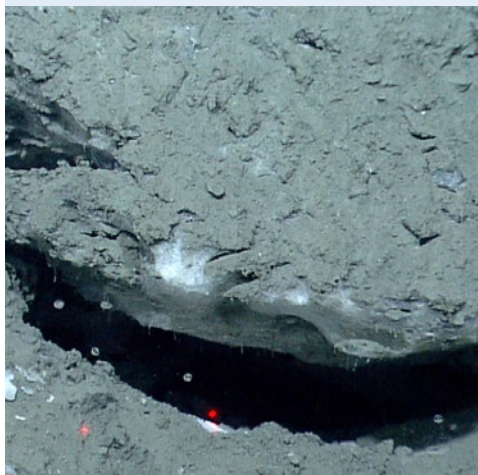
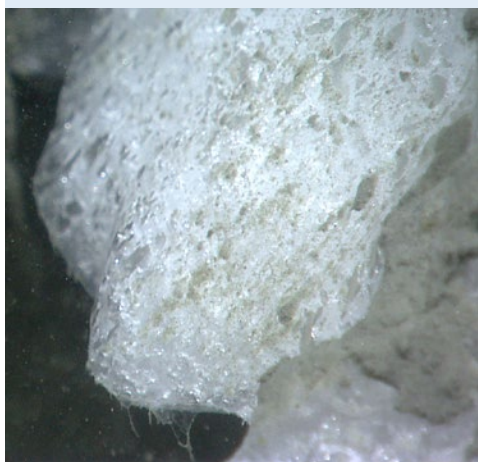

Gas hydrates found at the seafloor on July 11 and July 12, 2013 had different forms. On the top image, a small piece of massive gas hydrate formed above leaking methane. In the bottom image, white gas hydrate formed under a rock overhang. Bubbles being emitted from the seafloor are visible in the shadow below the rock. Laser scale denotes 10 centimeters. Image courtesy of NOAA OER, 2013 Northeast U.S. Canyons Expedition.

<http://oceanexplorer.noaa.gov/oceanos/explorations/ex1304/logs/july12/media/hydrate1.html>

<http://oceanexplorer.noaa.gov/oceanos/explorations/ex1304/logs/july12/media/hydrate2.html>

Methane hydrates remain stable in deep-sea sediments for long periods of time; but if the surrounding temperature rises the clathrates may become unstable and release free methane gas. This is probably happening now in at least two settings. In the deep ocean, as sediments become deeper and deeper they are heated by the Earth's core; eventually to a point at which free methane gas is released (at a water depth of 2 km, this point is reached at a sediment depth of about 500 m). Methane hydrates are also widespread on continental margins and permafrost areas. Here, oceanic and atmospheric warming may also make hydrates unstable and lead to methane release into overlying sediments and soils (Ruppel and Kessler, 2017). In deepwater sediments, pressurized methane remains trapped beneath hundreds of meters of sediments that are cemented together by still-frozen methane hydrates. On continental shelves, methane may be released as bubbles at the seafloor. Areas where this is happening are called methane seeps. Not all methane seeps are caused by decomposing methane hydrates; many are probably the result of microbial activity in shallow sediments (Ruppel and Hamilton, 2014).

While these discoveries are exciting, there has also been concern about the possible effects of methane release. In 1995, Australian paleoceanographer Gerald Dickens suggested that a sudden release of methane from submarine sediments during the Paleocene Epoch (at the end of the Tertiary Period, about 55 million years ago) caused a greenhouse effect that raised the temperatures in the deep ocean by about 6° C. The result was the extinction of many deep-sea organisms known as the Paleocene extinction event. Kirschvink and Raub, (2003), on the other hand, suggested that methane released from methane hydrates is a possible cause of the dramatic increase in biodiversity that took place during the Cambrian Period. Other concerns have focused on the possibility that sudden release of methane might trigger submarine landslides that could cause disastrous tsunamis.

Recent research, however, has found that while large quantities of methane may have been released at various points in Earth's history, the time scale of these releases is on the order of thousands of years, rather than sudden catastrophic releases (Archer, 2007). The available evidence also does not show a strong relationship between submarine landslides and methane emissions (Talling et al., 2014). While current warming of ocean waters is probably causing some gas hydrate deposits to break down, this is unlikely to lead to massive amounts of methane being released to the atmosphere because the annual emissions of methane to the ocean from these deposits is very small, and most of the methane released by gas hydrates never reaches the atmosphere (Ruppel and Kessler, 2017). Methane in the water column, though, can be oxidized to carbon dioxide, which increases the acidity of ocean waters and reduces oxygen levels.

At present, there is no known technology for tapping methane hydrates as a source of useful energy. Current research in the U.S. and other countries is focused on the feasibility of methane hydrates as an energy source, as well as interactions between climate change and gas hydrates (Ruppel and Hamilton, 2014). See <https://www.netl.doe.gov/File%20Library/Publications/factsheets/Program/Program-099.pdf> for information about methane hydrate R&D projects in 2017.

Besides methane hydrates, regions such as the Gulf of Mexico produce significant quantities of petroleum that are associated with unique deep-sea ecosystems. In the Gulf of Mexico, these ecosystems are typically found in areas with rocky substrates or “hardgrounds.” Most of these hardbottom areas are found in locations called cold seeps where hydrocarbons are seeping through the seafloor. Microorganisms are the connection between hardgrounds and cold seeps. When microorganisms consume hydrocarbons under anaerobic conditions, they produce bicarbonate which reacts with calcium and magnesium ions in the water and precipitates as carbonate rock. Two types of ecosystems are typically associated with deepwater hardgrounds in the Gulf of Mexico: chemosynthetic communities and deep-sea coral communities. Hydrocarbon seeps may indicate the presence of undiscovered petroleum deposits, so the presence of these ecosystems can indicate potential sites for exploratory drilling and possible development of offshore oil wells. At the same time, these are unique ecosystems whose importance is presently unknown. For more information about deep-sea ecosystems in the Gulf of Mexico, see Lessons from the Deep: Exploring the Gulf of Mexico’s Deep-Sea Ecosystems Education Materials Collection (<http://oceanexplorer.noaa.gov/edu/guide/welcome.html>) and the Exploration of the Gulf of Mexico 2014 expedition (<http://oceanexplorer.noaa.gov/oceanos/explorations/ex1402/welcome.html>).

Human Health Overview

Almost all drugs derived from natural sources come from terrestrial plants. But recent explorations have found that some marine invertebrates such as sponges, tunicates, ascidians, bryozoans, and octocorals can also produce powerful drug-like substances. In fact, these animals produce more antibiotic, anti-cancer, and anti-inflammatory substances than any group of terrestrial organisms. Chemicals produced by marine animals that may be useful in treating human diseases include:

Ecteinascidin – Extracted from tunicates; approved as Ylondelis for treatment of breast, prostate, and pediatric cancers; acts by blocking transcription of DNA

Topsentin – Extracted from the sponges *Topsentia genitrix*, *Hexadella* sp., and *Spongosorites* sp.; effective against viruses and certain tumors; inhibits DNA and RNA synthesis

Lasonolide – Extracted from the sponge *Forcepia* sp.; high and selective cytotoxicity against mesenchymal cancer

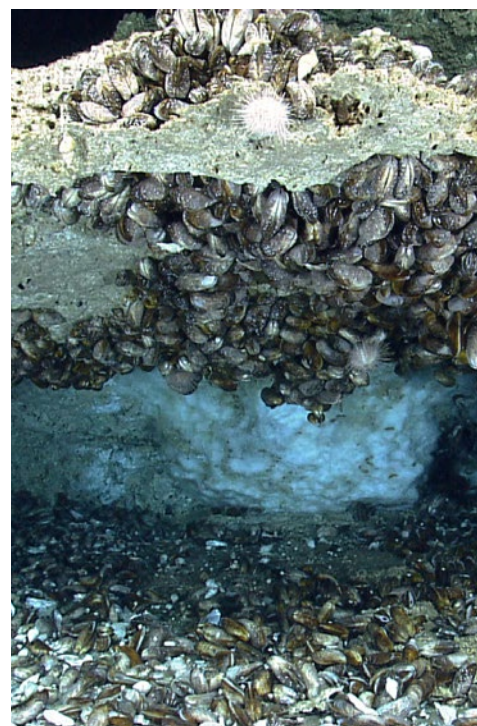

The first dive of the 2014 Gulf of Mexico Expedition had a fantastic “amphitheater of chemosynthetic life.” There were bathymodiolus mussels, methane hydrate or ice, and ice worms. There were also a number of sea urchins, sea stars, and fish in this area. Most impressive was the large accumulation of hydrate mussels on the underside of the ledge. Image courtesy of NOAA OER, Gulf of Mexico 2014 Expedition.

http://oceanexplorer.noaa.gov/oceanos/explorations/ex1402/logs/highlight_imgs/media/amphitheater.html



Laboratory cultures of deep-sea vent microbes: isolation and purification of organisms on solid agar media. Image courtesy of Oregon State University.

http://oceanexplorer.noaa.gov/explorations/12fire/background/hires/lab_cultures_hires.jpg

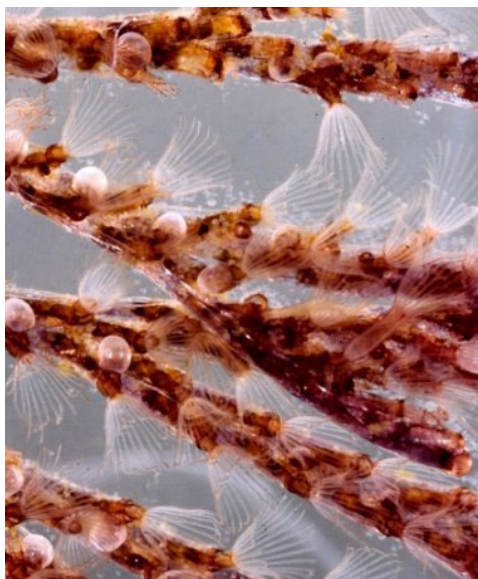

The spiral-tufted bryozoan (*Bugula neritina*) is being studied for a potential Alzheimer's disease and cancer drug—but it's not the bryozoan that makes the chemical. The chemical, found in the bryozoan's tissues, is produced by its bacterial endosymbiont, *Candidatus Endobugula sertula*. In exchange for a protective home in the bryozoan's tissues, the bacteria produces a chemical called a bryostatin that makes the bryozoan larvae taste bad to predators. Image courtesy of Lovell and Libby Langstroth © California Academy of Sciences.
<http://ocean.si.edu/ocean-photos/bryozoans-medical-endosymbiont>



Ziconotide is a chemical derived from the *Conus magus* (cone shell) toxin that acts as a painkiller with a potency 1000 times that of morphine. Discovered by Dr. Baldomero Olivera at University of Utah, it was developed for treatment of chronic and intractable pain caused by AIDS, cancer, neurological disorders and other maladies, and was approved by the U.S. Food and Drug Administration in December 2004 under the name Prialt. Ziconotide works by blocking calcium channels in pain-transmitting nerve cells, rendering them unable to transmit pain signals to the brain. It is administered through injection into the spinal fluid.
https://en.wikipedia.org/wiki/Conus_magus

cells, including leukemia, melanomas and glioblastomas; interferes with cell mitosis

Discodermalide – Extracted from deep-sea sponges belonging to the genus *Discodermia*; anti-tumor agent; acts by interfering with microtubule networks

Bryostatin – Extracted from the bryozoan *Bugula neritina*; potential treatment for leukemia, non-Hodgkin's lymphoma, and Alzheimer's disease; acts as a differentiating agent, forcing cancer cells to mature and thus halting uncontrolled cell division

Pseudopterosins – Extracted from the octocoral *Pseudopteroorgia elisabethae* (sea whip); anti-inflammatory and analgesic agents that reduce swelling and skin irritation and accelerate wound healing; acts as an inhibitor of phospholipase A, which is a key enzyme in inflammatory reactions

ω -conotoxin MVIIA – Extracted from the cone snail *Conus magus*; potent pain-killer; acts by interfering with calcium ion flux, thereby reducing the release of neurotransmitters

A striking feature of this list is that all of the organisms (except the cone snail) are sessile (non-moving) invertebrates. To date, this has been true of most marine invertebrates that produce pharmacologically-active substances. Several reasons have been suggested to explain why sessile marine animals are particularly productive of potent chemicals. One possibility is that they use these chemicals to repel predators, because they are basically "sitting ducks." Another possibility is that since many of these species are filter feeders, and consequently are exposed to all sorts of parasites and pathogens in the water, they may use powerful chemicals to repel parasites or as antibiotics against disease-causing organisms. Competition for space may explain why some of these invertebrates produce anti-cancer agents. If two species are competing for the same piece of bottom space, it would be helpful to produce a substance that would attack rapidly dividing cells of the competing organism. Since cancer cells often divide more rapidly than normal cells, the same substance might have anti-cancer properties.

For more information about drugs from the sea, visit <https://www.ncbi.nlm.nih.gov/pmc/articles/PMC3783861/>

Ocean Health Overview

"The First Global Integrated Marine Assessment" under the United Nations' Regular Process for Global Reporting and Assessment of the State of the Marine Environment, including Socioeconomic Aspects (Inniss et al., 2016) documents multiple stresses that currently affect Earth's ocean. These are summarized below (unless otherwise cited, this information is from the Inniss et al. report).

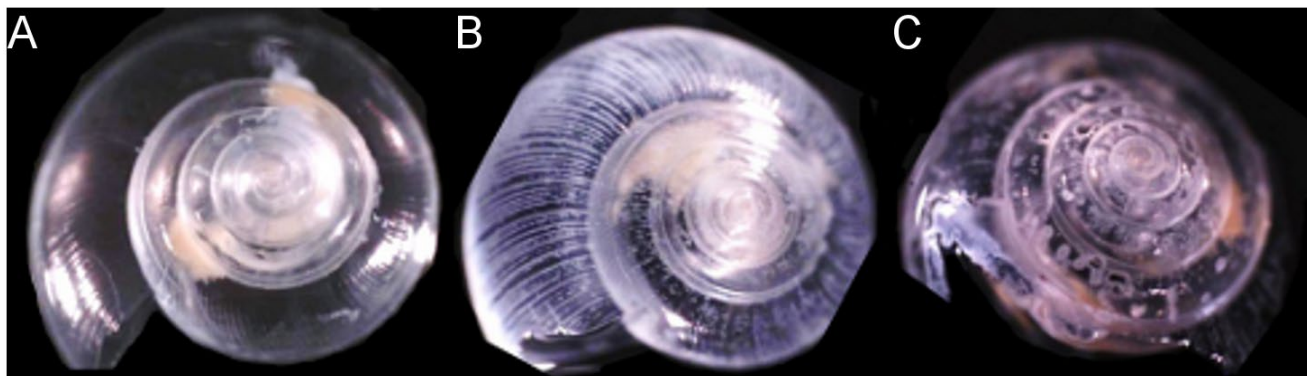

Acidification

Ocean acidification is “the other carbon dioxide problem,” additional to the problem of carbon dioxide as a greenhouse gas. For many years, carbon dioxide in Earth’s atmosphere has been increasing. Regardless of the reasons for this increase and the possible connection with climate change, about 26% of increasing carbon dioxide is absorbed by the ocean where it reacts with seawater to form carbonic acid resulting in a lower ocean pH. This, in turn, leads to a decrease in carbonate ions that are essential to the process of calcification through which many organisms produce shells and other skeletal structures. Corals, shellfish, echinoderms, and many marine plankton build body parts through calcification. Pteropods are planktonic snails that are an important component of food chains in high-latitude regions, and have been shown to have pitted or partially dissolved shells in waters where carbonate ions are depleted.

See Appendix I (pg 46) for more information about pH, the carbonate buffer system, and a demonstration of ocean acidification.

Changes in Sea Temperature and Salinity

Earth is absorbing more heat than it is emitting back into space, and nearly all that excess heat is being stored in the ocean. During the last thirty years, approximately 70 per cent of the world’s coastline has experienced significant increases in sea-surface temperature. Global sea surface temperature is approximately one degree C higher now than 140 years ago. One degree may not sound like much, but the key point is the rate at which this increase has taken place. Over the past 25 years the rate of increase in sea surface temperature in all European seas has been about 10 times faster than the average rate of increase during the past century. Earth’s ocean could warm by an additional one to two degrees C by the end of this century.

Many marine organisms live at temperatures close to their thermal tolerances, so even a slight warming could have serious effects on their physiological functioning and ability to survive. Coral reefs are a frequently-cited example. Shallow-water reef-building corals live primarily in tropical latitudes (less than 30 degrees north or south of the equator) where water temperatures

Representative shells from pteropods incubated in seawater containing three different concentrations of dissolved carbon dioxide; lowest dissolved carbon dioxide concentration is on the left, largest dissolved carbon dioxide concentration is on the right. Note corrosion on the ribs of the shell in image (b) and the shell perforations in image (c). Tissue that was not dissolved during the sodium hypochlorite incubation is visible as yellow-white material inside of the shells. <https://doi.org/10.1371/journal.pone.0105884.g007>



During the Submarine Ring of Fire 2014 Expedition, two of the vent sites visited, NW Eifuku and NW Rota-1, were known to have extremely high concentrations of carbon dioxide (CO₂), with liquid CO₂ and CO₂ bubbles streaming from them. This high concentration of CO₂ leads to local acidification at much more extreme levels than expected as a result of global climate change. NW Eifuku hosts dense beds of mussels (*Bathymodiolus brevior*) whose shells are eroded and thin due to the acidity. Samples of these mussels were collected to determine whether the high-CO₂ habitats cause marked physiological stress or whether these mussels are thriving in spite of their thin shells. Image courtesy of NOAA/PMEL, NSF, Submarine Ring of Fire 2014 - Ironman. <http://oceanexplorer.noaa.gov/explorations/14fire/background/macrobio/media/mussels.html>

The 3rd Global Coral Bleaching Event

In 1998, a huge underwater heatwave killed 16% of the corals on reefs around the world. Triggered by the El Niño of that year, it was declared the first major global coral bleaching event. The second global bleaching event that struck was triggered by the El Niño of 2010. NOAA announced the third global bleaching event in October 2015 and it has become the longest and most widespread event in recorded history.

The new phenomenon of global coral bleaching events is caused by ocean warming (93% of climate change heat is absorbed by the ocean). Corals are unable to cope with today's prolonged peaks in temperatures. Although reefs represent less than 0.1 percent of the world's ocean floor, they help support approximately 25 percent of all marine species. As a result, the livelihoods of 500 million people and income worth over \$30 billion are at stake.

The two previous events caught society relatively unprepared. The world simply didn't have the technology, understanding or teams in place to reveal and record them properly. 2015 was different—sponsored by an insurance company interested in the risk resulting from ocean warming, the XL Catlin Seaview Survey, running off predictions issued by NOAA's Coral Reef Watch programme (which have proven to be accurate), was able to respond quickly. A major global bleaching event is considered one of the most visual indicators of climate change.

www.globalcoralbleaching.org/#overview

are close to the maximum temperature that corals can tolerate. Abnormally high temperatures result in thermal stress, and many corals respond by expelling symbiotic algae (zooxanthellae) that live within the coral's soft tissues. Since the zooxanthellae are responsible for most of the corals' color, corals that have expelled their algal symbionts appear to be bleached. Zooxanthellae are important to corals' nutrition and growth, and expelling these symbionts can have significant impacts on the corals' health. In some cases, corals are able to survive a bleaching event and eventually recover; but if other types of stress are present and the stress is sustained, the corals may die.

Even when individual species are able to tolerate increased temperatures, they may still be affected by changes within their food webs. For example, warmer waters in northwestern Europe have caused clams (*Macoma balthica*) to spawn earlier in the year, but blooms of phytoplankton on which the clams feed do not happen until later in the spring. Clam larvae also face increased predation from shrimp whose abundance has increased in early spring due to warmer temperatures.

Changes in rainfall along with melting glaciers and ice-caps have resulted in changes in patterns of ocean salinity. Observations suggest that surface salinity in subtropical ocean regions and the entire Atlantic basin has increased, while low-salinity regions, such as the western Pacific Warm Pool, and high-latitude regions have become even less saline. Salinity variations are one of the drivers of ocean currents, so salinity changes can affect seawater circulation, as well as directly changing the chemical environment of ocean plants and animals.

Differences in salinity and temperature among different bodies of seawater result in stratification, in which seawater forms layers, with limited exchange of oxygen and other dissolved chemicals between the layers. Increased stratification has been noted around the world, particularly in the North Pacific and,



more generally, north of 40°S. The resulting decreased mixing reduces oxygen content and the extent to which the ocean is able to absorb heat and carbon dioxide, because less water from the lower layers is brought up to the surface where absorption of heat and carbon dioxide takes place. Reduced vertical mixing also limits the amount of nutrients brought up from lower levels into the zone where photosynthesis takes place, and consequently reduces overall ecosystem productivity.

Melting polar sea ice associated with increased sea surface temperatures means that there are increasing opportunities for shipping between the Atlantic and Pacific Oceans via polar routes (which are shorter and therefore economically advantageous compared to more southerly routes). Increased shipping traffic in polar regions means increased risk of marine pollution, as well as increased risk of introducing non-native invasive species. Polar ecosystems generally have low rates of recovery, so pollution damage could be particularly serious.

Increased Mortality of Animal Populations

Global demand for seafood has grown steadily over the past century, resulting in increasingly sophisticated fishing industries that use powerful boats, freezer trawlers, acoustic fish finders, and other advanced technologies. The global harvest from capture fisheries is on the order of 80 million tons, which is near the upper limit of the ocean's productive capacity. Of the fish stocks that are scientifically monitored, about one-fourth are overfished, and more are still recovering from previous overfishing. The impacts of overfishing extend beyond the individual target species. Marine mammals, reptiles, sea birds, and other fish species are all vulnerable to increased mortality as "by-catch" to commercial fisheries. If all fisheries were effectively managed, the overall yield could increase by as much as 20 percent.

Reproductive success in many species is being reduced by multiple pressures from human activity, including invasive species (rats and other predators at sea bird breeding sites), coastal development at historical breeding and nursery sites, and impacts from hazardous substances.

Physical Alteration of Sea-Bed Habitats

Benthic communities are particularly vulnerable to negative impacts from bottom-contacting fishing gear, and damage to coastal and shelf benthic habitats has been documented everywhere such gear is used. Deepwater coral and sponge communities that have been damaged by bottom trawling are expected to require at least a century to recover. Changes to physical and chemical habitat conditions including temperature, salinity, dissolved oxygen, nutrient levels, turbidity, pollutants, sedimentation, and sea floor disturbance have all been shown to influence fish-community composition and structure in every ocean basin.



Inputs of Harmful Materials

For thousands of years, Earth's ocean has provided a convenient means for disposing of unwanted products of human activity. The ocean's impressive size, coupled with the fact that it is largely out of sight, makes it easy to assume that this practice is of no particular consequence. But there is growing evidence that thousands of different inputs are having a significant impact. These inputs include:

- **Runoff from agriculture and from urban areas** – Water draining from agricultural areas often contains pesticides and fertilizers that eventually enter the marine environment. Nutrients from fertilizers cause algal blooms that lead to serious depletion of dissolved oxygen and large areas that do not have enough oxygen to support marine life (dead zones). The 2017 dead zone in the Gulf of Mexico, for example, covered 8,776 square miles—an area the size of New Jersey.

Gulf of Mexico dead zone in July 2017
At 8,776 square miles, the 2017 dead zone in the Gulf of Mexico is the largest ever measured. Image courtesy of N. Rabalais, LSU/LUMCON. <http://www.noaa.gov/media-release/gulf-of-mexico-dead-zone-is-largest-ever-measured>

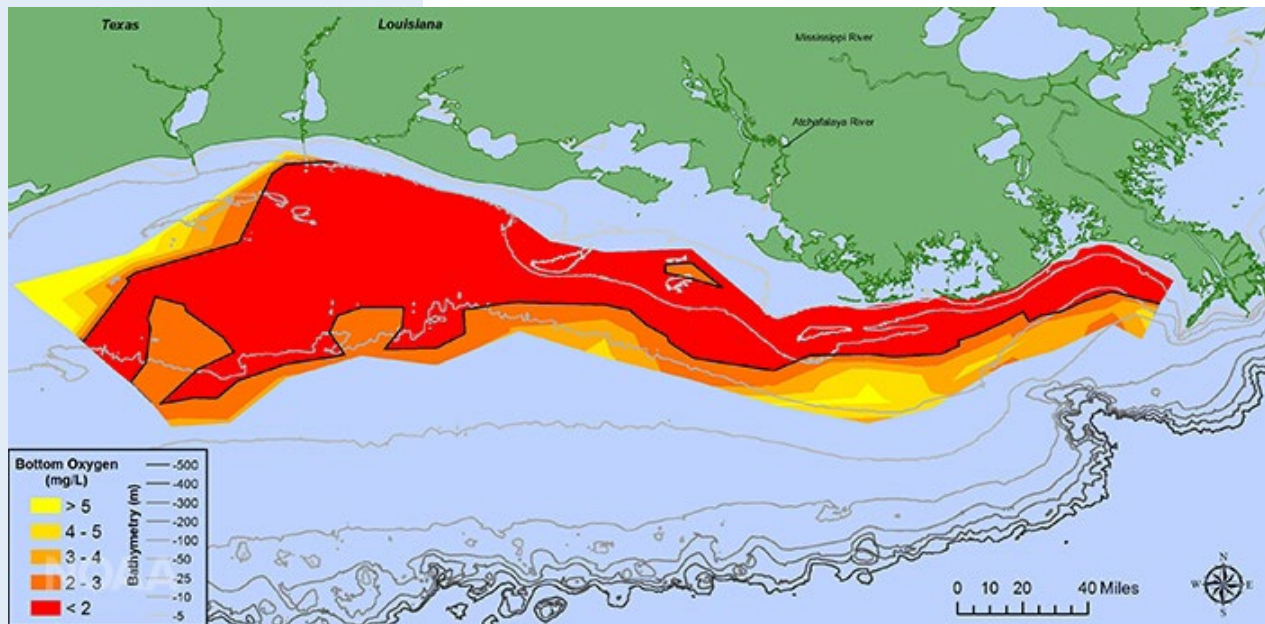

- **Littering and dumping of garbage and waste**—Marine debris is present in all ocean habitats, with an average density of 13,000 to 18,000 pieces per square kilometer. Plastics account for 60% to 80% of all marine debris. Nanoparticles (particles whose dimensions are between 1 and 100 millionths of a millimeter) are a relatively new concern, arising from the breakdown of plastics and from the use of nanoparticles in cosmetics and other industries. Nanoparticles of titanium dioxide are a particular concern because when they are exposed to ultraviolet radiation from the sun they transform into a disinfectant that is known to kill phytoplankton, which are the basis of primary production in the ocean.
- **Sewage discharges** – Human wastes discharged into ocean waters cause human health problems through direct



contact with contaminated water, bacterial contamination of seafood, and by adding nutrients that produce algal blooms that can infect seafood with harmful toxins. These discharges often contain industrial wastes as well, including heavy metals, chlorinated compounds, and organic chemicals (including endocrine disruptors) that are harmful to many organisms including humans.

- **Lost, discarded, and abandoned fishing gear** – Derelict fishing gear (DFG) includes nets, lines, traps, and other recreational or commercial fishing equipment, much of which is made of synthetic materials and metals that last a very long time. DFG may continue to trap and kill fish, crustaceans, marine mammals, sea turtles, and seabirds for years after they are lost.
- **Garbage dumping and discharges from ships** – This was the first source of ocean pollution that was brought under global regulation (by the Convention on the Prevention of Marine Pollution by Dumping of Wastes and Other Matter, 1972), but there is some evidence that oil discharges, sewage pollution, and garbage dumping are still taking place, and some of the world's largest economies have not become party to ocean dumping agreements.
- **Spills from offshore hydrocarbon industries** – Although our economy depends on hydrocarbons, there is a risk of spills, and these industries can also create harmful inputs from contaminated drilling muds, contaminated water, and chemicals used for exploration and production.

Every year, the NOAA Marine Debris Program supports locally driven, community-based marine debris removal projects. These projects benefit coastal habitat, waterways, and wildlife including migratory fish. Image courtesy of NOAA.

<https://marinedebris.noaa.gov/multimedia/photos>

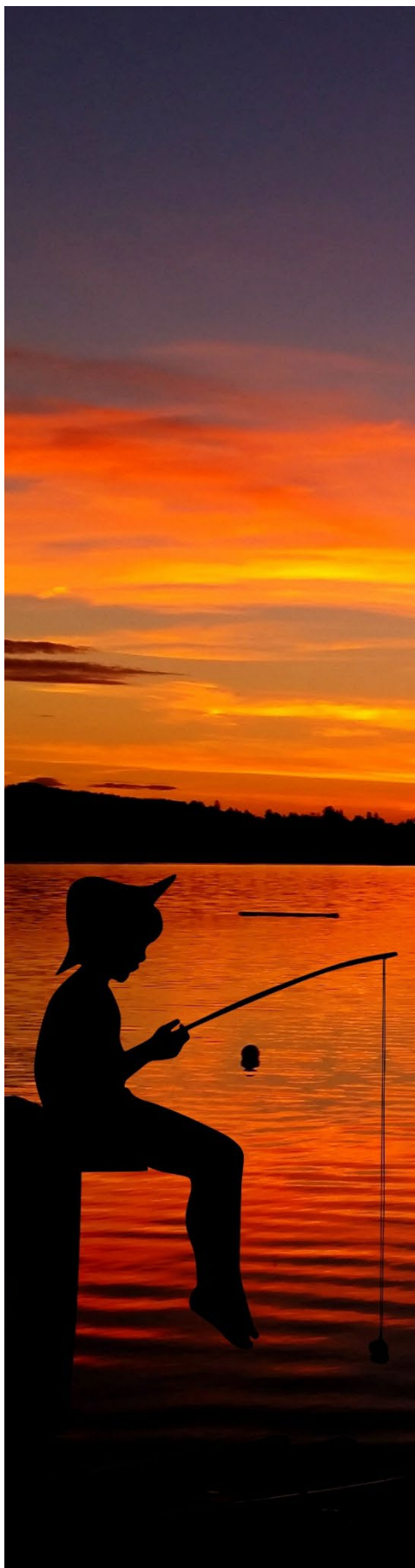

- Habitat destruction, increased turbidity, underwater noise, and other effects from deep sea and offshore mining.

Competing Demands for Marine Space

A large proportion of Earth's human population lives near the ocean; 38% lives within 100 km of the coast; 67% lives within 400 km. Humans want to use ocean resources in many different ways, including recreation, commercial fishing, subsistence fishing, aquaculture, marine ranching, shipping, ports, underwater cables and pipelines, hydrocarbon energy production, mineral mining, wind farms, ocean energy, marine parks and protected areas; and not all of these uses are compatible with each other. Developing effective ways to allocate marine space is a difficult challenge that requires fundamental knowledge about interactions between ocean systems. Providing that knowledge is a key reason for "why do we explore."

Invasive species are non-native species that have been introduced to a region, have established thriving reproductive populations, and are expanding their range. Invasive species often have no natural predators in their new environment, and can successfully compete with and possibly replace native species. Invasive species may compete with native species for habitat and food resources, and may also act as predators to which native species are not adapted. Invasive species are usually introduced accidentally or deliberately by humans.

Reproductive success in many species is being reduced by multiple pressures from human activity, including invasive species (rats and other predators at seabird breeding sites), coastal development at historical breeding and nursery sites, and impacts from hazardous substances.

Where Do We Go From Here?

Ocean Health issues revolve around two points:

- 1) **Earth's ocean is about systems; everything is connected.**
- 2) **Human activities have global impacts on Earth's ocean.**

It's very easy to be overwhelmed by the magnitude of ocean health problems, and just assume we can do nothing. The reality is that these problems did not arise through a single, deliberate action. They are the result of numerous individual actions that took place without any consideration for their collective impacts on Earth's ecosystems. And another reality is that effective solutions to these problems will not occur in a single, global action, but rather will involve numerous individual actions that by themselves seem insignificant, but collectively can have global impacts. Individually, we are all insignificant on a global scale. Collectively, we have global impacts. The root cause of many ocean health problems is the cumulative impact of individual actions; and many solutions to these problems also depend upon the cumulative impact of individual actions.

Appendix I

More About pH

What Do pH Numbers Mean?

An “acid” is commonly defined as a chemical that releases hydrogen ions (abbreviated H^+). The pH (which stands for “power of hydrogen”) of a solution is defined as the negative logarithm of the hydrogen ion concentration in moles per liter. So,

$$pH = -\log [H^+]$$

where brackets are understood to mean “concentration.”

The logarithm of a number x is the power to which another number called the “base” must be raised to produce x . So, the logarithm of 1000 to the base 10 is 3 because 10 raised to the power of 3 is equal to 1000. Where pH is concerned, the base is always 10. If a solution has a hydrogen ion concentration of 1×10^{-7} moles/liter, the logarithm of this concentration is -7, and the pH is 7. The pH scale ranges from 0 to 14, which corresponds to a hydrogen ion concentration range of 1.0 mole/liter to 1×10^{-14} mole/liter. A pH of 7 is considered neutral. A pH below 7 (higher hydrogen ion concentration) is acidic; a pH above 7 (lower hydrogen ion concentration) is basic.

A decrease of 0.1 pH unit may not seem like much, until we remember that this is a logarithm. So a pH of 8.2 corresponds to a hydrogen ion concentration of:

$$1 \times 10^{-8.2} \text{ moles/liter} = 0.00000000631 \text{ moles/liter}$$

(10 raised to the -8.2 power)

and a pH of 8.1 corresponds to a hydrogen ion concentration of:

$$1 \times 10^{-8.1} \text{ moles/liter} = 0.00000000794 \text{ moles/liter}$$

so a drop of 0.1 pH unit represents a 25.8% increase in the concentration of hydrogen ions.

Note that while the term “ocean acidification” is commonly used, the ocean is not expected to actually become acidic (which would mean that the pH was below 7.0). “Acidification” in this case only means that the pH is declining.

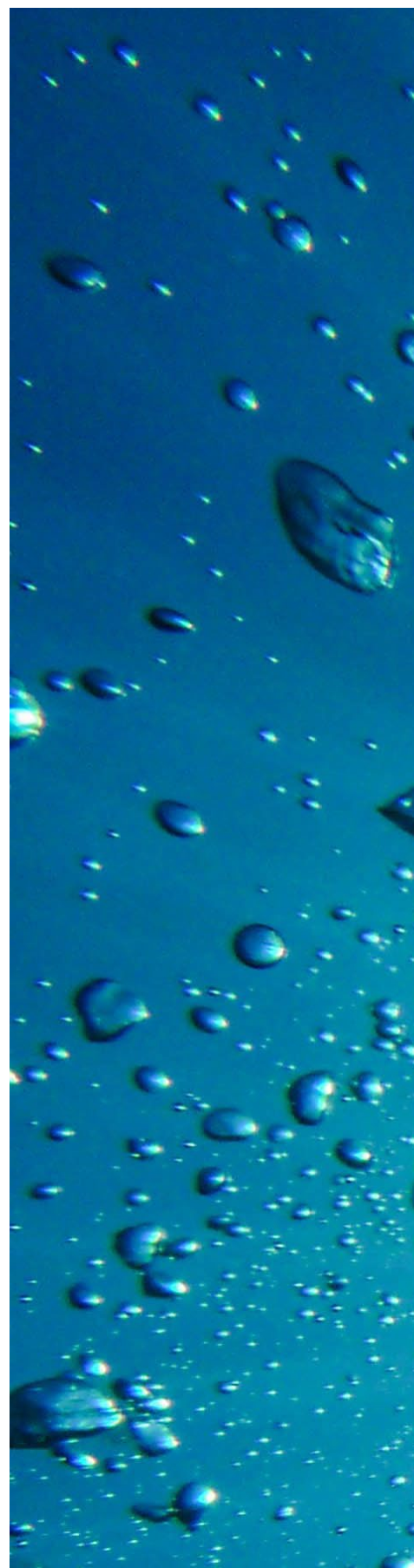

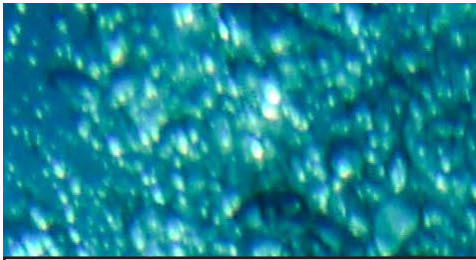

The Carbonate Buffer System

pH is a measure of acidity, which is the concentration of hydrogen ions; increasing hydrogen ions causes increased acidity. A pH of 7 is considered neutral; a pH below 7 is acidic; a pH above 7 is basic. Dissolved chemicals cause seawater to act as a pH buffer; that is, seawater tends to resist changes in pH. This Carbonate Buffer System is described by the following equation:

The Carbonate Buffer System Equation

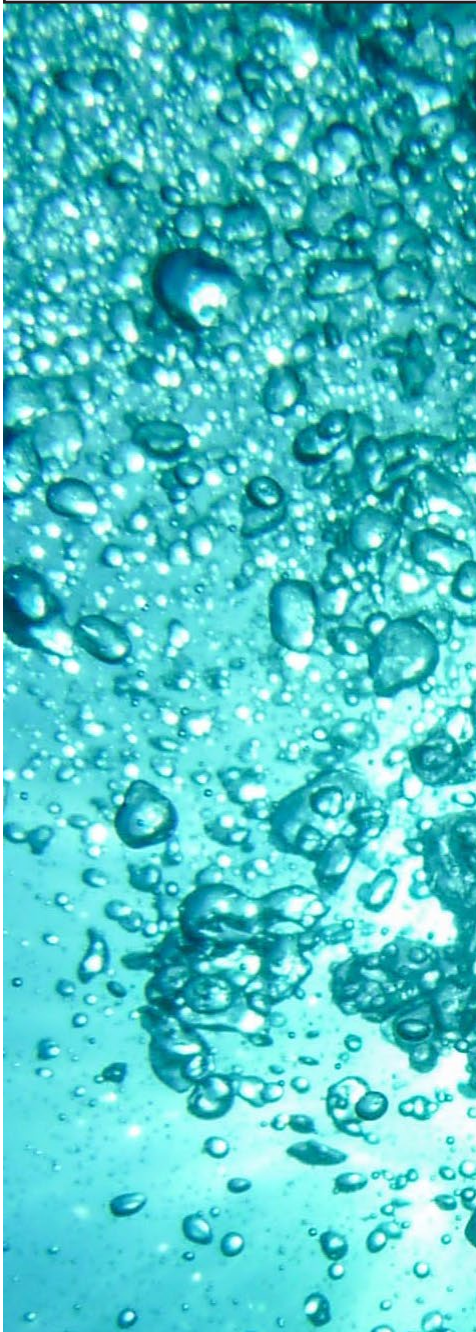
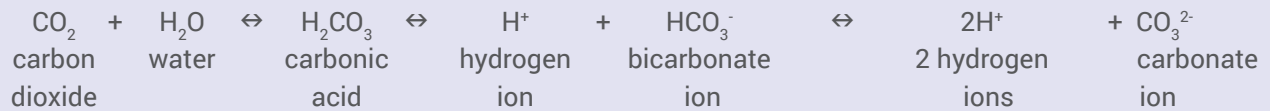

This equation shows that carbon dioxide dissolves in seawater to form carbonic acid, a weak acid. Most of the carbonic acid normally dissociates to form hydrogen ions, bicarbonate ions, and carbonate ions. Carbon dioxide, carbonic acid, bicarbonate ions, and carbonate ions are all present in normal seawater, although not in the same concentrations (about 87% of inorganic carbon is bicarbonate, about 12% is carbonate, and carbonic acid and carbon dioxide combined are about 1%). When these chemicals are in equilibrium, the pH of seawater is about 8.1 – 8.3 (slightly basic). More dissolved carbon dioxide causes an increase in hydrogen ions and a lower ocean pH. But the pH change in seawater is less than if the same amount of carbon dioxide were dissolved in fresh water because the carbonate buffer system in seawater removes some of the added hydrogen ions from solution.

In addition to the reactions described in the carbonate buffer system equation, other reactions also take place between carbon dioxide, carbonic acid, bicarbonate ions, and carbonate ions. One of these other reactions takes place between carbon dioxide, water, and carbonate ions:

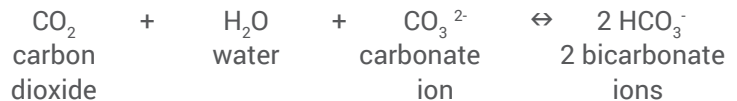

So, adding carbon dioxide to the ocean system can also cause a decrease in carbonate ions; and carbonate ions are essential to the process of calcification through which many organisms produce shells and other skeletal structures.

Demonstrating the Effect of Dissolved Carbon Dioxide on pH

Increased atmospheric carbon dioxide has a demonstrable effect on ocean pH. A simple demonstration of the impact of dissolved carbon dioxide on pH can be found below. While there is some disagreement about the connection between climatic temperature increase and carbon dioxide from human activity, the increase in atmospheric CO₂ and decline in ocean pH are not theoretical; these changes have been confirmed by actual measurements. The following demonstration illustrates this concept.

Educators are urged to try the following procedures in advance of demonstrating before an audience. It is possible that enough atmospheric carbon dioxide may dissolve in distilled water to lower the pH so that the solution will turn yellow as soon as the indicator solution is introduced. If this happens, adjust the starting pH to slightly above neutral by adding a small pinch of baking soda to the distilled water before introducing the indicator solution.

Materials

- Drinking straw
- 100 ml of distilled water
- 100 ml of seawater (natural or artificial)
- Glass jar or beaker, about 200 ml capacity
- Bromothymol Blue Indicator Solution, 0.04% aqueous

Procedure

- Step 1. Pour approximately 100 ml of distilled or tap water into a clean, transparent container. Add 15 drops of bromothymol blue indicator solution.
- Step 2. Pour approximately 100 ml of seawater (artificial or natural) into a second clean, transparent container. Add 15 drops of bromothymol blue indicator solution.
- Step 3. Blow steadily through a drinking straw into the water in the first container, and record the time required for the color to change from blue to yellow-green.
- Step 4. Repeat Step 3 with the water in the second container. Note that it is possible to blow through two straws simultaneously, and if this is done there is no need to record elapsed time.
- Step 5. Discuss the following:
 - Blowing through the straw bubbles carbon dioxide through the liquid in the containers.
 - Carbon dioxide dissolves in water to form a weak acid (carbonic acid).
 - Bromothymol blue is blue in basic solutions, and yellow in acidic solutions. The color change happens in the approximate range of pH 6.0-7.6.
 - A buffer is a solution that tends to resist changes in pH. Ask students to apply one or more of these facts to explain the results of the demonstration. Do these results suggest that seawater may act as a buffer?

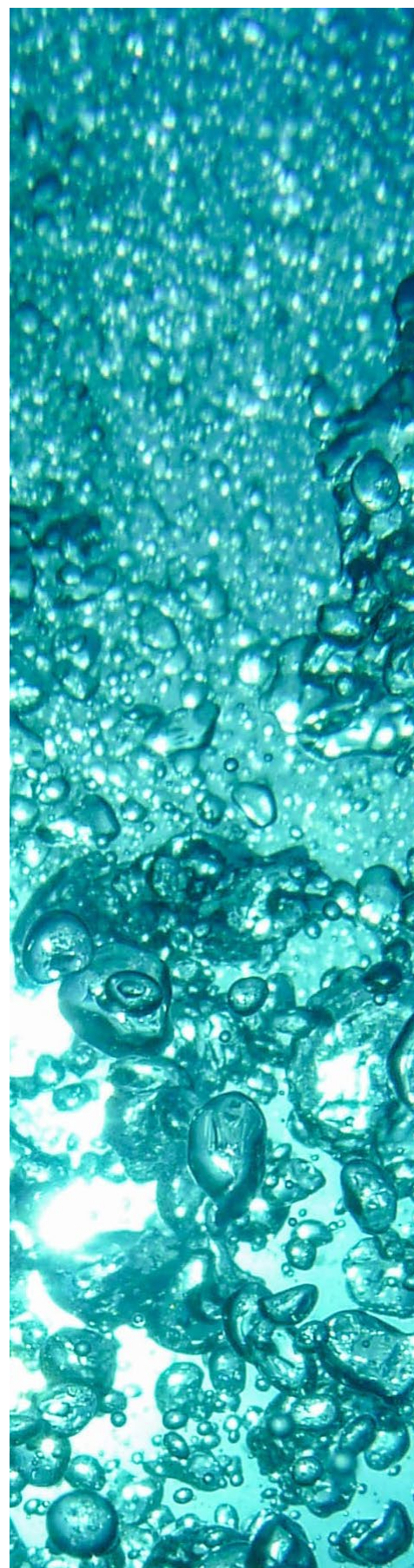



To Boldly Go...

This lesson guides student investigations into reasons for ocean exploration. Other lessons in *Volume I, Why Do We Explore* guide additional investigations into key topics of Ocean Exploration, Energy, Climate Change, Human Health, and Ocean Health.

Focus

Ocean Exploration

Grade Level

Target Grade Level: 6-8; suggested adaptations for grades 5 and 9-12 are provided on page 17.

Focus Question

Why do we explore the ocean?

Learning Objectives

- Students discuss why scientists believe there are important undiscovered features and processes in Earth's ocean.
- Students discuss at least three motives that historically have driven exploration.
- Students explain how ocean exploration helps understand feedback processes that cause changes to Earth systems, including patterns of atmospheric and oceanic circulation and energy flow that affect climate.
- Students discuss how ocean exploration helps develop technological solutions that reduce impacts of human activities on ocean systems.

Materials

- Internet and/or library access for student research
- Stiff paper such as card or cover stock
- Learning Shape patterns (photocopied from page 14, or downloaded from the Internet)
- Scissors
- Markers and/or photo images
- Glue or glue stick

Giant clams (*Tridacna maxima*) symbiotically photosynthesize in the shallow, sun-drenched lagoon of Orona Island, an uninhabited atoll in the Phoenix Islands Protected Area. Image courtesy of Dr. Randi Rotjan/PIPA. <http://oceanexplorer.noaa.gov/oceanos/explorations/ex1703/background/biogeography/media/clams.html>

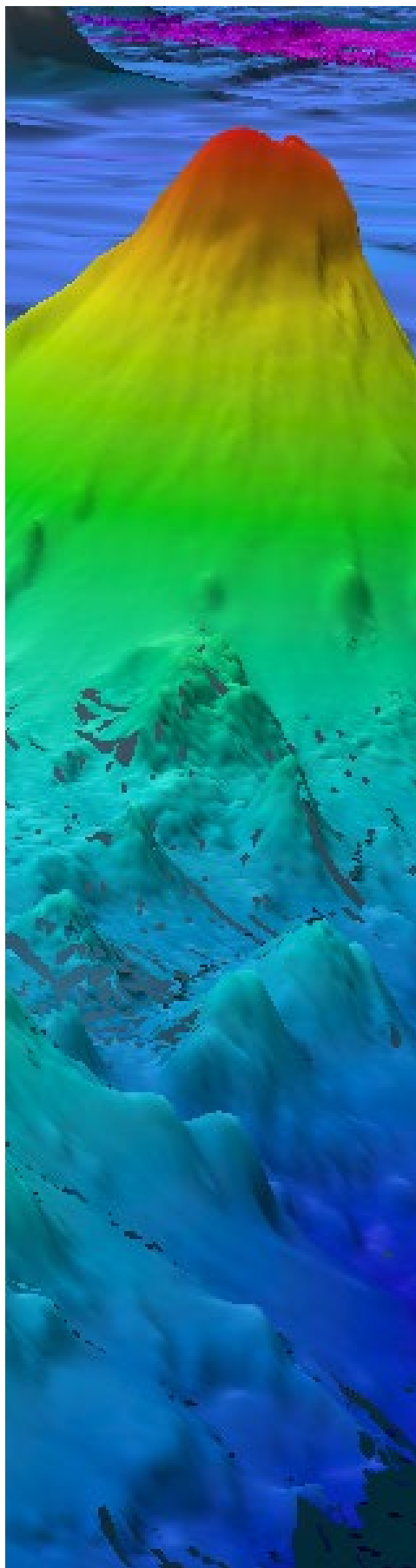

- Two stopwatches or other time interval measuring devices (e.g., stopwatch apps)
- Seaweed crackers, fish crackers or other ocean-themed prizes

Audiovisual Materials

- Multimedia board, marker board, or overhead projector

Key Words and Concepts

Ocean exploration
NOAA Ship *Okeanos Explorer*
Climate change
Deep-sea medicines
pH
Ocean acidification
Telepresence
Methanogenic
Archaea

Background Information

NOTE: Explanations and procedures in this lesson are written at a level appropriate to professional educators. In presenting and discussing this material with students, educators may need to adapt the language and instructional approach to styles that are best suited to specific student groups.

“We know more about the dead seas of Mars than our own ocean.”
~ Jean-Michel Cousteau

Most of Earth’s ocean floor has never been seen by human eyes. While recent satellite maps of Earth’s ocean floor seem to show seafloor features in considerable detail, satellites can’t see below the ocean’s surface. The “images” of these features are estimates based on the height of the ocean’s surface, which varies because the pull of gravity is affected by seafloor features. Moreover, at the scale of a typical wall map (about 1 cm = 300 km) a dot made by a 0.5 mm pencil represents an area of over 60 square miles! Modern ocean exploration begins with high resolution mapping that allows explorers to focus on areas of particular interest and importance. Multibeam sonar mapping systems can produce images that are thousands of times more detailed than satellite imagery. Under ideal conditions, multibeam systems can map features as small as 40 meters wide at 4000 meters depth. However, only about 15% of Earth’s deep ocean has been mapped at a resolution that is adequate for modern exploration.

NOAA Ship *Okeanos Explorer*

On August 13, 2008, the NOAA Ship *Okeanos Explorer* was commissioned as “America’s Ship for Ocean Exploration;” the only federal U.S. ship whose sole assignment is to systematically explore our

Multibeam bathymetry of Pao Pao Seamount. Image courtesy of NOAA OER, Discovering the Deep: Exploring Remote Pacific MPAs 2017.
<http://oceanexplorer.noaa.gov/okeanos/explorations/ex1703/dailyupdates/media/mar9.html>



The NOAA Ship *Okeanos Explorer*, America's ship for ocean exploration. Image courtesy NOAA. <http://oceanexplorer.noaa.gov/okeanos/explorations/ex1702/logs/mar1/media/okeanos.html>

largely unknown ocean for the purposes of discovery and the advancement of knowledge. Similar ships are operated by the Schmidt Ocean Institute (R/V *Falkor*) and the Ocean Exploration Trust (E/V *Nautilus*). Please see the *Introduction to Ships and Their Strategy for Exploration* <http://oceanexplorer.noaa.gov/okeanos/edu/collection/media/hdwe-StrategyBkgnd.pdf> for details.

To fulfill its mission, the *Okeanos Explorer* has specialized capabilities for finding new and unusual features in unexplored parts of Earth's ocean, and for gathering key information that will support more detailed investigations by subsequent expeditions. These capabilities include:

- Underwater mapping using multibeam sonar capable of producing high-resolution maps of the seafloor to depths of 6,000 meters;
- Underwater robots (remotely operated vehicles, or ROVs) that can investigate the water column and seafloor through high definition video and still imaging as well as collect biological and geological samples; and
- Advanced broadband satellite communication and telepresence.

Capability for broadband telecommunications provides the foundation for telepresence: technologies that allow people to observe and participate in activities at remote locations. This allows live video to be transmitted from the seafloor to scientists ashore, classrooms, newsrooms and living rooms, and opens new educational opportunities, which are a major part of *Okeanos Explorer's* mission for advancement of knowledge. In addition, telepresence makes it possible for shorebased members of the science community to share their expertise with shipboard scientists and ROV pilots in real time. This allows more scientists to participate in expeditions at a fraction of the cost of traditional oceanographic expeditions.

***Okeanos Explorer* Vital Statistics:**

Commissioned: August 13, 2008; Seattle, Washington
 Length: 224 feet
 Breadth: 43 feet
 Draft: 15 feet
 Displacement: 2,298.3 metric tons
 Berthing: 49, including crew and mission support
 Operations: Ship crewed by NOAA Commissioned Officer Corps and civilians through NOAA's Office of Marine and Aviation Operations (OMAO); Mission equipment operated by NOAA's Office of Ocean Exploration and Research

For more information, visit <http://oceanexplorer.noaa.gov/okeanos/welcome.html>.

Follow voyages of America's ship for ocean exploration and all other NOAA OER expeditions via the Digital Atlas at https://www.ncddc.noaa.gov/website/google_maps/OE/mapsOE.htm

Modern Reasons for Ocean Exploration

Ocean exploration supports and enhances the work of many individuals and organizations working on America's key science issues, including:

- **Climate Change** – The ocean has a major influence on weather and climate, but we know very little about deep-ocean processes that affect climate.
- **Energy** – Ocean exploration contributes to the discovery of new energy sources, as well as protecting unique and sensitive environments where these resources are found.
- **Human Health** – Expeditions to the unexplored ocean almost always discover species that are new to science, and many animals in deep-sea habitats have been found to be promising sources for powerful new antibiotic, anti-cancer and anti-inflammatory drugs.
- **Ocean Health** – Many ocean ecosystems are threatened by pollution, overexploitation, acidification and rising temperatures. Ocean exploration can improve understanding of these threats and ways to improve ocean health.
- **Research** – Expeditions to the unexplored ocean can help focus research into critical areas that are likely to produce tangible benefits.
- **Innovation** – Exploring Earth's ocean requires new technologies, sensors and tools and the need to work in extremely hostile environments is an ongoing stimulus for innovation.
- **Ocean Literacy** – Ocean exploration can help inspire new generations of youth to seek careers in science, technology, engineering and mathematics and offers vivid examples of how concepts of biology, physical science, and earth science are useful in the real world.



The science and ship crew of the HMS *Challenger* in 1874. The original crew of 216 had dwindled to 144 by the end of the long expedition. Image courtesy NOAA.

Many Reasons to Explore

Historically, explorers have been driven by a variety of motives. For some, the primary reason to explore was to expand their knowledge of the world. For others, economic interests provided powerful incentives, and many expeditions have launched on such missions as finding a sea route to access the spices of Asia, or quests for gold, silver, and precious stones. Political power and the desire to control large empires motivated other explorations, as did the desire to spread religious doctrines. In the case of space exploration, additional reasons have been offered, including understanding our place in the cosmos, gaining knowledge about

the origins of our solar system and about human origins, providing advancements in science and technology, providing opportunities for international collaboration, and keeping pace with other nations involved in developing space technology. The first ocean exploration for the specific purpose of scientific research is often considered to be the voyage of the HMS *Challenger*, conducted between 1872-1876 (visit <http://oceanexplorer.noaa.gov/explorations/03mountains/background/challenger/challenger.html> and <http://www.coexploration.org/hmschallenger/html/AbouttheProject.htm> for more information about the HMS *Challenger* expedition and comparisons with modern oceanographic exploration).

Curiosity, desire for knowledge, and quest for adventure continue to motivate modern explorers. But today, there are additional reasons to explore Earth's ocean, including climate change, energy, human health, ocean health, innovation, research and ocean literacy.

The retreat of Grinnell Glacier from 1938 to 2013. Image from the Repeat Photography Project of the Northern Rocky Mountain Science Center (NOROCK). <https://www.usgs.gov/centers/norock/>



1938 T. J. Hileman photo Courtesy of GNP Archives **1981** Carl Key photo USGS **1998** Dan Fagre photo USGS **2013** Kevin Jacks photo USGS

Oblique view of Grinnell Glacier taken from the summit of Mount Gould, Glacier National Park. The relative sensitivity of glaciers to climate change is illustrated by the dramatic recession of Grinnell Glacier while surrounding vegetation patterns remain stable.

Climate Change

Earth's average temperature is warmer than it has been at any time since at least 1400 AD. While there is ongoing political debate about the causes of climate change, there is a growing body of scientific evidence that shows:

- Mountain glaciers are melting;
- Polar ice is decreasing;
- Springtime snow cover has been reduced;
- Ground temperature has been increasing in many areas; and
- Sea level has risen by several inches in the last 100 years.

Potential impacts of global climate include weakening the deep-ocean thermohaline circulation (THC), which plays an important role in transporting heat, dissolved oxygen and nutrients, accelerating the widespread decline of coral reefs, extinction of species such as the polar bear, and year-round access to sea routes through the Arctic. Ocean exploration can provide some of the essential knowledge about ocean-atmosphere interactions that is needed to understand, predict, and respond to these impacts. For additional discussion about climate change and the THC, please see the Diving Deeper section.

Energy

"Methane trapped in marine sediments as a hydrate represents such an immense carbon reservoir that it must be considered a dominant factor in estimating unconventional energy resources; the role of methane as a 'greenhouse' gas also must be carefully assessed."

from *Gas (Methane) Hydrates—A New Frontier*,
Dr. William Dillon, U.S. Geological Survey;

http://physics.oregonstate.edu/~hetheriw/projects/energy/topics/doc/fuels/fossil/methane_hydrate/methane_hydrate_japan_geo_survey/usgs_hydrate.html

Methane hydrates are ice-like substances formed when molecules of water form an open lattice that surrounds molecules of methane without forming chemical bonds between the two materials. In deep-ocean sediments, conditions of low temperature and high pressure allow methane hydrate deposits to form. There is growing interest in these deposits as an alternative energy source, because the U.S. Geological Survey has estimated that on a global scale, methane hydrates may contain roughly twice the carbon contained in all reserves of coal, oil, and conventional natural gas combined. In addition, methane hydrates are associated with unusual and possibly unique biological communities containing previously-unknown species that may be sources of beneficial pharmaceutical materials. These communities include microorganisms that eat methane (methanotrophs), as well as animals that are able

When ice-rich permafrost thaws, former tundra and forest turns into a thermokarst lake as the ground subsides. The carbon stored in the formerly frozen ground is consumed by the microbial community, who release methane gas. When lake ice forms in the winter, methane gas bubbles are trapped in the ice. Image courtesy Miriam Jones, U.S. Geological Survey.

<https://prd-wret.s3-us-west-2.amazonaws.com/assets/palladium/production/s3fs-public/PA240043.JPG>





An aggregation of methane ice worms inhabiting a white methane hydrate seen in the Gulf of Mexico, 2012. Studies suggest that these worms eat chemoautotrophic bacteria that are living off of chemicals in the hydrate. Image courtesy of NOAA OER.

http://oceanexplorer.noaa.gov/oceanos/explorations/ex1202/logs/dailyupdates/media/apr12_update.html

to feed directly on methanotrophs, and others (such as highly specialized mussels and tubeworms) that keep a population of methanotrophs in their bodies. The latter is a symbiotic relationship in which the mussel or worm gets some carbon from the methanotroph and the methanotroph gets a protected habitat inside the animal. For more information, please see “Methane in the Ocean” by Monica Heintz <http://oceanexplorer.noaa.gov/explorations/10chile/background/methane/methane.html>.

While there have been concerns that the sudden release of methane from methane hydrates might trigger catastrophic climate change or tsunamis caused by underwater landslides, recent research does not suggest that these are likely events (Talling et al., 2014; Ruppel and Kessler, 2017). Released methane, however, may result in increased acidity of ocean waters and reduced levels of dissolved oxygen (Ruppel and Hamilton, 2014).

Besides methane hydrates, regions such as the Gulf of Mexico produce significant quantities of petroleum. Often, the presence of hydrocarbons at the surface of the seafloor is accompanied by cold-seep communities which are biological communities that derive their energy from gases (such as methane and hydrogen sulfide) and oil seeping out of sediments. In addition to locating new sources of hydrocarbon fuels, exploration of these communities frequently reveals species that are new to science and provides information on ecology and biodiversity that is needed to protect these unique and sensitive environments. For additional discussion about energy, methane hydrates and cold-seep communities, please see the Diving Deeper section.

Human Health

Improving human health is another motive for ocean exploration. Almost all drugs derived from natural sources come from terrestrial plants. But recent explorations have found that some marine invertebrates such as sponges, tunicates, ascidians, bryozoans, and octocorals can also produce powerful drug-like substances. Many of these are sessile (non-moving), bottom-

Tectitethya crypta is a large, shallow-water sponge found in the Caribbean. First studied for medical purposes in the 1950s, scientists isolated two chemicals which were used as models for the development of a number of anti-viral and anti-cancer drugs. These include the HIV drug AZT, a breakthrough in AIDS treatment in the late 1980s, anti-viral drugs to treat herpes, and an anti-leukemia drug. Image Credit: Sven Zea (<http://www.spongeguide.org/>) Info credit: <http://ocean.si.edu/ocean-photos/sea-sponge-hiv-medicine>



dwelling animals that do not appear particularly impressive; yet, they produce more antibiotic, anti-cancer, and anti-inflammatory substances than any group of terrestrial organisms. The potential for discovering important new drugs from deep-ocean organisms is even greater when one considers that most of Earth's seafloor is still unexplored, and deep-sea explorations routinely find species that have never been seen before. For additional discussion about drugs from the sea, please see the Diving Deeper section.

Ocean Health

"The First Global Integrated Marine Assessment" under the United Nations' Regular Process for Global Reporting and Assessment of the State of the Marine Environment, including Socioeconomic Aspects (Inniss et al., 2016) documents multiple stresses that currently affect Earth's ocean, including acidification; changes in sea temperature and salinity; competing demands for marine space; increased mortality of animal populations due to excessive fishing; physical alteration of sea-bed habitats; and inputs of explosives, hazardous gases, hydrocarbons, nutrients, plastics, pathogens, and other hazardous substances.

"Life will find a way," according to chaos theorist Ian Malcolm in *Jurassic Park* (Crichton, 1990). But the question is, "Which life?" Deep-sea explorers often find biological organisms thriving in conditions that would be extremely hostile to humans. But this does not mean that species can simply adapt to stresses from falling pH, rising sea levels and temperatures, pollution and overfishing. We urgently need to learn more about ocean ecosystems and how they affect the rest of our planet. This is one of the most important modern reasons for ocean exploration. Without a doubt, human curiosity, the desire to understand our world, and the excitement of discovery are still among the reasons we explore Earth's ocean; but we also explore to survive. For more information about ocean health issues, please see the Diving Deeper section.

Research

It is important to note that expeditions to the unexplored ocean can help focus research into critical geographic and subject areas that are likely to produce tangible benefits. Telepresence technology aboard the *Okeanos Explorer* allows many explorers to participate at a fraction of the cost of traditional expeditions, as well as opportunities for students and the general public to have a first-hand look at the processes of scientific exploration.

Technological Innovation

The challenges of working in the extremely hostile environments of the deep ocean are an ongoing stimulus for technology innovation and development. For example, the hazards and expense of putting humans into deep ocean environments has stimulated the development of robot systems that can allow humans to see these environments with video technology, and



Coral bleaching in the Maldives captured by The Ocean Agency / XL Catlin Seaview Survey / Richard Vevers in May 2016.

<http://www.globalcoralbleaching.org/#latest-imagery-released-23-sept-2016>

Expedition Science Leads Daniel Wagner (foreground) and Jonathan Tree (background) use transit days to take a look at samples collected. Image courtesy of NOAA OER, 2016 Hohonu Moana. <http://oceanexplorer.noaa.gov/oceanos/explorations/ex1603/dailyupdates/media/mar12.html>



obtain information about physical and chemical conditions (such as temperature and pH) with electronic sensors.

Science Education and Ocean Literacy

Ocean exploration can help inspire new generations of youth to seek careers in science, technology, engineering and mathematics, and offers vivid examples of how concepts of biology, physical science, and Earth science are useful in the real world. Similarly, the challenges of exploring the deep ocean can provide the basis for problem-solving instruction in technology and engineering. Ocean exploration also provides an engaging context for improving ocean literacy, understanding how the ocean influences our lives, and how we influence the ocean. An ocean literate citizenry is increasingly vital as we confront issues such as ocean health and climate change.

Note that many of the topics discussed above apply to more than one reason to explore. Methane hydrates, for example, are relevant to climate change as a potential source of a greenhouse gas that could accelerate trends toward warmer temperatures. Similarly, pH changes discussed under ocean health are also linked to climate change since increased dissolved carbon dioxide in the ocean is the result of increased carbon dioxide in the atmosphere that may be partially responsible for observed changes in Earth's climate. The same issues are also relevant to drugs from the sea, since warmer temperatures and changes in ocean circulation patterns are among the stressors that threaten some of the marine organisms that produce pharmacologically-active substances.

The key point is that ocean processes do not operate in isolation; they interact and affect each other in ways that we are just beginning to understand. We separate these topics as individual examples of reasons to explore, and for improved clarity in an introductory discussion; but it is important to realize that



A technician in the control room of the *Okeanos Explorer* controls the remotely operated vehicle cameras. Image courtesy of NOAA OER, Discovering the Deep: Exploring Remote Pacific MPAs. <http://oceanexplorer.noaa.gov/oceanos/explorations/ex1703/logs/mar27/welcome.html#caitlin>

the ocean is an integrated system—individual organisms and processes always interact with many others, and the whole is much more complex than the sum of the parts.

Learning Procedure

This lesson is designed as a student investigation into the question: Why do we explore the ocean? It is possible to make this lesson an individual student assignment, but a group of students will probably produce a more dynamic exchange of ideas. The basic lesson design is as follows: Assign the guidance questions below to groups of three or four students. Then have each group construct ocean exploration learning shapes as part of its investigation, and use these shapes to reinforce concepts resulting from student research. Finally, use oral reports from these groups as the basis for a full class discussion. The primary curriculum topics of the lesson are interactions between Earth systems, and how ocean exploration can help us understand and mitigate human impacts on natural systems. It is targeted to grade levels 6–8, but suggested adaptations for grades 5 and 9–12 are provided following the Learning Procedure section.

1. To prepare for this lesson:

- Review introductory information on the NOAA Ship *Okeanos Explorer* at <http://oceanexplorer.noaa.gov/okeanos/welcome.html> and <http://oceanexplorer.noaa.gov/okeanos/about.html> and the *Introduction to Ships and Their Strategy for Exploration* <http://oceanexplorer.noaa.gov/okeanos/edu/collection/media/hdwe-StrategyBkgnd.pdf>.
- Review video presentations “Hotspots of Biodiversity” by Kasey Cantwell oceanexplorer.noaa.gov/okeanos/explorations/ex1605/dailyupdates/media/video/hotspots/hotspots.html; “Introduction to NOAA Ship *Okeanos Explorer*” by John McDonough <http://ps.connect230.com/coexploration/mcdonoughjune09/f.htm> and “Deep Ocean Exploration: New Discoveries and Implications for Our Warming Planet” by Steve R. Hammond <http://ps.connect230.com/coexploration/StephenHammond/index.htm>
- (Optional) Download some images from sources provided in the sidebar on the right for use during discussions.
- (Optional) Additional information about the history of ocean exploration is available at <http://oceanexplorer.noaa.gov/history/history.html>.

2. Briefly introduce the ships of exploration NOAA Ship *Okeanos Explorer*, E/V *Nautilus*, and R/V *Falkor*; (see *Introduction to the Ships and Their Exploration Strategy* <http://oceanexplorer.noaa.gov/okeanos/edu/collection/media/hdwe-StrategyBkgnd.pdf>) and the 2017 Discovering the Deep: Exploring Remote Pacific MPAs Expedition <http://oceanexplorer.noaa.gov/okeanos/explorations/ex1703/background/plan/welcome.html>.

Image and Video Resources

Below are links to a selection of images and videos from recent expeditions that can be used to ignite interest in and spark curiosity about deep-sea exploration.

Pharmacology:

Submarine Ring of Fire 2012: NE Lau Basin
<http://oceanexplorer.noaa.gov/explorations/12fire/background/pharmacology/pharmacology.html>

Cold seeps, deep corals, seamounts:

Northeast U.S. Canyons Expedition 2013
<https://oceanexplorer.noaa.gov/okeanos/explorations/ex1304/logs/photolog/welcome.html>

Canyons, seamounts, deep-sea communities:

Our Deepwater Backyard: Exploring Atlantic Canyons and Seamounts 2014
<http://oceanexplorer.noaa.gov/okeanos/explorations/ex1404/logs/photolog/welcome.html>

Deepwater communities in the Gulf of Mexico:

Exploration of the Gulf of Mexico 2014
<http://oceanexplorer.noaa.gov/okeanos/explorations/ex1402/logs/photolog/welcome.html>

Mapping, deepwater corals off Hawai'i:

2015 Hohonu Moana: Exploring Deep Waters off Hawai'i
<http://oceanexplorer.noaa.gov/okeanos/explorations/ex1504/logs/photolog/welcome.html>

Bioluminescence:

Bioluminescence and Vision 2015
<http://oceanexplorer.noaa.gov/explorations/15biolum/logs/photolog/photolog.html>

Hydrothermal vents, deep-sea corals:

2016 Deepwater Exploration of the Marianas
<http://oceanexplorer.noaa.gov/okeanos/explorations/ex1605/logs/photolog/welcome.html>

Deep-sea biodiversity, mapping, telepresence:

2017 American Samoa Expedition:
<http://oceanexplorer.noaa.gov/okeanos/explorations/ex1702/logs/photolog/welcome.html>

Color correcting in the dark abyss:

Discovering the Deep: Exploring Remote Pacific MPAs 2017
<http://oceanexplorer.noaa.gov/okeanos/explorations/ex1703/logs/mar14/welcome.html>

Color in Deep-sea Octocorals:

Exploring the Central Pacific Basin 2017
<http://oceanexplorer.noaa.gov/okeanos/explorations/ex1705/logs/may16/welcome.html>

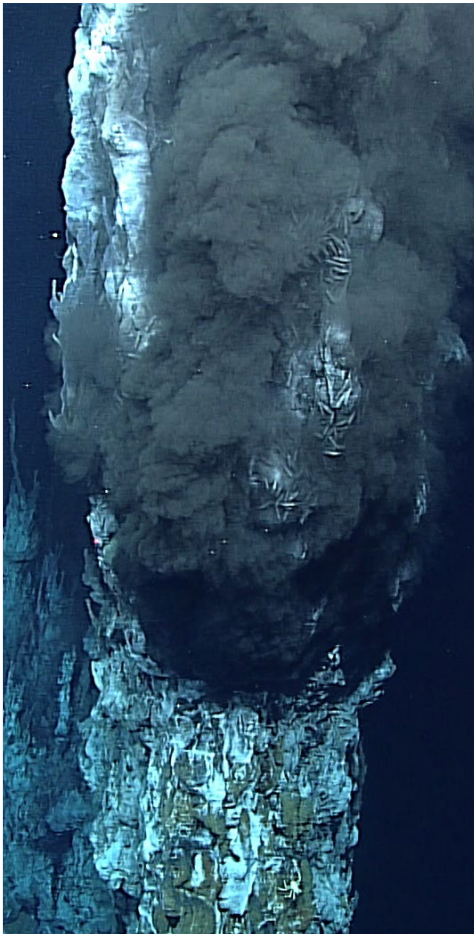

A "black smoker". Where the super-hot vent fluid meets very cold ambient sea water (2°C) of the deep sea, minerals that are carried in the fluid precipitate out of solution, forming spectacular vent chimneys. Here, the temperature of the vent fluid measured 339°C. Image courtesy of NOAA OER, 2016 Deepwater Exploration of the Marianas.
<http://oceanexplorer.noaa.gov/oceanos/explorations/ex1605/logs/may11/media/1605vent.html>



Close-up view of one of the undescribed species of Lamellibrachia (tube worm) that scientists discovered during a 2007 Gulf of Mexico cruise. Image courtesy of NOAA OER, Expedition to the Deep Slope 2007 and Aquapix. http://oceanexplorer.noaa.gov/explorations/07mexico/logs/june14/media/lam_600.html

Briefly discuss why this kind of exploration is important (see background information starting on page 3). Highlight the overall exploration strategy used by ships of exploration including the following points:

- The overall strategy is to develop baseline information about the biological, geological, and water chemistry features of unexplored areas to provide a foundation for future exploration and research.
- This information includes:
 - High resolution maps of the area being explored, as well as areas that the ship crosses while underway from one location to the next (underway reconnaissance)
 - Exploration of water column chemistry and other features
 - High definition close-up video of biological and geological features in the exploration area (site characterization)
- This strategy relies on four key technologies:
 - Multibeam sonar mapping system and other types of sonar that can detect specific features in the water column and on the seafloor;
 - CTD and other electronic sensors to measure chemical and physical seawater properties;
 - A Remotely Operated Vehicle (ROV) capable of obtaining high-quality imagery and samples in depths as great as 6,000 meters; and
 - Telepresence technologies that allow scientists with many different areas of expertise to observe and interact with exploration activities, though they may be thousands of miles from the ship

You may want to show some or all of the images in the sidebar on page 9 to accompany this review.

3. Tell students that their assignment is to answer the question, "Why do we explore the ocean?" Each student or student group should prepare an oral report that addresses the following guidance questions:

- 1) "We know more about the dead seas of Mars than our own ocean." (Jean-Michel Cousteau). How can this be true? And even if it is, so what? Isn't the deep ocean more or less the same, wherever you go?
- 2) Historically, what are some reasons for human exploration?
- 3) Today, are there any other reasons to explore Earth's ocean?
- 4) If time permits, you may also want to have students address the question, "Who are today's ocean explorers?" and refer them to the Ocean Explorer OceanAGE Careers Web page (<http://oceanexplorer.noaa.gov/edu/oceanage/welcome.html>).

- The following links to Ocean Exploration Web pages provide examples of some benefits that can result from ocean exploration:

Energy:

<http://oceanexplorer.noaa.gov/explorations/17atlantic-margin/welcome.html>

<http://oceanexplorer.noaa.gov/explorations/07mexico/welcome.html>

Human Health:

<http://oceanexplorer.noaa.gov/explorations/03bio/welcome.html>

Ocean Health:

<http://oceanexplorer.noaa.gov/facts/acidification.html>

Climate Change:

<http://oceanexplorer.noaa.gov/explorations/16glacierbay/welcome.html>

<http://oceanexplorer.noaa.gov/explorations/16arctic/welcome.html>

4. Have each group make an oral presentation of their findings. When all groups have reported, facilitate a class discussion of these results. Key points for guidance questions should include:

1) "We know more about the dead seas of Mars than our own ocean." (Jean-Michel Cousteau). How can this be true? And even if it is, so what? Isn't the deep ocean more or less the same, wherever you go?

Key Points: Considering the difficulty of photographing large areas of the ocean floor, as well as the three-dimensional nature of ocean habitats, it is easy to see how we might know more about the surface of Mars. While many people think that the deep ocean is more or less homogenous over large areas, recent discoveries of hydrothermal vents, deep-sea cold seeps, underwater volcanoes, seamounts, and other features

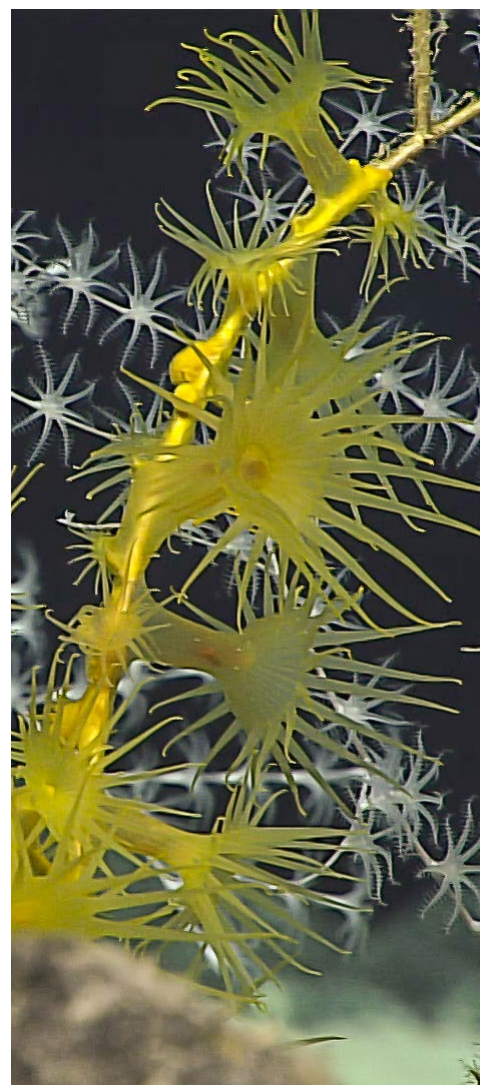
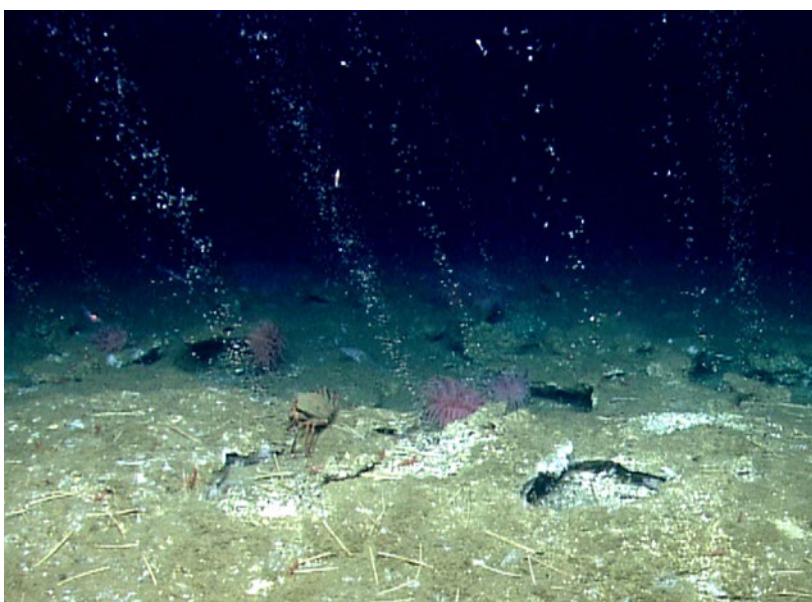

Yellow zoanthids colonize the base of a dead golden octocoral skeleton. Image courtesy of NOAA OER, 2017 American Samoa.

<http://oceanexplorer.noaa.gov/oceanos/explorations/ex1702/dailyupdates/media/feb22.html>

A ~425 meter-deep seep site on the Virginia margin. Authigenic carbonates pave the seafloor in the foreground and at least nine methane bubble streams can be seen in the background. Image courtesy NOAA OER, 2013 Northeast U.S. Canyons Expedition.

<http://oceanexplorer.noaa.gov/explorations/17atlantic-margin/welcome.html>



Operation IceBridge, NASA's aerial survey of polar ice, flies over a lead, or opening in the sea ice cover, near the Alaskan coast on March 11, 2017. Image courtesy NASA/Jeremy Harbeck <https://www.nasa.gov/feature/goddard/2017/sea-ice-extent-sinks-to-record-lows-at-both-poles>



The pteropod, a sea snail as small as the head of a pin, is found in the Pacific Ocean and provides food for salmon, sablefish and rock sole. Because its shell dissolves in waters rich in carbon dioxide, it's been considered an indicator of ocean acidification. Image courtesy of NOAA.

suggest that there is much more variety than was once supposed. Images from “Key Image and Video Resources” (see sidebar on page 9) may enhance discussions.

2) Historically, what are some reasons for human exploration?

Key Points: Students may suggest a considerable variety of motives, including to gain knowledge about the world, obtain economic benefits, increase political power, spread religious doctrines, advance science and technology, and keeping pace with other nations. Simple curiosity and/or the challenge of the unknown are also valid suggestions, though often these are accompanied by more pragmatic considerations as well.

3) Today, are there any other reasons to explore Earth's ocean?

Key Points: Ocean exploration contributes directly to priority issues and needs, including:

- **Climate Change** – The ocean has a major influence on Earth's climate; but we don't even know, let alone understand, all of the processes involved in the interactions between the ocean and climate, because most of the ocean is unknown. You may want to show images that document the decline in polar sea ice and/or glaciers (<https://www.nasa.gov/feature/goddard/2017/sea-ice-extent-sinks-to-record-lows-at-both-poles>; and http://nsidc.org/data/glacier_photo/repeat_photography.html).
- **Energy** – Methane hydrates are an example of potential alternative sources of energy. The U.S. Geological Survey estimates that methane hydrates may contain roughly twice the carbon contained in all reserves of coal, oil, and conventional natural gas combined. Students should also realize that in addition to discovering new energy sources, information from ocean exploration can be used to protect unique and sensitive environments where these resources are found.
- **Human Health** – Animals in deep-sea habitats have been found to be promising sources for powerful new antibiotic, anti-cancer and anti-inflammatory drugs. Expeditions to the unexplored ocean almost always discover species that are new to science, creating a high probability of finding important new natural products.
- **Ocean Health** – Rapid changes in Earth's climate, pollution, and overfishing have serious negative impacts on some ocean ecosystems. Mention the potential impact of rising temperatures on tropical species that are already near their upper thermal tolerance limit, such as corals. Be sure students understand that corals are also subject to a variety of other stresses, and the combined stress from multiple sources amplifies the impacts of climate change.

If it is not mentioned by students, introduce the effect of increased atmospheric carbon dioxide on ocean pH. A simple demonstration of the impact of dissolved carbon dioxide on pH can be found in the Diving Deeper section. Be sure students understand that while there are different opinions about whether increased atmospheric carbon dioxide from human activity is the cause of climatic temperature increase, ocean acidification is not a matter of opinion: the increase in atmospheric CO₂ and decline in ocean pH have been confirmed by actual measurements and are in no way theoretical.

- **Research** – Expeditions to the unexplored ocean can help focus research into critical geographic and subject areas that are likely to produce tangible benefits. Telepresence technology aboard the *Okeanos Explorer* allows many scientists to participate at a fraction of the cost of traditional expeditions, as well as opportunities for students and the general public to have a first-hand look at the processes of scientific exploration.
- **Technological Innovation** – The challenges of working in the extremely hostile environments of the deep ocean are an ongoing stimulus for technology innovation and development.
- **Science Education and Ocean Literacy** – Ocean exploration can help inspire new generations of youth to seek careers in science, technology, engineering, and mathematics, and offers vivid examples of how concepts of biology, physical science, and Earth science are useful in the real world. Similarly, the challenges of exploring the deep ocean can provide the basis for problem-solving instruction in technology and engineering. Ocean exploration also provides an engaging context for improving ocean literacy, understanding how the ocean influences our lives, and how we influence the ocean. An ocean literate citizenry is increasingly vital as we confront issues such as ocean health and climate change.

5. **Ocean Exploration Learning Shapes and the Ocean Exploration Bowl Game** – Learning Shapes are geometric solids constructed by students to provide three-dimensional surfaces for displaying concepts, images, and other information. Many curricula require students to communicate ideas to other groups, and Learning Shapes provide a novel tool that can enhance communication activities. Learning Shapes can be constructed in many sizes, shapes, and colors using a variety of materials (stiff paper such as card stock is inexpensive, versatile, and widely available). In addition to their use as a learning and communication tool, constructing Learning Shapes also provides a basis for potential cross-curricular

Figure 1: Simple Learning Shapes

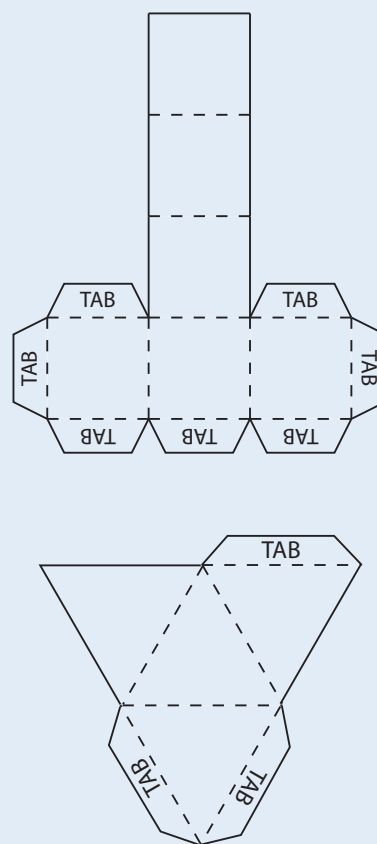

Learning Shapes are fun to make! Image courtesy Mel Goodwin.

Figure 2:
Ocean Exploration Learning Shape Octahedron
Using photocopies fold on dotted lines, and glue tabs under matching edges.

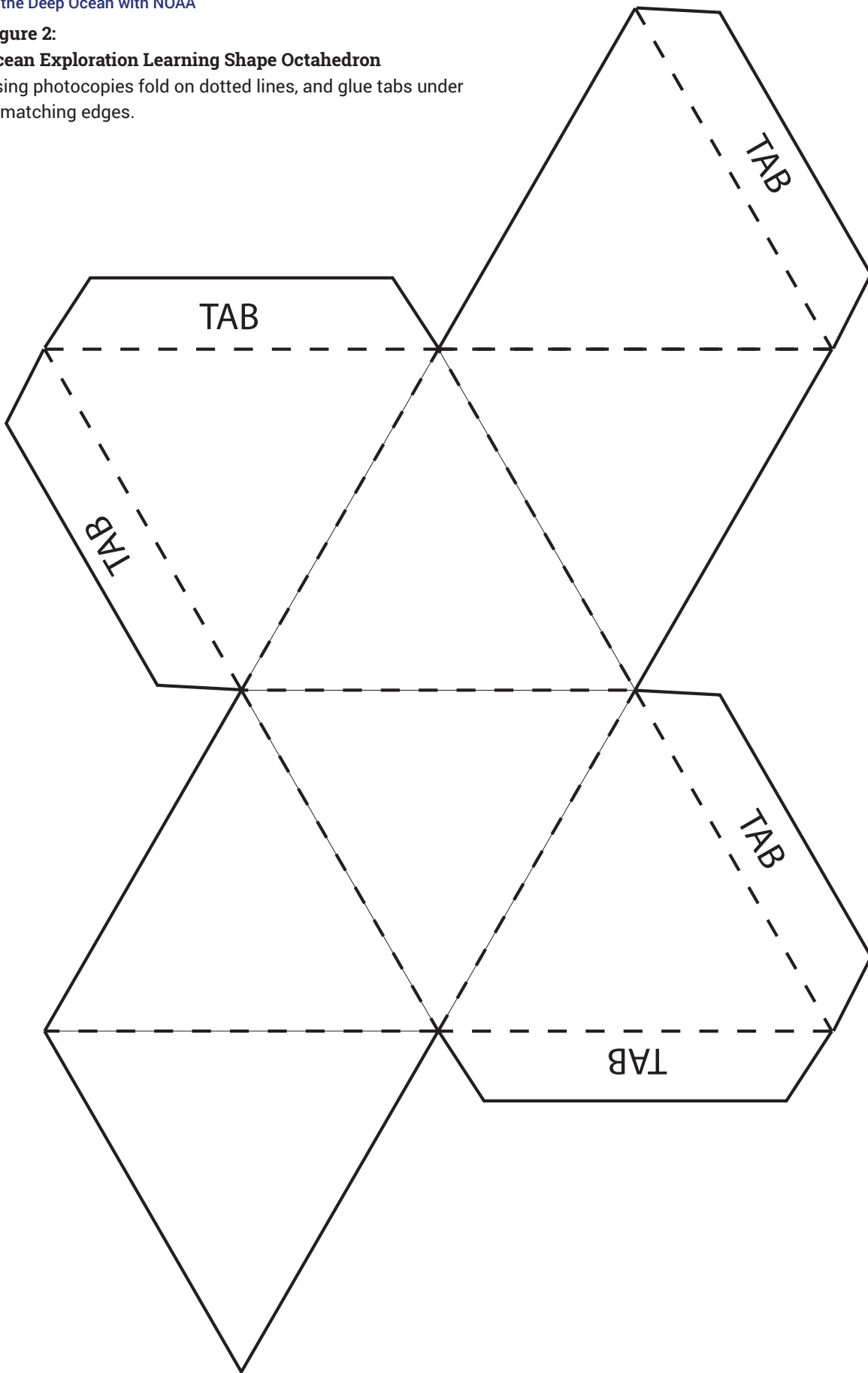

activities with Language Arts and Mathematics, and helps develop engineering skills including layout and design, material selection, modeling, and prototyping. The simplest Learning Shapes are tetrahedrons and cubes, which provide four and six surfaces, respectively, and can be constructed as illustrated in Figure 1. There are numerous books and Web sites that describe how to construct various polygons.

To reinforce concepts resulting from student investigations, students construct Learning Shapes to summarize modern reasons for ocean exploration (*i.e.*, climate change, energy, human health, ocean health, research, technological innovation and ocean literacy), and will use their creations to play a competitive “Ocean Exploration Bowl” game.

- a. Each student group should construct five octahedrons using the pattern illustrated in Figure 2 (page 14). If larger Learning Shapes are desired, the pattern can be copied onto tabloid-size paper or cover stock with an enlarging photocopier.
- b. Students should attach images or text to the eight faces of the Learning Shapes as follows:
 - One Learning Shape should have images attached to seven faces that illustrate the seven modern reasons for ocean exploration discussed above. So one face will have an image representing climate change, another face will have an image that represents energy, and so on. The remaining face should have an image of the NOAA Ship *Okeanos Explorer*. Since this eighth face is used as a neutral image, it could be completely blank, but using an image of America’s Ship for Ocean Exploration makes the Learning Shape much more interesting!
 - One of the Learning Shapes should have text on seven faces that provide a descriptive title for one of the modern reasons for ocean exploration. So there should be one face that says “Energy,” another that says “Ocean Health,” and so on. The eighth face should have an image of the *Okeanos Explorer*, or other neutral image.



NOAA Ship *Okeanos Explorer* <http://oceanexplorer.noaa.gov/okeanos/explorations/ex1702/logs/mar1/media/okeanos.html>



Champagne vent, NW Eifuku seamount in the Marianas region. Image courtesy of Submarine Ring of Fire 2006 Expedition, NOAA OER/PMEL. <http://oceanexplorer.noaa.gov/okeanos/explorations/ex1605/background/history/media/vent.html>

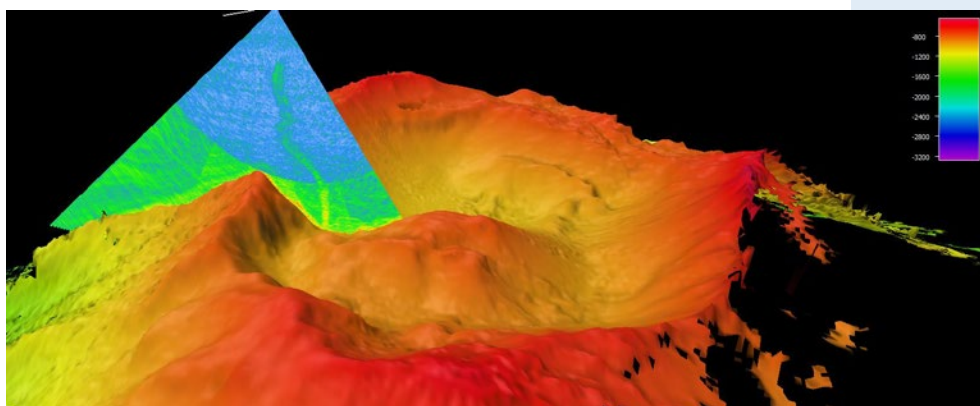

Multibeam sonar imagery shows a plume of bubbles rising from the seafloor at Vailulu'u Seamount near American Samoa. Image courtesy of NOAA OER, 2017 American Samoa Expedition. <http://oceanexplorer.noaa.gov/okeanos/explorations/ex1702/logs/feb22/media/vailulu2.html>



- The three remaining Learning Shapes should also have one neutral face containing an image of the *Okeanos Explorer*. The other seven faces should contain brief text describing a single fact about one of the seven modern reasons for ocean exploration, with a different reason each of the seven faces. So one of the shapes might have a face that says “Methane hydrates are a potential energy source found in the deep ocean” (representing energy as a reason for exploration), another face that says “Deep-sea animals can be promising sources of new drugs” (representing human health as a reason for exploration), and so on.

Note: It is easier to attach images and text before Learning Shapes are fully assembled. Cut out and pre-fold the Shapes, but attach images and/or text before gluing the tabs into place. For sample Learning Shapes, see To Boldly Go Addendum http://oceanexplorer.noaa.gov/okeanos/edu/collection/media/toboldlygo_addendum.pdf

When all five Learning Shapes are completed, it should be possible to orient the shapes so that the upper face of one shape shows a picture representing one of the modern reasons for ocean exploration, the upper face of another shape shows a descriptive title stating the reason in words, and the upper faces of the remaining two shapes show facts relevant to that reason. It should also be possible to orient the four shapes so that the upper face shows a “neutral” image that is not specifically related to a specific reason to explore the ocean.

c. Now it’s time to play “Ocean Exploration Bowl!” The object of this game is for student groups to correctly associate, in the shortest possible time, descriptive titles and relevant facts with an image representing a reason for exploration. Groups compete one at a time, and when all groups have competed, one round has been completed. When a group has finished, ask members of other groups to verify that the selected title and facts correctly match the image. Students have to pay attention to make this verification, and because play proceeds rapidly from group to group, there is minimal down time during which students may become distracted.

Assign two students to act as timekeepers. Since groups compete one at a time, timekeepers can be members of other competing groups. Provide each timekeeper with a stopwatch (or stopwatch app). Have one group arrange their five Learning Shapes on a desk or table so that the image of *Okeanos Explorer* (or other neutral image) shows on the upper face of each Learning Shape.

You (the educator) should pick up the Learning Shape that has images attached, hold it out of students' sight, and orient the Learning Shape so that one of the images representing a reason for ocean exploration is facing the palm of your hand. Put the Learning Shape back onto the table, and say "Boldly Go!" as you remove your hand. The timekeepers should start their stopwatches as soon as you say "Boldly Go!", and students in the group should orient the remaining four shapes as quickly as possible so that the appropriate descriptive title and two relevant facts are facing upward. As soon as they have done this, the group should say "Discovery!" which is the signal for the timekeepers to stop their stopwatches. Have group members state their reason for ocean exploration, and the relevant facts. Record the average time from the two rounds on a score sheet for the competing group. If the educator considers the group's response inadequate, no score is recorded.

Repeat this process for the remaining groups. At least three rounds should be completed to cover all seven reasons and a good selection of relevant facts. When the winning group has been determined (by the shortest average time over all rounds), award prizes such as small bags of seaweed crackers, goldfish crackers, or other ocean-related items. Be sure every group receives something, but it's fine if the winner's share is larger!

If time is short, you may want to have groups construct only the first Learning Shape with images, then have group members state as many relevant facts as possible when a particular image is turned face up. This eliminates the need for timekeepers, but you should probably have several rounds since student research is likely to yield more facts for some reasons than others.

Adaptations for Other Grade Levels

Considerations for Grade 5 – Some students may not be familiar with hydrothermal vents, deep-sea cold seeps, underwater volcanoes, and seamounts that have been relatively recently discovered, so be sure to have images of these habitats available to show after receiving students' comments on the Cousteau quotation. Similarly, students may not be aware of the potential for new medicines or alternative energy sources from deep-sea ecosystems. Depending upon their existing knowledge, you may want to focus primarily upon these potentials as contemporary reasons for ocean exploration, since the relationship between deep-ocean processes and climate change may be difficult to understand at this grade level. In addition, students may be intrigued by how little is known about the deep ocean, and may feel that this is sufficient justification for exploration. Be sure students understand that the *Okeanos Explorer* is the first federal U.S.

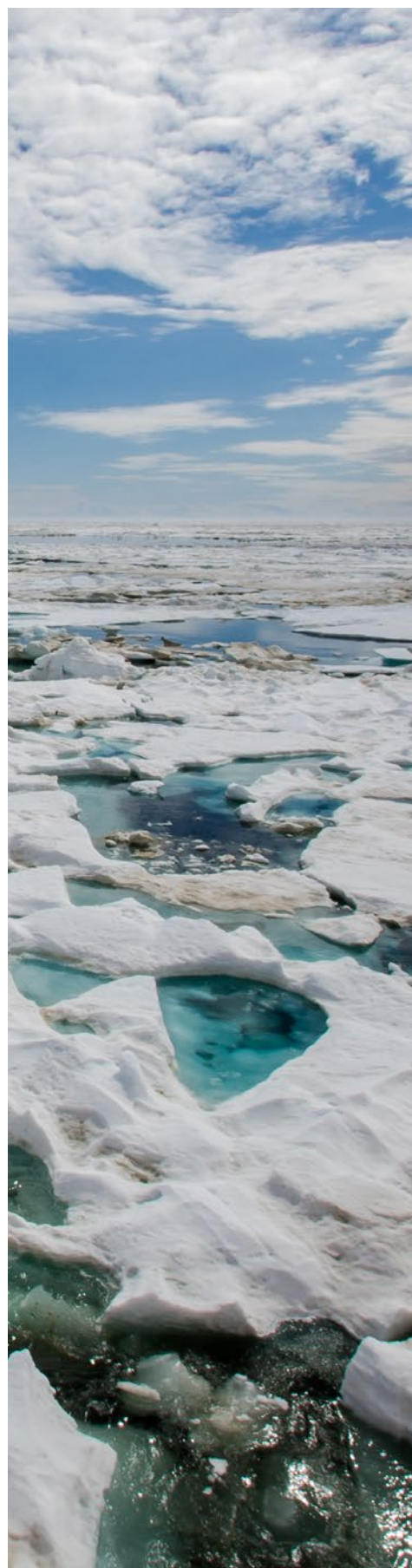



ship to be dedicated specifically to exploring the largely unknown ocean.

Considerations for Grades 9-12 – Ocean acidification, pH, buffers, carbon dioxide sources and sinks, methane hydrates, deep-sea medicines, and deep-ocean habitats (hydrothermal vents, deep-sea cold seeps, underwater volcanoes, and seamounts) can all be explored in greater detail. Consider assigning these topics to individual student groups prior to beginning a discussion focused on ocean exploration. When groups have completed their reports, lead a discussion to address the Guidance Questions and invite groups to present relevant information from their reports in the context of “why explore.”

The BRIDGE Connection

www.vims.edu/bridge/ – In the navigation menu on the left side of the Web page, click “Ocean Science Topics,” then “Human Activities,” then “Technology” for links to information and activities involved with ocean exploration, including satellites, underwater robots, and deep-sea medicines.

The “Me” Connection

Have students write a brief essay about what ocean life might be like in the second half of the 21st century, and how ocean exploration might affect that future.

Connections to Other Subjects

English/Language Arts, Mathematics, Social Studies

Assessment

Written reports may be required as part of Learning Procedure Step 3. These reports, discussions and/or the Ocean Exploration Bowl game provide a basis for assessment.

Multimedia Discovery Missions

<http://www.oceanexplorer.noaa.gov/edu/learning/welcome.html>
Click on the links to Lessons 3, 5, 11, and 14 for interactive multimedia presentations and Learning Activities on Deep-Sea Corals, Chemosynthesis and Hydrothermal Vent Life, Energy from the Oceans, and Seamounts.

Lessons from the NOAA Ship *Okeanos Explorer* Education Materials Collection, Volume 1: Why Do We Explore?

These lessons are accessible online at <http://oceanexplorer.noaa.gov/okeanos/edu/collection/wdwe.html>.

Other Resources

- Archer, D. 2007. Methane hydrate stability and anthropogenic climate change. *Biogeosciences* 4:521–544, 2007
- Boulton, A., L. Allison, and T. Lenton. 2014. Early warning signals of Atlantic Meridional Overturning Circulation collapse in a fully coupled climate model. *Nature Communications* 5, Article number: 5752Brand, U., N., Blarney, C, Garbelli,

E. Griesshaber, R. Posenato, L. Angiolini, K. Azmy, E. Farabegoli, and R. Came. 2016. Methane Hydrate: Killer cause of Earth's greatest mass extinction. *Palaeoworld* 25(4):496-507.

Crichton, M. 1990. *Jurassic Park*. Alfred A. Knopf. New York.

Committee on Abrupt Climate Change, National Research Council. 2002. *Abrupt Climate Change: Inevitable Surprises*. NATIONAL ACADEMY PRESS Washington, D.C.

Holmes, R., S. Natali, S. Goetz, and P. Duffy. 2015. Permafrost and global climate change. Woods Hole Research Center Policy Brief. June 2015. http://whrc.org/wp-content/uploads/2015/06/PB_Permafrost.pdf

Inniss, L. A. Simcock, A. Ajawin, A. Alcala, P. Bernal, H. Calumpang, P. Araghi, S. Green, P. Harris, O. Kamara, K. Kohata, E. Marschoff, G. Martin, B. Ferreira, C. Park, R. Payer, J. Rice, A. Rosenberg, R. Ruwa, JT. Tuhumwire, S. Van Gaever, J. Wang, J. Weslawski "The First Global Integrated Marine Assessment" under the United Nations' Regular Process for Global Reporting and Assessment of the State of the Marine Environment, including Socioeconomic Aspects http://www.un.org/depts/los/global_reporting/WOA_RegProcess.htm

Kirschvink, J. and T. Raub. 2003. A methane fuse for the Cambrian explosion: carbon cycles and true polar wander. *C. R. Geoscience* 335 (2003) 65–78.

Marine Environmental Research Volume 102, December 2014, Pages 59-72

Melillo, Jerry M., Terese (T.C.) Richmond, and Gary W. Yohe, Eds., 2014: *Climate Change Impacts in the United States: The Third National Climate Assessment*. U.S. Global Change Research Program, 841 pp. doi:10.7930/J0Z31WJ2. <http://nca2014.globalchange.gov>

National Energy Technology Laboratory. 2011. Energy Resource Potential of Methane Hydrate. <https://www.netl.doe.gov/File%20Library/Research/Oil-Gas/methane%20hydrates/MH-Primer2011.pdf>

NOAA, National Centers for Environmental Information. 2017. *Global Climate Report -Annual 2016*. available online: <https://www.ncdc.noaa.gov/sotc/global/201613>

Parada, J., X. Feng, E. Hauerhof, R. Suzuki, U. Abubakar. 2012. The deep sea energy park: harvesting hydrothermal energy for seabed exploration. <https://eprints.soton.ac.uk/349890/>

Ruppel, C., and H. Hamilton. 2014. Natural Methane Seepage Is Widespread on the U.S. Atlantic Ocean Margin. *USGS Sound Waves*. <https://soundwaves.usgs.gov/2014/10/>

For Information and Feedback

We value your feedback on this lesson, including how you use it in your formal/informal education settings.

Please send your questions and comments to:

oceaneducation@noaa.gov

Acknowledgments

Produced by Mel Goodwin, PhD, Marine Biologist and Science Writer, Charleston, SC. Design/layout: Coastal Images Graphic Design, Charleston, SC. If reproducing this lesson, please cite NOAA as the source, and provide the following URL:

<http://oceanexplorer.noaa.gov>

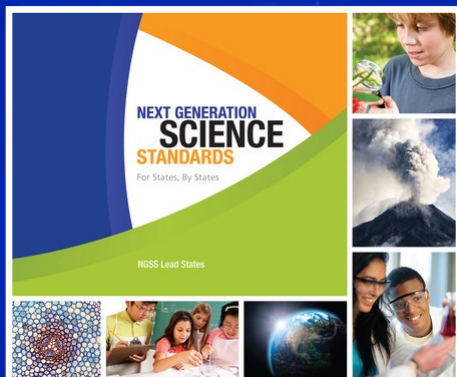

The Next Generation Science Standards

The Next Generation Science Standards integrate three dimensions within each standard: Science and Engineering Practices, Disciplinary Core Ideas, and Crosscutting Concepts. The standards are written as student performance expectations. While specific performance expectations may emphasize only a few of the practice categories, teachers are encouraged to utilize several practices in any instruction. Similarly, only a few crosscutting concepts may be emphasized, but this is not intended to limit instruction.

Ruppel, C, and J. Kessler. 2017. The interaction of climate change and methane hydrates. *Reviews of Geophysics*. 55(1): 126-168.

Santer, B., C. Mears, F. Wentz, K. Taylor, P. Gleckler, T. Wigley, T. Barnett, J. Boyle, W. Brüggemann, N. Gillett, S. Klein, G. Meehl, T. Nozawa, D. Pierce, P. Stott, W. Washington, and M. Wehner. 2007. Identification of human-induced changes in atmospheric moisture content. *PNAS* _ 104 (39):15248-15243.

Schaetzle, O. and C. Buisman. 2015. Salinity Gradient Energy: Current State and New Trends. *Engineering*(2):\64-166

Talling, P., M. Clare, M. Urlaub, E. Pope, J. Hunt, and S. Watt. 2014. Large Submarine Landslides on Continental Slopes: Geohazards, Methane Release, and Climate Change. *Oceanography* 27(2):32-45

USGS Volcano Hazards Program, <https://volcanoes.usgs.gov/vhp/gas.html>

Van Dover, C. 2014. Impacts of anthropogenic disturbances at deep-sea hydrothermal vent ecosystems: A review. *Marine Environmental Research* 102:59-72.

Next Generation Science Standards

This lesson supports the *Ocean Literacy Essential Principles and Fundamental Concepts* as indicated here http://oceanexplorer.noaa.gov/oceanos/edu/collection/media/wdwe_standards.pdf. Additionally, while this lesson not intended to target specific Next Generation Science Standards (NGSS), activities in the lesson may be used to address specific elements of the NGSS as described below.

Some Suggestions for Using Lesson Content to Address Specific NGSS Performance Expectations:

5-ESS2-1. Develop a model using an example to describe ways the geosphere, biosphere, hydrosphere, and/or atmosphere interact. **[Clarification Statement: Examples could include the influence of the ocean on ecosystems, landform shape, and climate; the influence of the atmosphere on landforms and ecosystems through weather and climate; and the influence of mountain ranges on winds and clouds in the atmosphere. The geosphere, hydrosphere, atmosphere, and biosphere are each a system.]**

Discuss the interactions of atmospheric warming with sea temperature, salinity, and oceanic circulation; and/or interactions between atmospheric chemistry and ocean acidification; and/or effects of these interactions on the biosphere.

5-ESS3-1. Obtain and combine information about ways individual communities use science ideas to protect the Earth's resources and environment.

Discuss ways that ocean exploration ("science ideas") can be used to address ocean health issues.

MS-ESS2-6. Develop and use a model to describe how unequal heating and rotation of the Earth cause patterns of atmospheric and oceanic circulation that determine regional climates. [Clarification Statement: Emphasis is on how patterns vary by latitude, altitude, and geographic land distribution. Emphasis of atmospheric circulation is on the sunlight-driven latitudinal banding, the Coriolis effect, and resulting prevailing winds; emphasis of ocean circulation is on the transfer of heat by the global ocean convection cycle, which is constrained by the Coriolis effect and the outlines of continents. Examples of models can be diagrams, maps and globes, or digital representations.]

Discuss how unequal heating and Earth's rotation are involved with the THC, and how the THC affects regional climates.

HS-ESS2-2. Analyze geoscience data to make the claim that one change to Earth's surface can create feedbacks that cause changes to other Earth systems. [Clarification Statement: Examples should include climate feedbacks, such as how an increase in greenhouse gases causes a rise in global temperatures that melts glacial ice, which reduces the amount of sunlight reflected from Earth's surface, increasing

surface temperatures and further reducing the amount of ice. Examples could also be taken from other system interactions, such as how the loss of ground vegetation causes an increase in water runoff and soil erosion; how dammed rivers increase groundwater recharge, decrease sediment transport, and increase coastal erosion; or how the loss of wetlands causes a decrease in local humidity that further reduces the wetland extent.]

Discuss feedbacks that are relevant to rising atmospheric temperatures, melting snow and sea ice, changes to the THC, and biological responses to increased atmospheric carbon dioxide concentrations.

HS-ESS2-4. Use a model to describe how variations in the flow of energy into and out of Earth's systems result in changes in climate. [Clarification Statement: Examples of the causes of climate change differ by timescale, over 1-10 years: large volcanic eruption, ocean circulation; 10-100s of years: changes in human activity, ocean circulation, solar output; 10-100s of thousands of years: changes to Earth's orbit and the orientation of its axis; and 10-100s of millions of years: long-term changes in atmospheric composition.]

Use a model to explain how greenhouse gases modify the flow of energy into and out of Earth's systems.

HS-ESS3-4. Evaluate or refine a technological solution that reduces impacts of human activities on natural systems.* [Clarification Statement: Examples of data on the impacts of human activities could include the quantities and types of pollutants released, changes to biomass and species diversity, or areal changes in land surface use (such as for urban development, agriculture and livestock, or surface mining). Examples for limiting future impacts could range from local efforts (such as reducing, reusing, and recycling resources) to large-scale geoenvironmental design solutions (such as altering global temperatures by making large changes to the atmosphere or ocean).]

* Performance expectations marked with an asterisk integrate traditional science content with engineering through a Practice or Disciplinary Core Idea.

Consider technological solutions to one or more ocean health issues; or how energy from ocean systems might reduce human impacts on natural systems.

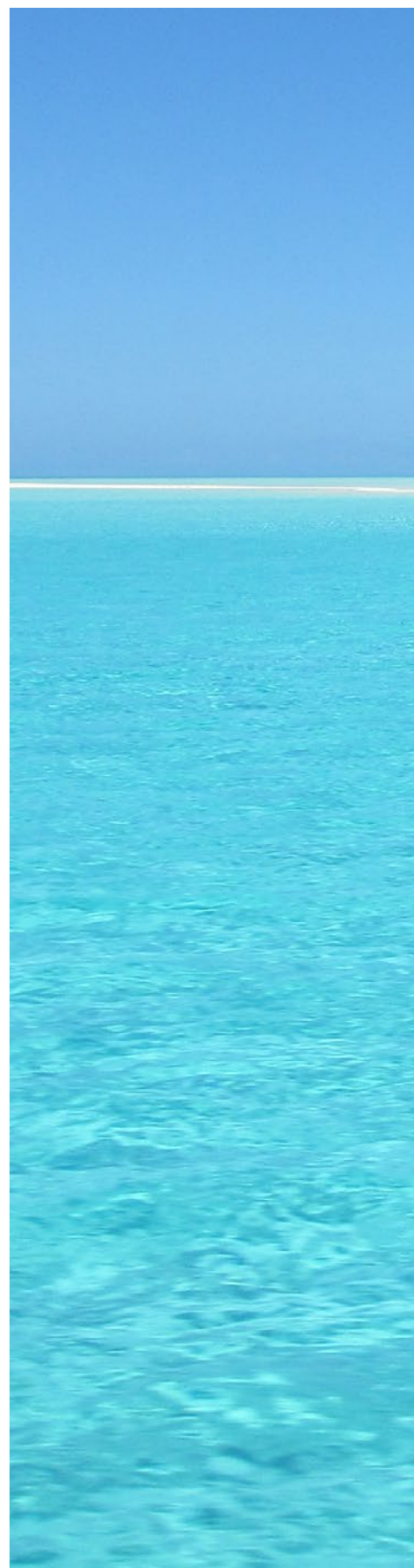



What's the Big Deal?

Focus

Significance of methane hydrates

Grade Level

Target Grade Level: 9-12 (Earth Science)

Focus Question

Why should a NOAA Ocean Exploration and Research expedition focus investigations on methane hydrates?

Learning Objectives

- Students will define methane hydrates, describe where these substances are typically found, and explain how they are believed to be formed.
- Students will ask questions to clarify evidence that methane hydrates could be involved with changes to Earth systems.
- Students will describe how additional knowledge of methane hydrates during Ocean Exploration and Research expeditions could provide human benefits.

Materials

- Copies of *Methane Hydrate Investigation Guide*, one for each student group
- Copies of the *Methane Hydrate Model Construction Guide*, one for each student group
- Materials for constructing a methane hydrate model:
 - For constructing a pentagon:*
 - Paper, unlined 8-1/2" X 11"
 - Pencil
 - Protractor or compass
 - For constructing the half dodecahedron, clathrate cage, methane molecule and methane hydrate model:*
 - Scissors
 - Cardboard or card stock (enough to make 7 pentagons)
 - Pentagon template
 - Ruler, 12-inch
 - Fishing line, or light colored thread

Fire ice. Methane hydrates burn and drip water. Image courtesy J. Pinkston and L. Stern USGS.



- Toothpicks (34 per table - 30 blue, 4 red)
- Gumdrop candy (such as “Tootsie Dots”) (20 of one color, 4 of another color, and 1 of a third color, per table)

Audiovisual Materials

- None

Teaching Time

One or two 45-minute class periods plus time for student research

Seating Arrangement

Five groups of 3-6 students

Maximum Number of Students

32

Key Words and Concepts

Cold seeps
Methane hydrate
Methanogenic Archaea
Clathrate
Greenhouse gas
Greenhouse effect
Paleocene extinction
Cambrian explosion
Alternative energy
Natural hazards

Background Information

NOTE: Explanations and procedures in this lesson are written at a level appropriate to professional educators. In presenting and discussing this material with students, educators may need to adapt the language and instructional approach to styles that are best suited to specific student groups.

“Methane trapped in marine sediments as a hydrate represents such an immense carbon reservoir that it must be considered a dominant factor in estimating unconventional energy resources; the role of methane as a ‘greenhouse’ gas also must be carefully assessed.”

Gas (Methane) Hydrates -- A New Frontier; Dr. William Dillon, U.S. Geological Survey; http://physics.oregonstate.edu/~hetheriw/projects/energy/topics/doc/fuels/fossil/methane_hydrate/methane_hydrate_japan_geo_survey/usgs_hydrate.html

Methane hydrate is a type of clathrate, a chemical substance in which the molecules of one material (water, in this case) form

When ice-rich permafrost thaws, former tundra and forest turns into a thermokarst lake as the ground subsides. The carbon stored in the formerly frozen ground is consumed by the microbial community, who release methane gas. When lake ice forms in the winter, methane gas bubbles are trapped in the ice. Image courtesy of Miriam Jones, U.S. Geological Survey. <https://www.usgs.gov/media/images/methane-bubbles-trapped-thermokarst-lake-ice>

an open lattice that encloses molecules of another material (methane) without actually forming chemical bonds between the two materials. Methane is produced in many environments by a group of Archaea known as methanogenic Archaea. These Archaea obtain energy by anaerobic metabolism through which they break down the organic material contained in once-living plants and animals. When this process takes place in deep ocean sediments, methane molecules are surrounded by water molecules, and conditions of low temperature and high pressure allow stable ice-like methane hydrates to form.

Methane hydrate deposits are significant for several reasons. A major interest is the possibility of methane hydrates as an energy source. The U.S. Geological Survey has estimated that on a global scale, methane hydrates may contain roughly twice the carbon contained in all reserves of coal, oil, and conventional natural gas combined. At present, however, no technology exists to exploit methane hydrates for energy.

In addition to their potential importance as an energy source, scientists have found that methane hydrates are associated with unusual and possibly unique biological communities. In September 2001, the NOAA Ocean Exploration Deep East Expedition explored the crest of the Blake Ridge at a depth of 2,154 m, and found methane hydrate-associated communities containing previously unknown species that may be sources of beneficial pharmaceutical materials.

Methane hydrates remain stable in deep-sea sediments for long periods of time; but if the surrounding temperature rises the clathrates may become unstable and release free methane gas. This is probably happening now in at least two settings. In the deep ocean, as sediments become deeper and deeper they are heated by the Earth's core; eventually to a point at which free methane gas is released. (At a water depth of 2 km, this point is reached at a sediment depth of about 500 m. *See Phase Diagram on page 7.*) Methane hydrates are also widespread on continental margins and permafrost areas. Here, oceanic and atmospheric warming may also make hydrates unstable and lead to methane release into overlying sediments and soils (Ruppel and Kessler, 2016). In deepwater sediments, pressurized methane remains trapped beneath hundreds of meters of sediments that are cemented together by still-frozen methane hydrates. On continental shelves, methane may be released as bubbles at the seafloor. Areas where this is happening are called methane seeps. Not all methane seeps are caused by decomposing methane hydrates; many are probably the result of microbial activity in shallow sediments (Ruppel and Hamilton, 2014).

Recent ocean exploration expeditions have found that methane seeps may be much more abundant than previously realized. In 2012, a series of acoustic images from the NOAA Ship *Okeanos*

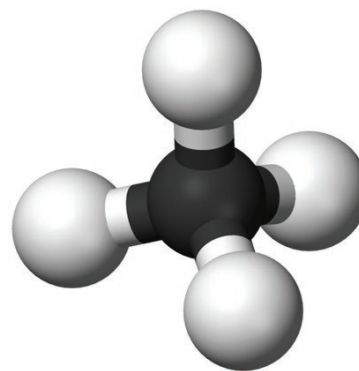

Methane is composed of one carbon atom surrounded by four hydrogen atoms. It is the simplest hydrocarbon. Image courtesy of NOAA OER, INSPIRE Chile Margin 2010.

<http://oceanexplorer.noaa.gov/explorations/10chile/background/methane/media/methane1.html>

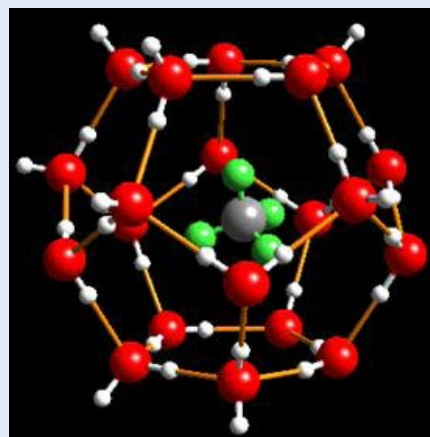

Water molecules (1 red oxygen and 2 white hydrogens) form a pentagonal dodecahedron around a methane molecule (1 gray carbon and 4 green hydrogens). This represents 2 of the 8 parts of the typical Structure I gas hydrate molecule.

<https://woodshole.er.usgs.gov/project-pages/hydrates/primer.html>

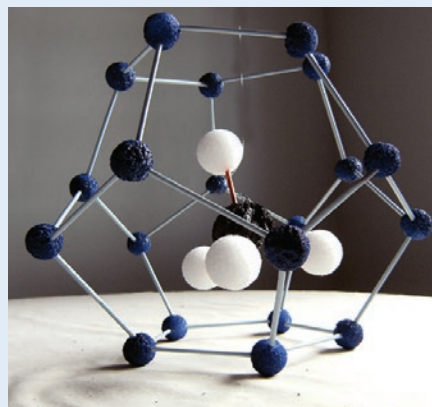

Build your own model of a methane hydrate! See page 15. Image courtesy of Mellie Lewis.

Explorer suggested that there might be dozens of previously unknown seafloor methane seeps on the U.S. Atlantic margin from Cape Hatteras to Georges Bank. Continued exploration discovered many more seeps, and by 2014 more than 550 newly-discovered methane seeps had been identified on the northern U.S. Atlantic margin (Skarke et al., 2014). In 2017, NOAA's Office of Ocean Exploration and Research joined with the U.S. Geological Survey (USGS), and the U.S. Department of Energy to support the Interagency Mission for Methane Research at Seafloor Seeps expedition to focus on the geology, ecology, chemistry, and physics of methane seeps on the U.S. Mid-Atlantic margin between Baltimore Canyon and Hatteras Canyon at water depths of 400-1,600 meters (<https://woodshole.er.usgs.gov/project-pages/hydrates/mission-immerss.html>). On the Pacific coast, several methane hydrate ecosystems along the coast of Washington have been extensively studied, and oceanographic and geologic conditions suggest similar habitats should stretch all along the Cascadia Subduction Zone. In 2016, E/V *Nautilus* conducted the first comprehensive study of the region using advanced multibeam mapping technology, discovering 450 methane bubble streams and two new sites of methane hydrate exposure on the seafloor.

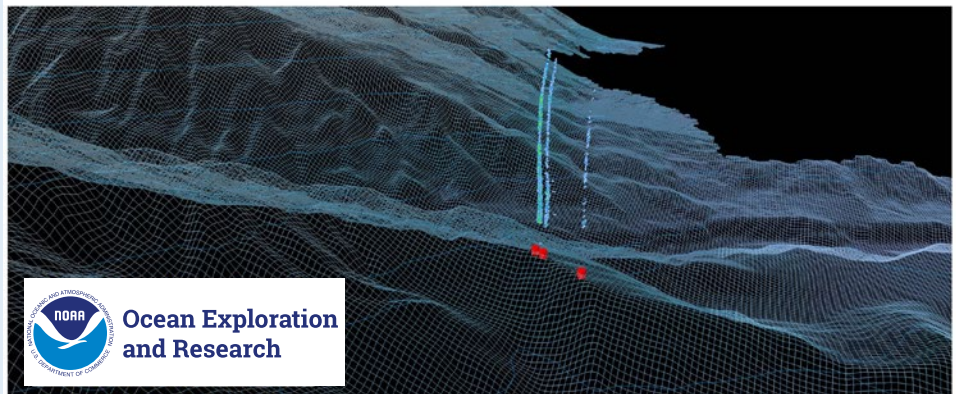
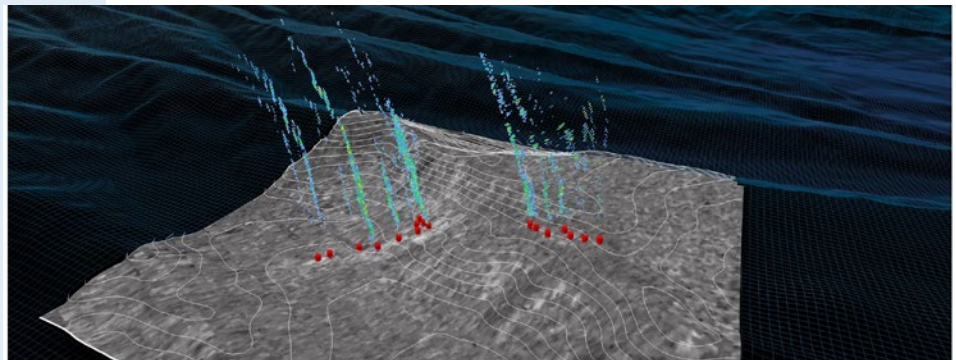
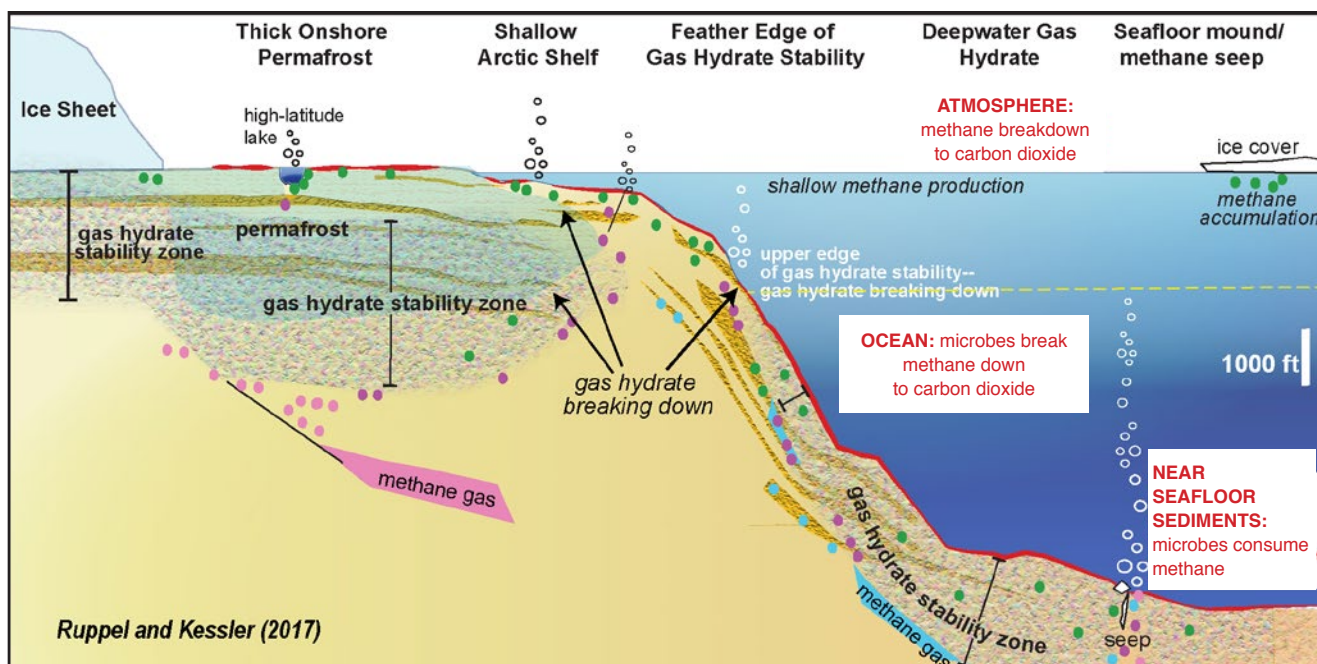

Image of gaseous seeps derived from water column acoustic reflectivity observations and associated bathymetry and seafloor backscatter. Image courtesy of NOAA OER, Northeast and Mid-Atlantic Canyons Expedition 2012.
<http://oceanexplorer.noaa.gov/oceanos/explorations/ex1206/summary/seeps.html>

While these discoveries are exciting, there has also been concern about the possible effects of methane release. In 1995, Australian paleoceanographer Gerald Dickens suggested that a sudden release of methane from submarine sediments during the Paleocene Epoch (at the end of the Tertiary Period, about 55 million years ago) caused a greenhouse effect that raised the temperatures in the deep ocean by about 6° C. The result was the



extinction of many deep-sea organisms known as the Paleocene extinction event. Kirschvink and Raub, (2003), on the other hand, suggested that methane released from methane hydrates is a possible cause of the dramatic increase in biodiversity that took place during the Cambrian Period. Other concerns have focused on the possibility that sudden release of methane might trigger submarine landslides that could cause disastrous tsunamis.

Recent research, however, has found that while large quantities of methane may have been released at various points in Earth's history, the time scale of these releases is on the order of thousands of years, rather than sudden catastrophic releases (Archer, 2007). The available evidence also does not show a strong relationship between submarine landslides and methane emissions (Talling et al., 2014). While current warming of ocean waters is probably causing some gas hydrate deposits to break down, this is unlikely to lead to massive amounts of methane being released to the atmosphere because the annual emissions of methane to the ocean from these deposits is very small, and most of the methane released by gas hydrates never reaches the atmosphere (Ruppel and Kessler, 2017). Methane in the water column, though, can be oxidized to carbon dioxide, which increases the acidity of ocean waters and reduces oxygen levels.

At present, there is no known technology for tapping methane hydrates as a source of useful energy. Current research in the U.S. and other countries is focused on the feasibility of methane hydrates as an energy source, as well as interactions between climate change and gas hydrates (Ruppel and Hamilton, 2014).

This lesson guides a student investigation into the significance of methane hydrates.

Summary of the locations where gas hydrate occurs beneath the seafloor, in permafrost areas, and beneath some ice sheets, along with the processes (shown in red) that destroy methane (sinks) in the sediments, ocean, and atmosphere. The differently colored circles denote different sources of methane. Gas hydrates are likely breaking down now on shallow continental shelves in the Arctic Ocean and at the feather edge of gas hydrate stability on continental margins (1000-1650 feet). Image courtesy Ruppel and Kessler (2017)

<https://www.usgs.gov/media/images/gas-hydrate-schematic>



Chemosynthetic mussels encrusting a carbonate mound at one of the so-called Norfolk Canyon seeps at ~1,400 meters water depth. Bubbles that make up one of the observed water column plumes are visible in the center. Image courtesy of NOAA OER, 2013 Northeast U.S. Canyons Expedition.

<http://oceanexplorer.noaa.gov/explorations/17atlantic-margin/media/norfolk.html>



Participants at an Exploring the Deep Ocean with NOAA professional development workshop mastering the methane hydrate model. Image courtesy of NOAA.



NOAA Ship Okeanos Explorer. Image courtesy of NOAA. <http://oceanexplorer.noaa.gov/okeanos/explorations/ex1702/logs/mar1/media/okeanos.html>



Scientist Scott France participates in the dives from his home office via telepresence. Image courtesy of NOAA OER, 2016 Deepwater Exploration of the Marianas. <http://oceanexplorer.noaa.gov/okeanos/explorations/ex1605/logs/jun28/media/1605scott-france.html>

Learning Procedure

1. To prepare for this lesson:

- Review introductory information on the NOAA Ship *Okeanos Explorer* at <http://oceanexplorer.noaa.gov/okeanos/about.html> and <http://oceanexplorer.noaa.gov/okeanos/welcome.html>. You may also want to consider having students complete some or all of the lesson, *To Boldly Go....* http://oceanexplorer.noaa.gov/okeanos/edu/collection/media/wdwe_toboldlygo.pdf
- Visit:

<http://oceanexplorer.noaa.gov/explorations/deepeast01/logs/oct1/oct1.html> and <http://oceanexplorer.noaa.gov/explorations/03windows/welcome.html> for background on the 2001 Deep East Expedition to the Blake Ridge and the 2003 Windows on the Deep Expedition;

“Exploration of Cold Seeps on the North Atlantic Continental Margin” by Taylor Heyl oceanexplorer.noaa.gov/okeanos/explorations/ex1304/background/coldseeps/welcome.html;

“Methane in the Ocean” by Monica Heintz

<http://oceanexplorer.noaa.gov/explorations/10chile/background/methane/methane.html>;

[http://oceanexplorer.noaa.gov/explorations/17atlantic-](http://oceanexplorer.noaa.gov/explorations/17atlantic-margin/welcome.html)

[margin/welcome.html](http://oceanexplorer.noaa.gov/explorations/17atlantic-margin/welcome.html) for background on the 2017 Exploring Methane Seeps on the U.S. Mid-Atlantic Margin: IMMERS expedition.

and

<http://www.nautiluslive.org/expedition/2016> for background on the 2016 E/V *Nautilus* Seeps and Ecosystems of the Cascadia Margin expedition.

- Review questions on the *Methane Hydrates Investigation Guide*.
- Review procedures on the *Methane Hydrate Model Construction Guide*, and gather necessary materials. This activity may be done as a cross-curricular mathematics lesson using student-constructed pentagons and dodecahedrons. Correlations with Common Core State Standards for Mathematics are provided in Appendix A.

2. Briefly introduce the ships of exploration NOAA Ship *Okeanos Explorer*, E/V *Nautilus*, and R/V *Falkor*; (see *Introduction to the Ships and Their Exploration Strategy* <http://oceanexplorer.noaa.gov/okeanos/edu/collection/media/hdwe-StrategyBkgnd.pdf>) and the 2017 Discovering the Deep: Exploring Remote Pacific MPAs Expedition <http://oceanexplorer.noaa.gov/okeanos/explorations/ex1703/background/plan/welcome.html>.

Briefly discuss why this kind of exploration is important (for background information, please see the lesson, *To Boldly Go* http://oceanexplorer.noaa.gov/okeanos/edu/collection/media/wdwe_toboldlygo.pdf). Highlight the overall strategy used by ships of exploration, including the following points:

- The overall strategy is to develop baseline information about the biological, geological, and water chemistry features of unexplored areas to provide a foundation for future exploration and research.

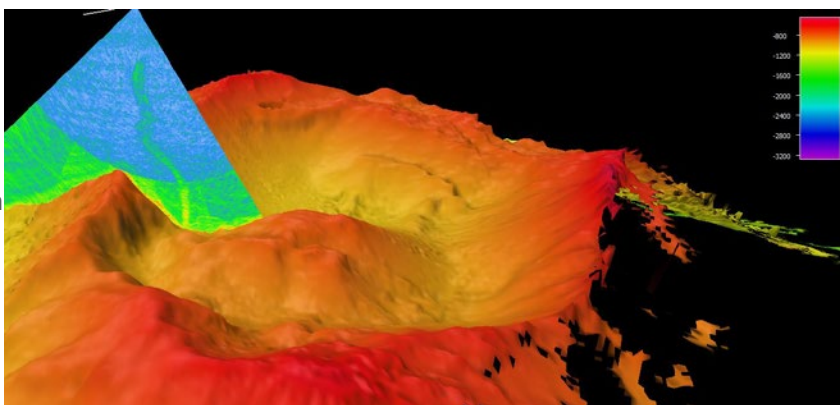

- This information includes:
 - High resolution maps of the area being explored, as well as areas that the ship crosses while underway from one location to the next (underway reconnaissance)
 - Exploration of water column chemistry and other features
 - High definition close-up video of biological and geological features in the exploration area (site characterization)

- This strategy relies on four key technologies:
 - Multibeam sonar mapping system and other types of sonar that can detect specific features in the water column and on the seafloor;
 - Conductivity, Temperature, and Depth profilers (CTD) and other electronic sensors to measure chemical and physical seawater properties;
 - A Remotely Operated Vehicle (ROV) capable of obtaining high-quality imagery and samples in depths as great as 6,000 meters; and
 - Telepresence technologies that allow scientists with many different areas of expertise to observe and interact with exploration activities, though they may be thousands of miles from the ship.

You may want to show some or all of the images in the adjacent sidebar to accompany this review.

Lead an introductory discussion about the 2017 Exploring Methane Seeps on the U.S. Mid-Atlantic Margin: IMMeRSS expedition. Depending upon available time, you may also want to include information from one or more of the other expeditions referenced above. Briefly describe methane hydrates and why these substances are potentially important to human populations. You may also want to visit http://oceanexplorer.noaa.gov/edu/themes/cold_seeps/welcome.html for more information and activities on cold seeps.

3. Provide each student group with a copy of the *Methane Hydrates Investigation Guide* and the *Methane Hydrate Model*

Sometimes form wins—*Deep Discoverer* (D2) is an elegant and powerful 9,000 pounds, designed to bring optimal imagery topside, where it is then shipped to shore in real time. Image courtesy of NOAA OER, Gulf of Mexico 2014 Expedition.

<http://oceanexplorer.noaa.gov/oceanos/explorations/ex1402/logs/apr15/media/drfront.html>

Multibeam sonar imagery shows a plume of bubbles rising from the seafloor at Vailulu'u Seamount near American Samoa. Image courtesy of NOAA OER, 2017 American Samoa Expedition.

<http://oceanexplorer.noaa.gov/oceanos/explorations/ex1702/logs/feb22/media/vailulu2.html>

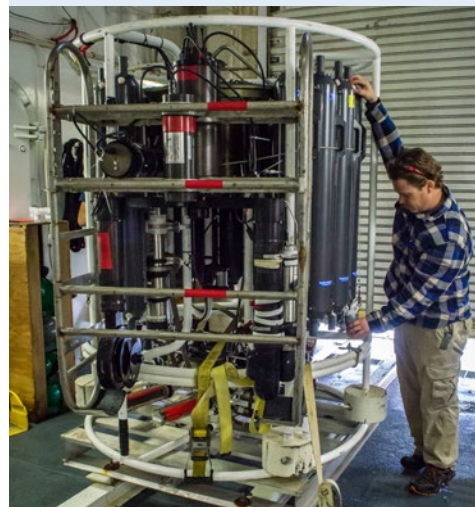

Water samples are collected from the Niskin bottles on the CTD. All 20 Niskin bottles take water samples from various depths, starting near the seafloor and ending close to the surface. Image courtesy NOAA OER, The Hidden Ocean 2016: Chukchi Borderlands. <http://oceanexplorer.noaa.gov/explorations/16arctic/logs/july24/media/shipton.html>



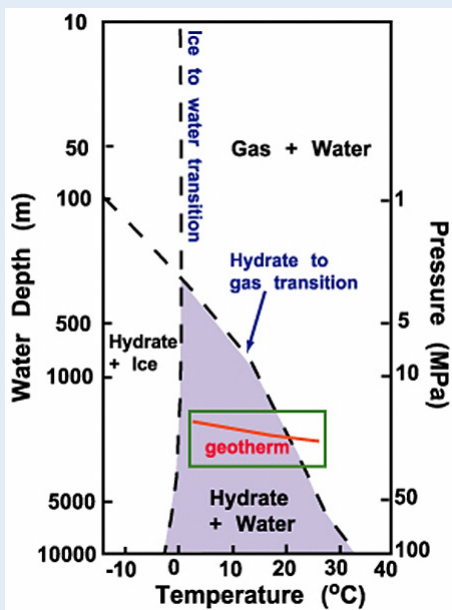

Phase diagram showing the water depths (and pressures) and temperatures for gas hydrate (purple area) stability. The Windows to the Deep expedition explores areas of the Blake Ridge and Carolina Rise in which the uppermost sediments lie within the range denoted by the green box. The red line shows a geotherm or temperature in the Earth as a function of depth. Note that, at greater depths in the sediments, the geotherm crosses from the hydrate zone (purple region) to the gas zone. This means that gas hydrate in sediments usually overlies free gas.

http://oceanexplorer.noaa.gov/explorations/03windows/background/hydrates/media/fig1_phase_diagram.html



An aggregation of methane ice worms inhabiting a white methane hydrate seen in the Gulf of Mexico, 2012. Studies suggest that these worms eat chemoautotrophic bacteria that are living off of chemicals in the hydrate. Image courtesy of NOAA OER.

http://oceanexplorer.noaa.gov/oceanos/explorations/ex1202/logs/dailyupdates/media/apr12_update.html

Construction Guide. Tell students that they will be expected to present a group report, including a model of a methane hydrate, that addresses these questions, and participate in a class discussion of their results.

- Lead a discussion of students' research results. Referring to students' models, begin with a discussion of what methane hydrates are, where they are found, and how they are formed. Next, ask for a group that can explain one way in which methane hydrates are significant to humans. Continue this process until all five groups have had a chance to present one piece of the whole story. Now, ask students what scientific research priorities and public policies should be established concerning methane hydrates. Encourage students to comment on the potential significance of climate change, alternative energy sources, useful biological products, and natural hazards.

Be sure the following points are included in the discussion:

- A clathrate is a chemical substance in which molecules of one material (e.g., water) form an open solid lattice that encloses, without chemical bonding, molecules of another material (e.g., methane).
- Methane hydrate is a clathrate in which a lattice of water molecules encloses a molecule of methane.
- In general, methane hydrates formed under conditions of low temperature and high pressure, such as are found in deep ocean environments. See http://oceanexplorer.noaa.gov/explorations/03windows/background/hydrates/media/fig1_phase_diagram.html for a phase diagram illustrating combinations of pressure and temperature that are suitable for methane hydrate formation.
- Clathrates have been known as a type of chemical substance since the 1800's, but methane hydrates first received serious attention when they were found to be plugging natural gas pipelines, particularly pipelines located in cold environments. In the late 1960s, methane hydrate was observed in subsurface sediments in Western Siberia and Alaska. Marine methane hydrate deposits were first found in the Black Sea and subsequently in cores of ocean bottom sediments collected by the R/V *Glomar Challenger* from many areas of Earth's ocean.
- Methane is a greenhouse gas that is ten times more effective than carbon dioxide in causing climate warming. Carbon isotope variations in carbonate rocks and sediments indicate that large-scale releases of methane from ocean hydrates could have occurred at various times in Earth's

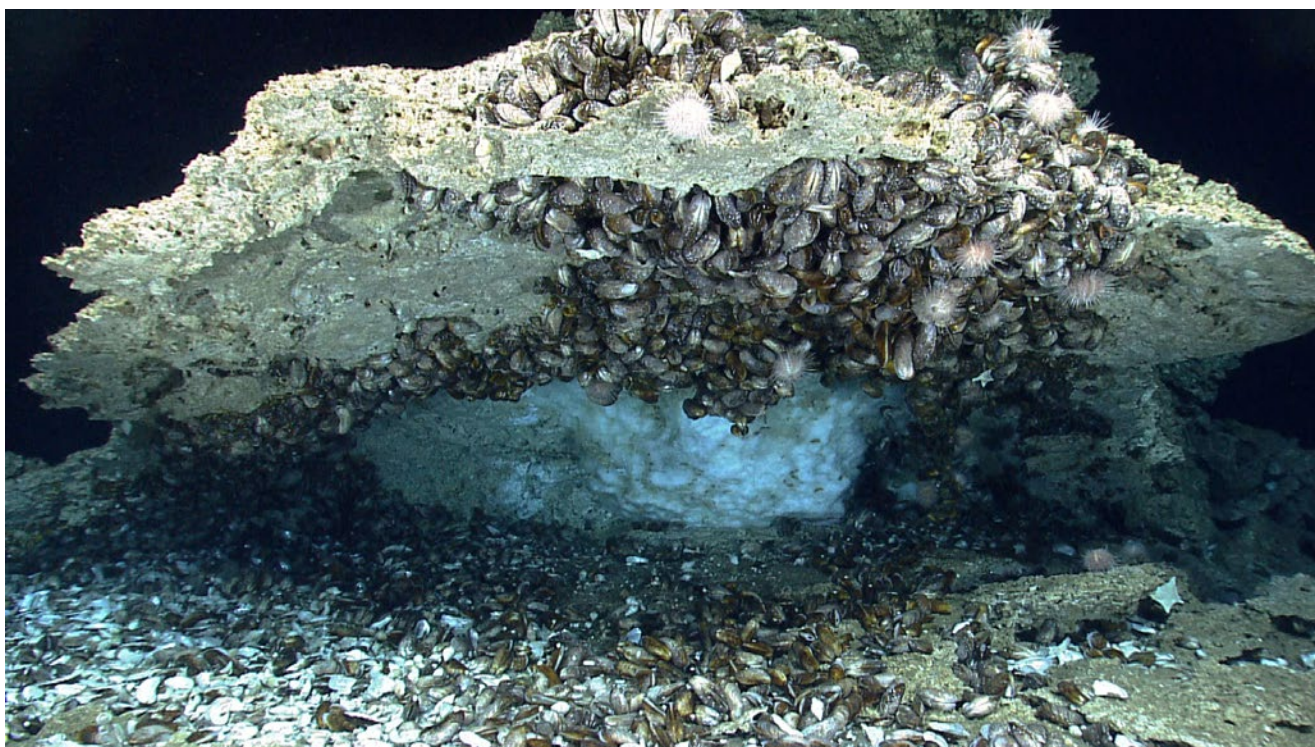

history, including the Pre-Cambrian and Cretaceous Periods. Such releases could have caused significant climate change that may be related to extinction events, as well as to the rapid evolution of new species during the Cambrian Period.

- Methane can be released from methane hydrates when deposits are disrupted by earthquakes or landslides; or when pressure on hydrates is reduced due to a sea-level drop, such as occurred during glacial periods; or when clathrates become unstable due to warming.
- Methane is a fossil fuel that could be used in many of the same ways that other fossil fuels (e.g., coal and petroleum) are used. According to the U.S. Department of Energy, the quantity of methane potentially available is enormous. For example, the U.S. domestic natural gas recoverable resource is roughly 2,300 trillion cubic feet (Tcf). In the case of methane hydrates, the domestic resource base could be on the order of 5,000 Tcf (in 2016, the total U.S. consumption of natural gas was about 27 Tcf. 5,000 Tcf is more than ten times the volume of Lake Superior).
- Oil and gas drilling and production activities may disturb methane hydrate deposits that are near the seafloor surface, and such disruption poses hazards to personnel and equipment. Ongoing natural phenomena (e.g., subsidence and uplift of the seafloor, global climatic cycles, changes in ocean circulation patterns, changes in global sea level) continually alter the temperature and pressure conditions in sea-bottom sediments. These processes affect the

The first dive of the 2014 Gulf of Mexico Expedition had a fantastic "amphitheater of chemosynthetic life." Here we saw bathymodiolus mussels, methane hydrate or ice, and ice worms. There were also a number of sea urchins, sea stars, and fish in this area. Most impressive was the large accumulation of hydrate mussels on the underside of the ledge. Image courtesy of NOAA OER, Gulf of Mexico 2014 Expedition.

http://oceanexplorer.noaa.gov/oceanos/explorations/ex1402/logs/highlight_imgs/media/ampitheater.html



Methane hydrates are extremely difficult to study, and could either be an important energy source or a source of methane, a greenhouse gas that is 20 times more potent than CO₂. These reasons led a Norwegian, Dutch and Chinese research team to explore the mechanical properties of this poorly understood substance. Credit: Geir Mogen, NTNU
Read more at:
<https://phys.org/news/2015-11-key-properties-methane-hydrates-permafrost.html>

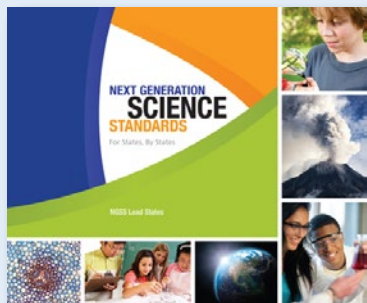

The Next Generation Science Standards

The Next Generation Science Standards integrate three dimensions within each standard: Science and Engineering Practices, Disciplinary Core Ideas, and Crosscutting Concepts. The standards are written as student performance expectations and each combines Science and Engineering Practices, Disciplinary Core Ideas, and Crosscutting Concepts. While specific performance expectations may emphasize only a few of the practice categories, teachers are encouraged to utilize several practices in any instruction. Similarly, only a few crosscutting concepts may be emphasized, but this is not intended to limit instruction.

stability of natural methane hydrates, and can result in potentially massive destabilization of these hydrates. If a large quantity of methane enters the atmosphere, it will reside there for roughly 10-20 years, during which it will act as a very efficient greenhouse gas. Over the longer term, the atmospheric impact of methane will continue at lesser levels as the methane slowly dissipates through oxidation into water and carbon dioxide.

- In 2001, the Deep East Expedition explored the crest of the Blake Ridge at a depth of 2,154 m, and found methane hydrate-associated communities containing species that may be sources of beneficial pharmaceutical materials. Since then, expeditions supported by NOAA's Office of Ocean Exploration and Research have discovered more than 550 previously unknown methane seeps on the northern U.S. Atlantic margin, and more than 450 seeps on the northwestern U.S. Pacific coast.

The BRIDGE Connection

www.vims.edu/bridge/ – Scroll over “Ocean Science Topics,” then click “Habitats,” the “Deep Sea” for links to resources about hydrothermal vents and chemosynthetic communities.

The “Me” Connection

Have students write an essay describing why ocean exploration expeditions are, or are not, personally relevant and important.

Connections to Other Subjects

English/Language Arts, Biology, Chemistry, Mathematics

Assessment

Students' responses to *Investigation Guide* questions and class discussions provide opportunities for assessment.

Extensions

1. Follow events aboard the *Okeanos Explorer* at <http://oceanexplorer.noaa.gov/okeanos/welcome.html>.
2. Have students investigate events in Earth's history that may have been influenced in some way by methane hydrates. The next-to-last paragraph in the Background section refers to some of these.

Multimedia Discovery Missions

<http://www.oceanexplorer.noaa.gov/edu/learning/welcome.html>
Click on the links to Lessons 5 and 11 for interactive multimedia presentations and Learning Activities on Chemosynthesis and Hydrothermal Vent Life, and Energy from the Oceans.

Other Relevant Lessons from NOAA OER

(All of the following Lessons are targeted toward grades 9-12)

This Life Stinks

http://oceanexplorer.noaa.gov/edu/lessonplans/03win_lifestinks.pdf

Focus: Methane-based chemosynthetic processes (Physical Science)

Students will define the process of chemosynthesis, and contrast this process with photosynthesis. Students will also explain the process of methane-based chemosynthesis and explain the relevance of chemosynthesis to biological communities in the vicinity of cold seeps.

The Big Burp: Where's the Proof?

<http://oceanexplorer.noaa.gov/explorations/07mexico/background/edu/media/burp.pdf>

Focus: Potential role of methane hydrates in climate change (Earth Science)

Students will describe the overall events that occurred during the Cambrian Explosion and Paleocene Extinction events and will define methane hydrates and hypothesize how these substances could contribute to climate change. Students will also describe and explain evidence to support the hypothesis that methane hydrates contributed to the Cambrian Explosion and Paleocene Extinction events.

The Benthic Drugstore

<http://oceanexplorer.noaa.gov/explorations/07twilightzone/background/edu/media/drugstore.pdf>

Focus: Pharmacologically-active chemicals derived from marine invertebrates (Life Science/Chemistry)

Students will identify at least three pharmacologically-active chemicals derived from marine invertebrates, describe the disease-fighting action of at least three pharmacologically active chemicals derived from marine invertebrates, and infer why sessile marine invertebrates appear to be promising sources of new drugs.



Squat lobsters, shrimp, and scaleworms crawl on mussels. The squat lobsters appear "hairy" because of bacteria growing on their shells. Image courtesy of NOAA OER, Submarine Ring of Fire 2014.

<http://oceanexplorer.noaa.gov/explorations/14fire/logs/december09/media/mussels-lobsters.html>

The mussel, *Bathymodiolus brevior*, is one of those hosts with symbiotic bacteria embedded in the gill tissue. Thus, the mussel needs to grow near vent water to supply hydrogen sulphide, oxygen, and carbon dioxide to its symbionts. Similar mussels at vents around the world can dominate the biomass of the community. See the following daily log for more information on these communities:

https://oceanexplorer.noaa.gov/explorations/14fire/logs/photolog/photolog.html#cbpi=/explorations/14fire/logs/december02/media/urashima_chimneys.html

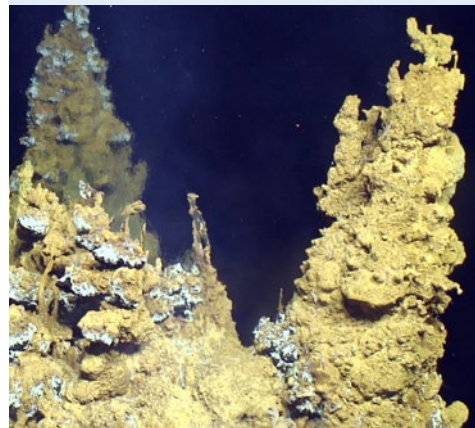

Sulfide chimneys coated with iron-based microbial mat at the Urashima vent site. Image courtesy of NOAA OER, Submarine Ring of Fire 2014.

http://oceanexplorer.noaa.gov/explorations/14fire/logs/december02/media/urashima_chimneys.html



Right: Deep-sea hydrothermal vents are dynamic and extremely productive biological ecosystems supported by chemosynthetic microbial primary production. In the absence of photosynthesis, these microorganisms derive energy via the oxidation of reduced chemicals emitted in hydrothermal fluids. Photograph of iron-oxide-encrusted microbial mat. Image courtesy NOAA OER Submarine Ring of Fire 2014.

<http://oceanexplorer.noaa.gov/explorations/14fire/background/microbio/microbio.html>

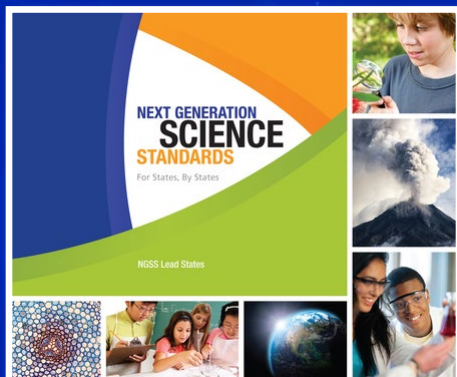

The Next Generation Science Standards

The Next Generation Science Standards integrate three dimensions within each standard: Science and Engineering Practices, Disciplinary Core Ideas, and Crosscutting Concepts. The standards are written as student performance expectations. While specific performance expectations may emphasize only a few of the practice categories, teachers are encouraged to utilize several practices in any instruction. Similarly, only a few crosscutting concepts may be emphasized, but this is not intended to limit instruction.

Chemosynthesis for the Classroom

http://oceanexplorer.noaa.gov/explorations/06mexico/background/edu/gom_06_chemo.pdf

Focus: Chemosynthetic bacteria and succession in chemosynthetic communities (Chemistry/Biology)

Students will observe the development of chemosynthetic bacterial communities and will recognize that organisms modify their environment in ways that create opportunities for other organisms to thrive. Students will also explain the process of chemosynthesis and the relevance of chemosynthesis to biological communities in the vicinity of cold seeps.

Other Resources

- Archer, D. 2007. Methane hydrate stability and anthropogenic climate change. *Biogeosciences Discuss.* 4:993–1057; www.biogeosciences-discuss.net/4/993/2007/
- Dickens, G., J. O’Neil, D. Rea, and R. Owen. 1995. Dissociation of oceanic methane hydrate as a cause of the carbon isotope excursion at the end of the Paleocene. *Paleoceanography* 10(6):965–971.
- Kirschvink, J., and T. Raub. 2003. A methane fuse for the Cambrian explosion: carbon cycles and true polar wander. *C. R. Geoscience* 335:65–78.
- Ruppel, C., and H. Hamilton. 2014. Natural Methane Seepage Is Widespread on the U.S. Atlantic Ocean Margin. *USGS Sound Waves*. <https://soundwaves.usgs.gov/2014/10/>
- Ruppel, C., and J. Kessler. 2017. The interaction of climate change and methane hydrates. *Reviews of Geophysics*. 55(1): 126–168.
- Skarke, A., C. Ruppel, M. Kodis, D. Brothers, and E. Lobecker. 2014. Widespread methane leakage from the sea floor on the northern US Atlantic margin. *Nature Geoscience* 7:657–661. <http://www.nature.com/ngeo/journal/v7/n9/abs/ngeo2232.html>
- Talling, P., M. Clare, M. Urlaub, E. Pope, J. Hunt, and S. Watt. 2014. Large Submarine Landslides on Continental Slopes: Geohazards, Methane Release, and Climate Change. *Oceanography* 27(2):32-45

Next Generation Science Standards

This lesson supports the Ocean Literacy Essential Principles and Fundamental Concepts as indicated here http://oceanexplorer.noaa.gov/oceanos/edu/collection/media/wdwe_standards.pdf. Additionally, while it is not intended to target specific Next Generation Science Standards, activities in this lesson may be used to address specific elements of the NGSS as described below.

Specific NGSS Performance Expectations relevant to this lesson:

MS-ESS3-5. Ask questions to clarify evidence of the factors that have caused the rise in global temperatures over the past century. [Clarification Statement: Examples of factors include human activities (such as fossil fuel combustion, cement production, and agricultural activity) and natural processes (such as changes in incoming solar radiation or volcanic activity). Examples of evidence can include tables, graphs, and maps of global and regional temperatures, atmospheric levels of gases such as carbon dioxide and methane, and the rates of human activities. Emphasis is on the major role that human activities play in causing the rise in global temperatures.]

HS-ESS2-2. Analyze geoscience data to make the claim that one change to Earth's surface can create feedbacks that cause changes to other Earth systems. [Clarification Statement: Examples should include climate feedbacks, such as how an increase in greenhouse gases causes a rise in global temperatures that melts glacial ice, which reduces the amount of sunlight reflected from Earth's surface, increasing surface temperatures and further reducing the amount of ice. Examples could also be taken from other system interactions, such as how the loss of ground vegetation causes an increase in water runoff and soil erosion; how dammed rivers increase groundwater recharge, decrease sediment transport, and increase coastal erosion; or how the loss of wetlands causes a decrease in local humidity that further reduces the wetland extent.]

Discussion of students' responses to questions of the *Methane Hydrate Investigation Guide* can be guided to address both of these Performance Expectations by focusing on the role of methane as a greenhouse gas, and on processes that may result in methane being released to the atmosphere from methane hydrates. For example, how warmer temperatures in the arctic may reduce snow cover, resulting in a darker terrestrial surface that absorbs more heat.

For Information and Feedback

We value your feedback on this lesson, including how you use it in your formal/informal education settings.

Please send your comments to:
oceaneducation@noaa.gov

Acknowledgments

Produced by Mel Goodwin, PhD, Marine Biologist and Science Writer, Charleston, SC. Design/layout: Coastal Images Graphic Design, Charleston, SC. If reproducing this lesson, please cite NOAA as the source, and provide the following URL:
<http://oceanexplorer.noaa.gov>

Methane hydrate models in progress during a professional development workshop. Image courtesy NOAA.

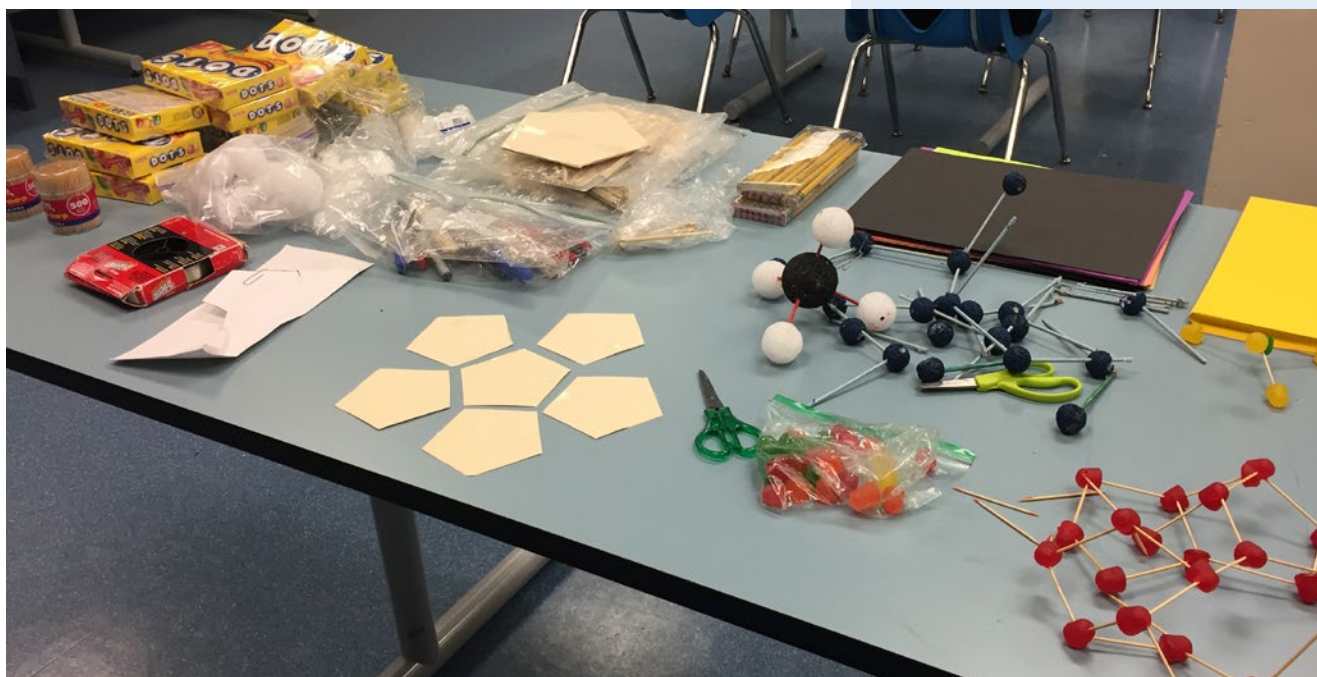



Methane Hydrate Investigation Guide

Research Questions

1. What is a clathrate?
2. What is methane hydrate? Include a model of a methane hydrate with your written report (refer to the *Methane Hydrate Model Construction Guide*).
3. How are methane hydrates formed?
4. Where are methane hydrates found?
5. What is the effect of methane in the atmosphere? Is there any evidence of a direct effect on life on Earth in geological time?
6. In what ways can methane be released from methane hydrates?
7. Is there any practical use for methane hydrates?
8. Do methane hydrates pose any immediate danger to coastal areas?
9. Are any unusual biological organisms or communities associated with methane hydrates? If so, do these communities have any known or potential significance to humans?

Research Tips

1. Try a keyword search using the following terms, alone or in combination:
Cold seeps, Methane hydrate, Clathrate, Methanogenic Archaea, Paleocene extinction, Energy hazard
2. Explore the following Web sites:
<http://oceanexplorer.noaa.gov>

<http://www.netl.doe.gov/technologies/oil-gas/FutureSupply/MethaneHydrates/maincontent.htm>

<https://pubs.usgs.gov/fs/fs021-01/fs021-01.pdf>

Fire ice. Methane hydrates burn and drip water. Image courtesy USGS.

Methane Hydrate Model Construction Guide

Materials

Materials for constructing a methane hydrate model:

For constructing a pentagon:

- Paper, unlined 8-1/2" X 11"
- Pencil
- Protractor or compass

For constructing the dodecahedron half, clathrate cage, methane molecule and methane hydrate model:

- Scissors
- Cardboard or card stock (enough to make 7 pentagons)
- Ruler, 12-inch
- Tape
- Fishing line, or light colored thread
- Toothpicks; 34 per table - 30 blue, 4 red)
- Gumdrop candy (such as "Tootsie Dots"); 20 of one color, 4 of another color, and 1 of a third color, per table

Procedure

Part 1 – Build a pentagonal dodecahedron

1. Draw a pentagon on paper and cut it out. Each side of the pentagon should be 6 cm (2-3/8 inches) long.

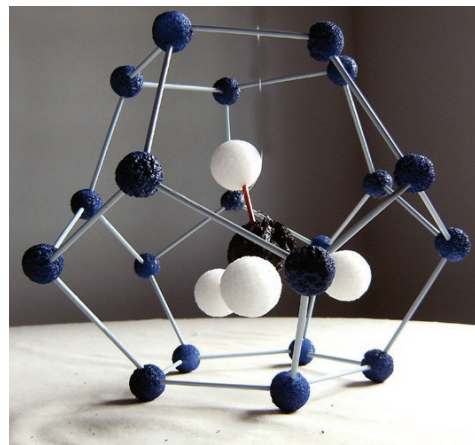
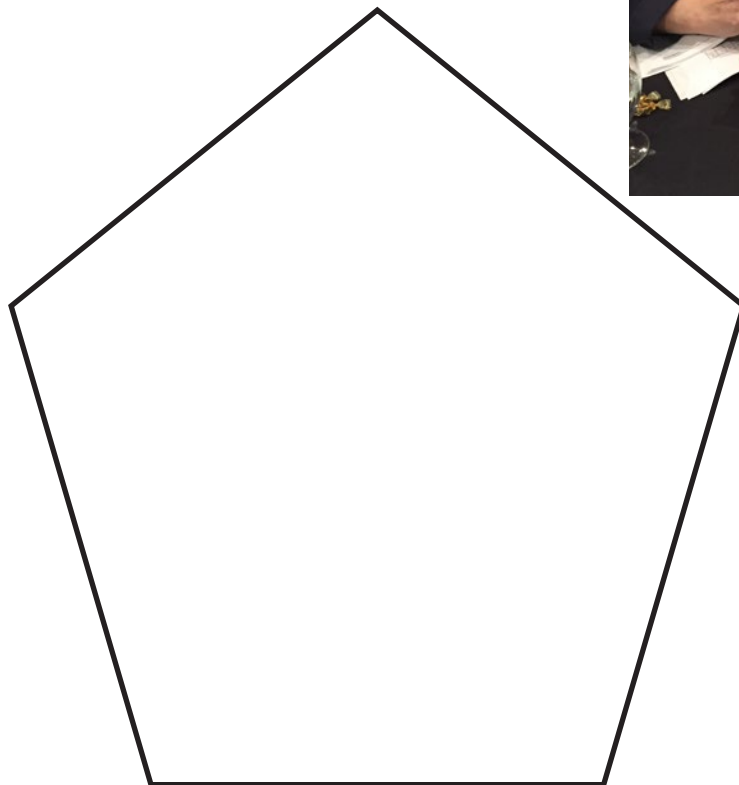

A finished model of a methane hydrate. Image courtesy of Mellie Lewis.



Methane hydrate models in progress during a professional development workshop. Image courtesy NOAA.

Step 2.



2. Trace the paper pentagon onto cardboard or card stock and cut it out. Each group will cut out 7 pentagons (6 for the top half and one for the pattern).

3. Lay one pentagon on a flat surface and surround it with five more pentagons matched side to side. Tape the five outside pentagons to the center pentagon.

4. Carefully pull up one pair of pentagons and tape their common sides together. Repeat until the five pentagons have been taped together, forming a five-sided bowl. This is one half of a pentagonal dodecahedron.

Step 3.



Right: Participants at an *Exploring the Deep Ocean with NOAA* professional development workshop finishing half of a pentagonal dodecahedron.
Below: Sorting the candy dots (Colors may vary according to what kind of dots are available).
Images courtesy NOAA.



Part 2 – Build the Model Molecules

1. Separate candy dots and toothpicks:
 - 20 dots of the same color represent water molecules
 - 4 dots of a second color represent hydrogen atoms
 - 1 dot of a third color represents a carbon atom
 - Blue toothpicks represent hydrogen bonds between water molecules
 - Red toothpicks represent covalent bonds in the methane molecule

Build the clathrate cage:

- Place the 7th pentagon on a flat surface. Place a blue toothpick on one side and two dots representing water molecules at each end. Carefully insert the end of the blue toothpick into the middle of each candy dot. Repeat with three more dots of the same color and four more blue toothpicks to form a candy-and-toothpick pentagon.

Step 2a.



Step 2b.



Step 2c.

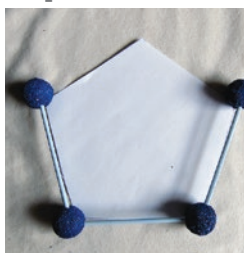

Step 2d.

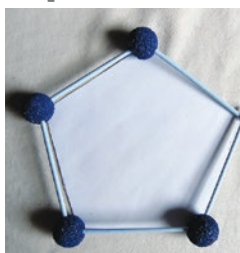

Step 2e.

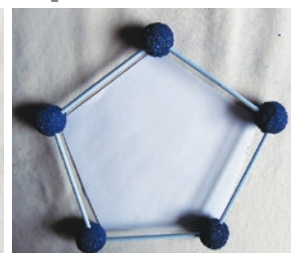

- Place the candy-and-toothpick pentagon in the dodecahedron half—be careful, it will lay approximately an inch up from the bottom. The dodecahedron half (bowl) is used as a template to build the candy and toothpick dodecahedron with the correct toothpick angle.

Step 3.

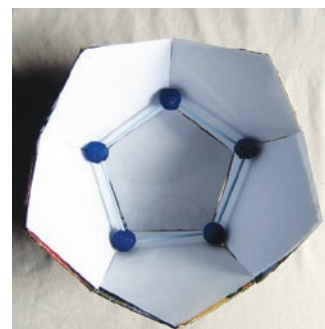

- Place five blue toothpicks inside the center of each dot representing water molecules using the dodecahedron half as a guide for the correct toothpick angle. It's very important to insert the toothpicks into the center of the candy dot at the same angle as the side of the dodecahedron half.

Step 4.



- Insert a candy dot representing water molecules on top of each blue toothpick. Carefully remove the incomplete cage from the bowl and place it on a flat surface.

Step 5.

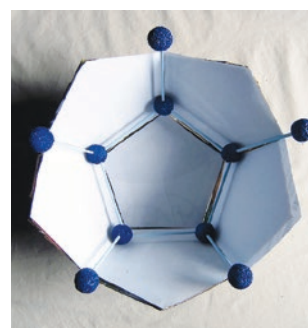

Step 6.

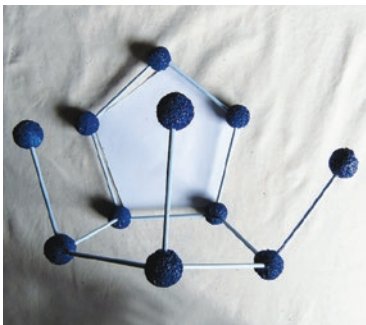

6. Use the 7th pentagon to complete the bottom half of the cage. Turn the candy-and-toothpick model onto one side and, using the pentagon to determine the correct angle, insert a blue toothpick into the center of the two candy dots representing water molecules. Then, attach another candy dot representing a water molecule to connect the two blue toothpicks you've just attached. This makes the second face and second pentagon of the cage. The first face was the bottom.

Step 8.



7. Repeat Step 6 four more times to form the remaining faces for the bottom half of the cage.

8. Repeat Steps 2, 3, and 4 to construct the top half of the cage.

9. Carefully place the bottom half of the cage into the bottom of the cardboard bowl. Attach the two halves of the cage together. Working together with your partners, hold the top half of the cage over the bottom half. The two halves will only fit together one way. Rotate the top half until all of the unattached toothpicks line-up with a candy dot. Insert each blue toothpick into the center of the corresponding candy dot representing a water molecule.

Step 11.

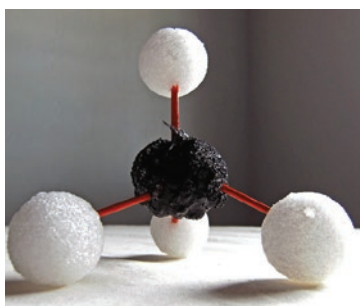

Build the Methane Molecule:

11. Break two red toothpicks in half, and insert the four half-toothpicks into the candy dot representing a carbon atom so that they are evenly spaced (when the model is placed on a flat surface, three of the toothpicks and the dot representing the carbon atom should look like a tripod with the fourth toothpick pointing straight up). Attach a candy dot representing a hydrogen atom to the other end of each of the red half-toothpicks.

Step 12.

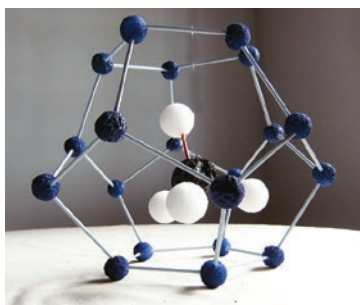

Assemble the Methane Hydrate Model

12. Suspend the methane molecule in the middle of the clathrate cage by attaching fishing line from one of its covalent bonds (red toothpicks) to two opposing hydrogen bonds (blue toothpicks) at the top of the cage. Your Methane Hydrate Model is finished!

All methane hydrate model images courtesy of Mellie Lewis.

Note: Each of the candy dots representing a water molecule consists of two hydrogen atoms and one oxygen atom. To keep the model simple, we don't show all of these atoms separately.

Appendix A

Adapting the Methane Hydrate Model Construction Activity as a Cross-curricular Mathematics Lesson

Learning Objectives

- Students will demonstrate geometric properties through hands on manipulation of geometric shapes.
- Students will be able to construct a pentagonal dodecahedron.
- Students will be able to construct a model of a methane hydrate.

Teaching Time

Three or four 50-minute class periods or may be sent home as an enrichment activity

Definitions

- Polygon – a geometric shape made up of vertices that are connected with line segments
- Vertex – a point where the sides of an angle meet
- Pentagon – a geometric shape with five equal sides and five 108° angles
- Dodecahedron – a three-dimensional geometric shape that has 12 faces (regular pentagons), 20 vertices, and 30 edges

Prerequisite Skills

Students should have basic knowledge of geometric shapes and know how to draw a pentagon. If not, directions for drawing a pentagon using a compass or protractor may be found in middle school mathematics textbooks or in the links below.

Procedure

1. Lead an introductory discussion of how mathematical models help us understand science concepts.
2. Tell students that they will be using concepts and skills they have learned in mathematics class to build a pentagonal dodecahedron, a clathrate cage, and methane hydrate model.
3. Provide students with copies of the Methane Hydrate Construction Guide and required materials.

Resources

http://wiki.answers.com/Q/How_would_you_draw_a_regular_pentagon

Common Core State Standards for Mathematics

High School:

HSG.MG.A.1. Use geometric shapes, their measures, and their properties to describe objects.

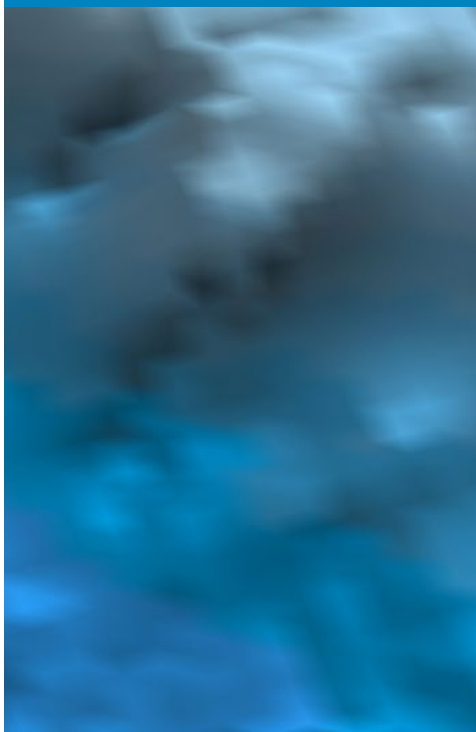

Wet Maps

Focus

Bathymetric mapping

Grade Level

6-8 (Physical Science/Earth Science)

Focus Question

What kinds of maps are used for ocean exploration, and how are these maps made?

Learning Objectives

- Students will explain how multibeam sonar is an example of advances in engineering that have extended the measurement, exploration, modeling, and computational capacity of scientific investigations.
- Students will analyze data from a simulated multibeam sonar system to create a three-dimensional map that shows ocean sea floor ridges and trenches, and explain how tectonic processes produce these features.

Materials

For each student group:

- Copies of *Multibeam Mapping Simulation Activity Guide* and *Multibeam Mapping Simulation Activity Preparation Guide* (if you decide to have the students do the preparation)
- Cardboard or plastic box with lid, approximately 10 x 10 x 6 inches (at least 6 inches deep)
- Pencils, unsharpened; or wood dowels approximately 1/4-inch diameter x 8 inches; two for each student
- Copies of Sounding Rod Scale (Figure 2); two for each student
- Clear tape
- Plaster of Paris, 1 – 2 lb, or plaster wrapcloth (from craft stores); or pieces of styrofoam
- Masking tape
- Colored pencils, six colors

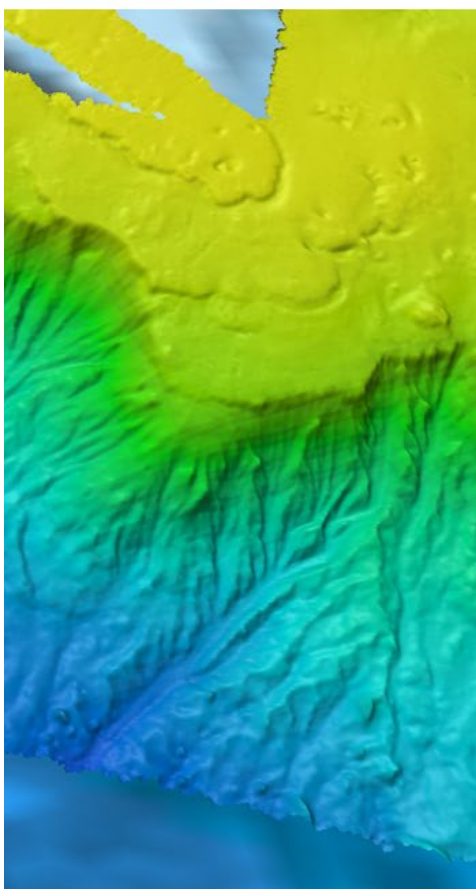

Comparison of resolution of satellite-derived bathymetry (top) and multibeam sonar bathymetry collected by the *Okeanos Explorer* (bottom). Example shown is the largest seamount in the Wake Atoll Unit of the Pacific Remote Islands Marine National Monument. Image courtesy of NOAA OER.

<http://oceanexplorer.noaa.gov/okeanos/one-million/media/sat-bathy.html>

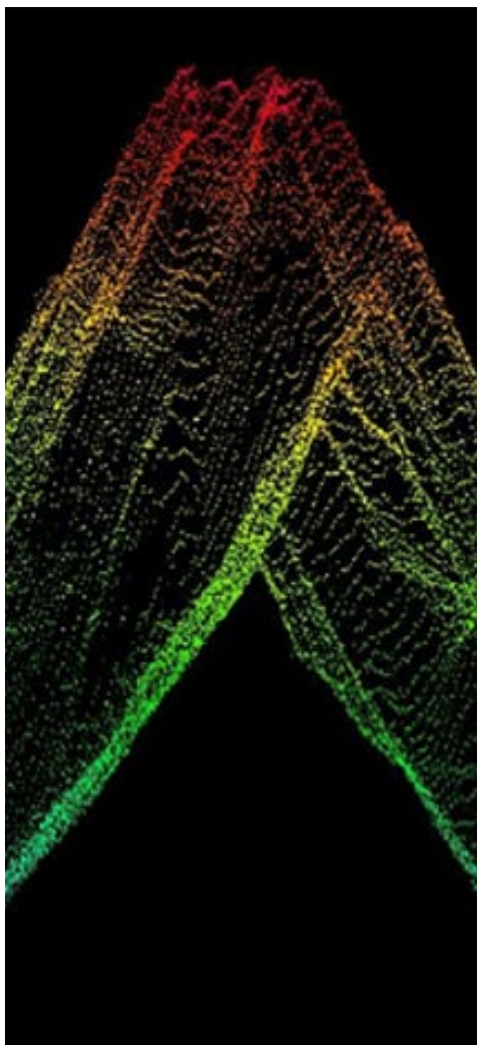

Raw multibeam sonar data of an underwater mountain visualized in 3D computer software. Image courtesy NOAA OER, Discovering the Deep: Exploring Remote Pacific MPAs.
<http://oceanexplorer.noaa.gov/oceanos/explorations/ex1703/logs/mar11/media/raw-sonar.html>

- Ruler, one for each student group
- Graph paper

Audiovisual Materials

Optional – Images of exploration technologies and animations (see Learning Procedure, Step 1c)

Teaching Time

Three to four 45-minute class periods, depending upon the availability of resources and activities assigned for out-of-class completion

Seating Arrangement

Groups of three to four students

Maximum Number of Students

30

Key Words and Concepts

Ocean Exploration
Okeanos Explorer
Bathymetric map
Multibeam sonar

Background Information

Multibeam sonar is one of the most powerful tools available for modern deep-sea exploration, and can create high-resolution maps, three dimensional models, or even “fly-through” videos that simulate a trip across the area being mapped.

For more information about how multibeam sonar is used aboard the NOAA Ship *Okeanos Explorer*, see the *Introduction to Sonar and Multibeam Mapping* <http://oceanexplorer.noaa.gov/oceanos/edu/collection/media/hdwe-MMBkgnd.pdf>. In this lesson, students will learn about multibeam sonar, and use mock sonar set-ups to create a three-dimensional model of a simulated ocean floor.

Learning Procedure

1. To prepare for this lesson:
 - a) Review:
 - Ocean Mapping: an Essential Part of Ocean Exploration by Derek Sowers, Charles Wilkins, and Jason Meyer <http://oceanexplorer.noaa.gov/oceanos/explorations/ex1703/logs/mar11/welcome.html>;
 - NOAA Ship *Okeanos Explorer*: One Million Square Kilometers of Seafloor Mapped <http://oceanexplorer.noaa.gov/oceanos/one-million/welcome.html>;
 - Seafloor Mapping <https://schmidtocean.org/technology/seafloor-mapping/> and
 - Minding the Multibeam at Midnight by Colleen Peters <http://oceanexplorer.noaa.gov/oceanos/explorations/10index/logs/aug05/aug05.html>

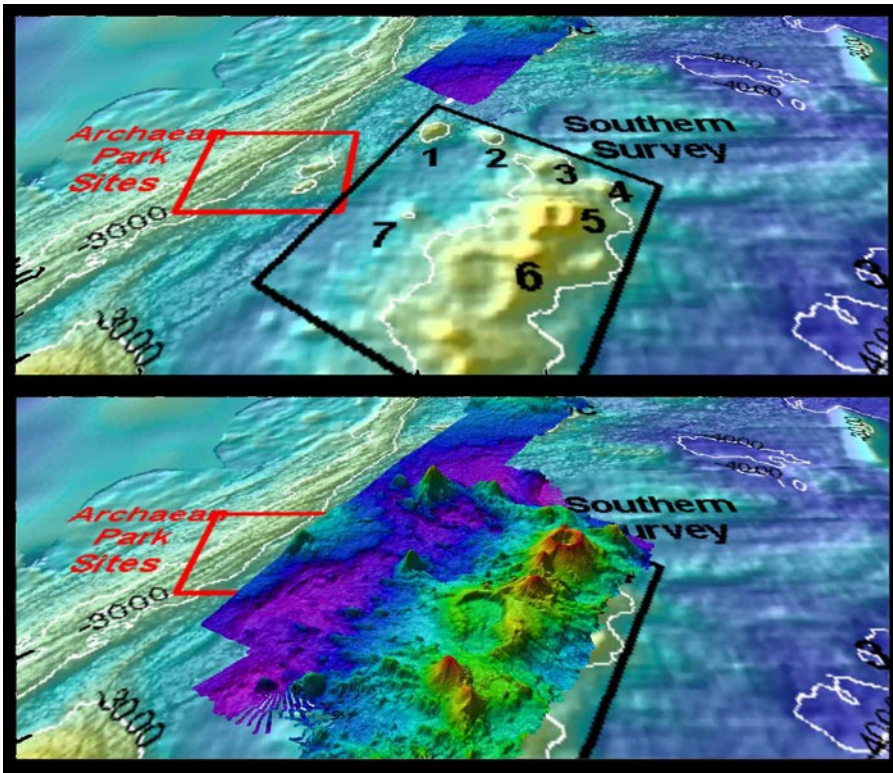

This “before and after” image provides a glimpse of *Okeanos Explorer’s* EM302 mapping system capabilities in deep water. The top image shows what we previously knew about the seafloor terrain in the southern Mariana region from satellite altimetry data. The bottom image includes an overlay of the information provided by the ship’s EM302 multibeam system. Image courtesy of NOAA OER. http://oceanexplorer.noaa.gov/oceanos/explorations/10index/background/hires/em302_before_after_hires.jpg

- b) Review the *Introduction to Ships of Exploration and Their Strategy for Ocean Exploration* <http://oceanexplorer.noaa.gov/oceanos/edu/collection/media/hdwe-StrategyBkgnd.pdf>.
- c) If desired, download images to accompany discussions in Step 2. You may also want to download these “before and after” images to illustrate the capabilities of multibeam sonar:
http://oceanexplorer.noaa.gov/oceanos/explorations/10index/background/hires/em302_before_after_hires.jpg
<http://oceanexplorer.noaa.gov/edu/images/WetMapsImageRev.jpg>

The image below is from a multibeam sonar survey in the Pacific Remote Islands Marine National Monument that shows an approximately 1,700 meter seamount height difference when compared to previous satellite altimetry.

This image, from a multibeam sonar survey in the Pacific Remote Islands Marine National Monument, shows an approximately 1,700 meter seamount height difference when compared to previous satellite altimetry. <http://oceanexplorer.noaa.gov/edu/images/WetMapsImageRev.jpg>

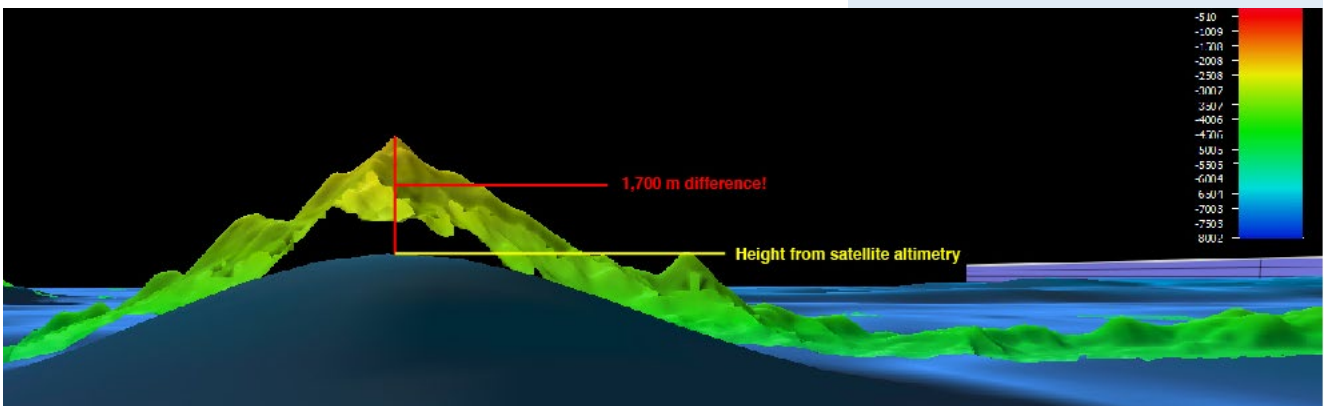

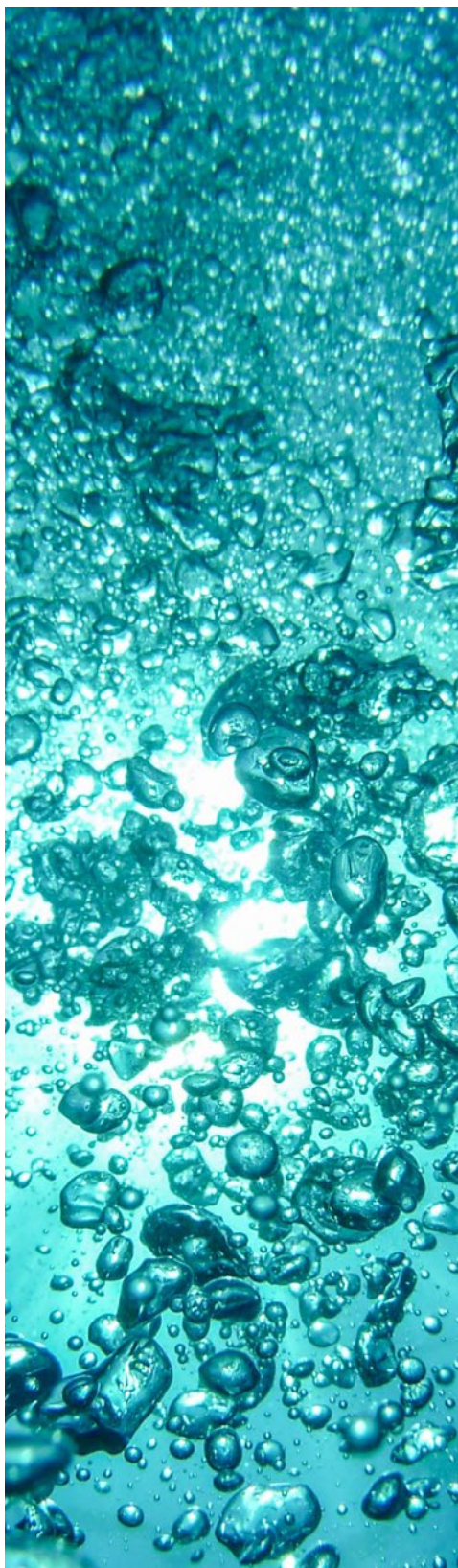

Multibeam sonar imagery shows a plume of bubbles rising from the crater of the Vailulu'u Seamount near American Samoa. Image courtesy of NOAA OER, 2017 American Samoa Expedition. <http://oceanexplorer.noaa.gov/oceanos/explorations/ex1702/logs/feb22/media/vailulu2.html>



The NOAA Ship *Okeanos Explorer*, America's ship for ocean exploration. Image courtesy NOAA. <http://oceanexplorer.noaa.gov/oceanos/explorations/ex1702/logs/mar1/media/oceanos.html>

This is a great example of why it is important to map the seafloor using modern, high-resolution sonar systems. This video may be useful to accompany discussions in Step 3: http://oceanexplorer.noaa.gov/oceanos/media/movies/ex_podcast_video.html

- d) Review the *Multibeam Mapping Simulation Activity Guide* and *Multibeam Mapping Simulation Activity Preparation Guide*, and decide how much preparation will be done by students. This activity may be varied, according to time available and individual teaching and learning styles. For example, students may be divided into "Beam Teams," each of which constructs a mystery landscape that is kept hidden from other teams. Teams then exchange boxes and perform the mapping procedure to reveal the "mystery topography." This can become a competition between teams if points are awarded to teams that accurately predict the topography in the shortest amount of time.

- 2. Briefly introduce the ships of exploration NOAA Ship *Okeanos Explorer*, E/V *Nautilus*, and R/V *Falkor*; the *Introduction to Ships of Exploration and Their Strategy for Ocean Exploration* <http://oceanexplorer.noaa.gov/oceanos/edu/collection/media/hdwe-StrategyBkgnd.pdf>; and the 2017 Discovering the Deep: Exploring Remote Pacific MPAs Expedition <http://oceanexplorer.noaa.gov/oceanos/explorations/ex1703/background/plan/welcome.html>.

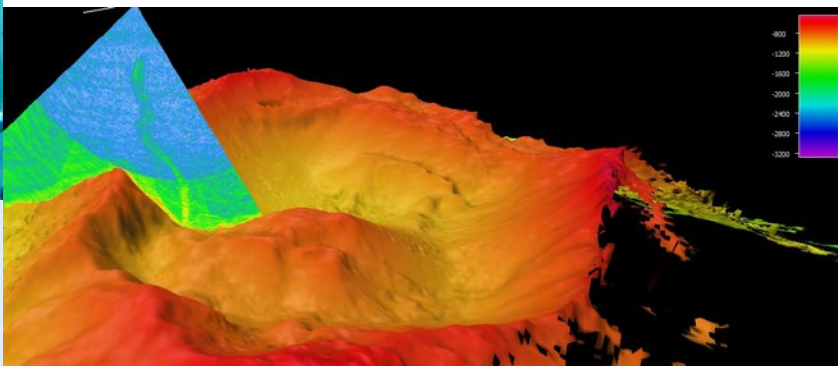

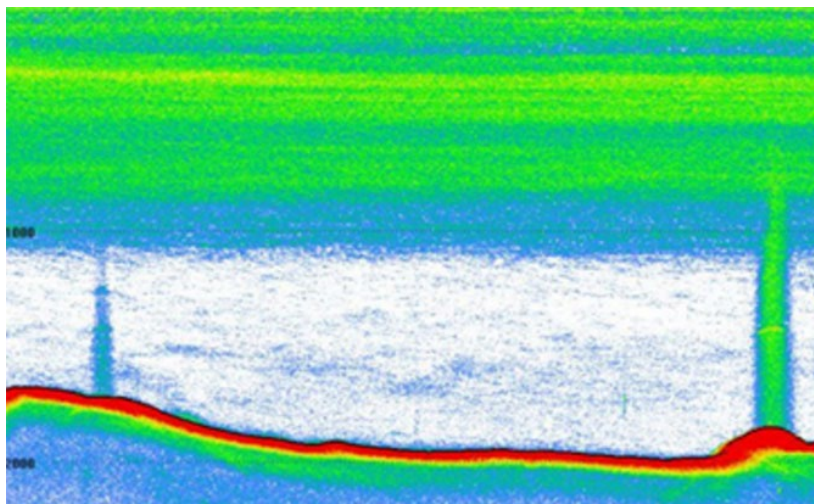

Briefly discuss why this kind of exploration is important (for background information, please see the lesson *To Boldly Go* http://oceanexplorer.noaa.gov/oceanos/edu/collection/media/wdwe_toboldlygo.pdf). Highlight the overall exploration strategy used by ships of exploration, including the following points:

- The overall strategy is to develop baseline information about the biological, geological, and water chemistry features of unexplored areas to provide a foundation for future exploration and research.
- This information includes
 - High resolution maps of the area being explored, as well as areas that the ship crosses while underway from one location to the next (underway reconnaissance)
 - Exploration of water column chemistry and other features
 - High definition close-up video of biological and geological features in the exploration area (site characterization)
- This strategy relies on four key technologies:
 - Multibeam sonar mapping system and other types of sonar that can detect specific features in the water column and on the seafloor;
 - Conductivity, Temperature, and Depth profilers (CTD) and other electronic sensors to measure chemical and physical seawater properties;
 - A Remotely Operated Vehicle (ROV) capable of obtaining high-quality imagery and samples in depths as great as 6,000 meters; and
 - Telepresence technologies that allow scientists with many different areas of expertise to observe and interact with exploration activities, though they may be thousands of miles from the ship.

Sometimes form wins—*Deep Discoverer* (D2) is an elegant and powerful 9,000 pounds, designed to bring optimal imagery topside, where it is then shipped to shore in real time. Image courtesy of NOAA OER, Gulf of Mexico 2014 Expedition.

<http://oceanexplorer.noaa.gov/oceanos/explorations/ex1402/logs/apr15/media/drfront.html>

(Left): Example image of echogram from EK60 fisheries sonar. The red feature is the seafloor. Green and blue areas in the water column are features with high backscatter. The lines near the surface show dense layers of biology (zooplankton, fish, gelatinous creatures, etc.), while the vertical lines are bubble plumes emanating from the seafloor. Image courtesy of NOAA OER, *Discovering the Deep: Exploring Remote Pacific MPAs*.

<http://oceanexplorer.noaa.gov/oceanos/explorations/ex1703/logs/mar11/media/echogram.html>



Scientist Scott France participates in the dives from his home office via telepresence. Image courtesy of NOAA OER, 2016 Deepwater Exploration of the Marianas.

<http://oceanexplorer.noaa.gov/oceanos/explorations/ex1605/logs/jun28/media/1605scott-france.html>

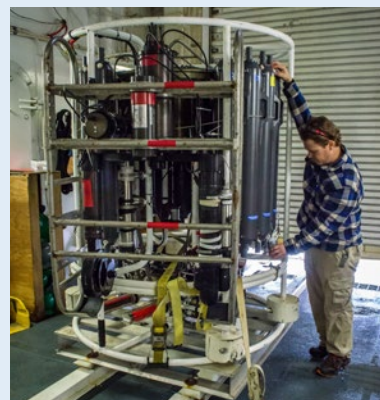

Water samples are collected from the Niskin bottles on a Conductivity, Temperature and Depth profiler (CTD). All 20 Niskin bottles take water samples from various depths, starting near the seafloor and ending close to the surface. Photo courtesy of Caitlin Bailey, GFOE, *The Hidden Ocean 2016: Chukchi Borderlands*. <http://oceanexplorer.noaa.gov/explorations/16arctic/logs/july24/media/shipton.html>



Exploring the Deep Ocean with NOAA

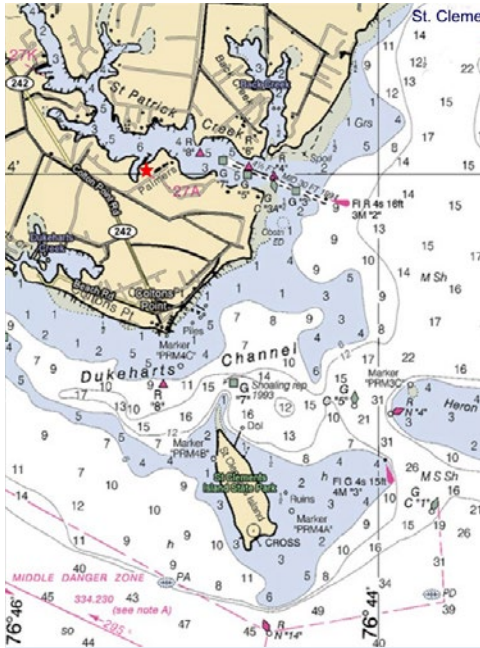

Nautical charts based on data collected with lead lines often consist of many small numbers scattered over the chart that correspond to the measured depth at the locations represented on the chart. Image courtesy NOAA.

Different types of sonar: Lead line, Single beam and Multibeam. Adapted from the Canadian Hydrographic Service. <https://noaacostsurvey.files.wordpress.com/2015/07/surveying.jpg>

3. Ask students what they know about sonar, and provide additional information as necessary. (See the *Introduction to Sonar and Multibeam Mapping* <http://oceanexplorer.noaa.gov/oceanos/edu/collection/media/hdwe-MMBkgnd.pdf>). You may want to show the video clip referenced in Step 1c.

Ask students how scientists and mariners made maps of underwater features before sonar was invented. For centuries, depth measurements were made with lead lines. A lead line is a rope or line with a 10-pound lead weight attached to the end. To make a depth measurement, the line is lowered into the water until the weight reaches the bottom. Markings on the line show how much line has been let out, which is equal to the depth of the water. Depth soundings made with lead lines are accurate, but they take a lot of time and only give information about single points of the sea bottom—so many lead line measurements are needed to accurately survey a given area.

Nautical charts based on data collected with lead lines often consist of many small numbers scattered over the chart that correspond to the measured depth at the locations represented on the chart. The invention of single beam sonar made it possible to collect many more data points, and this allowed scientists to construct bathymetric charts, which are similar to topographic maps that show the contour of landforms. Bathymetric charts, however, show the contour of the ocean floor. While they are a great improvement over charts made with lead line data, bathymetric charts are still two-dimensional representations of three-dimensional features and it takes practice to be able to accurately interpret these charts.

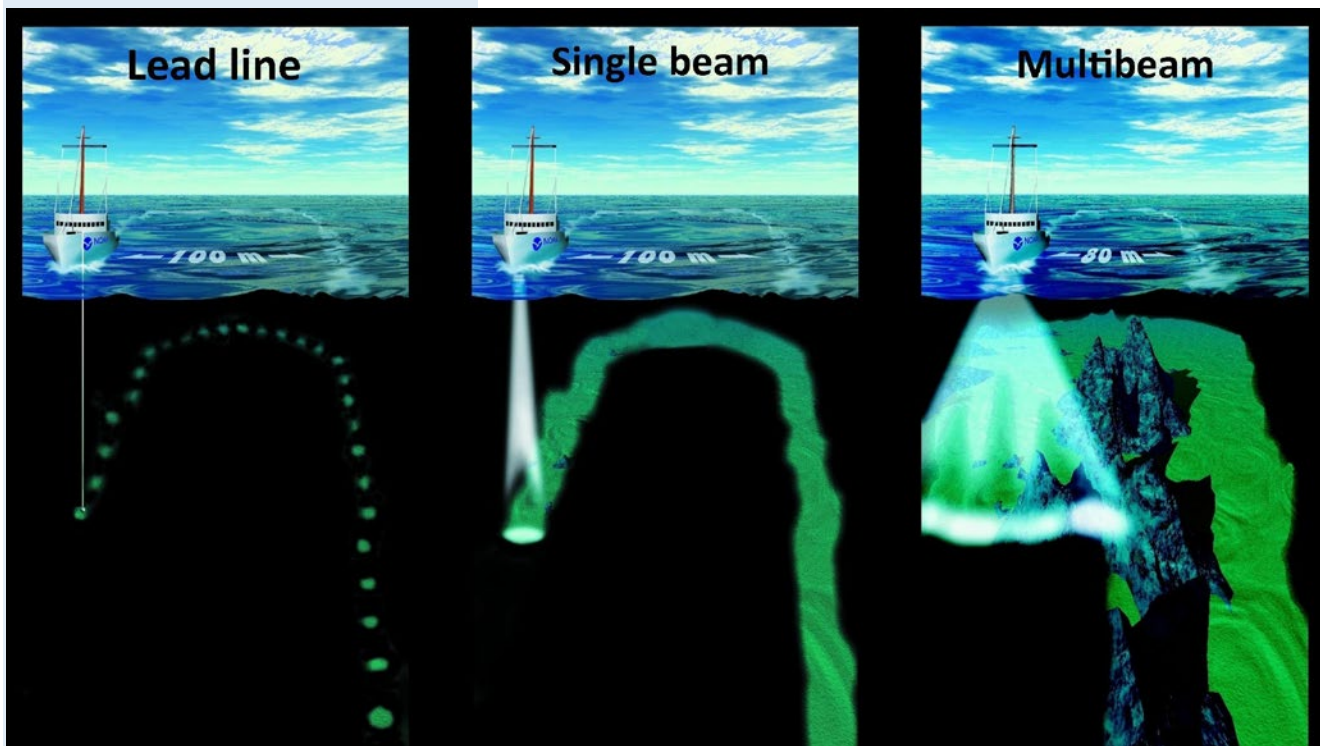

The development of multibeam sonar technology makes it possible to produce very detailed images of seafloor features, and to show the three-dimensional characteristics of these features. Point out that this is an example of how advances in engineering have extended the measurement, exploration, modeling, and computational capacity of scientific investigations.

Describe the role of multibeam sonar in ocean exploration aboard the *Okeanos Explorer*. Students should realize that this is the key technology for the “reconnaissance” component of the overall exploration strategy, and provides the “big picture” view as explorers look for anomalies. You may wish to have students read the log entry “Minding the Multibeam at Midnight” (Step 1a). These images shows how much *Okeanos Explorer*’s EM302 mapping system adds to what we know about seafloor terrain:

http://oceanexplorer.noaa.gov/okeanos/explorations/10index/background/hires/em302_before_after_hires.jpg.

<http://oceanexplorer.noaa.gov/edu/images/WetMapsImageRev.jpg>

- Tell students that their assignment is to map an unexplored and invisible landscape using methods that roughly simulate multibeam sonar technology. Divide students into “Beam Teams” of three or four students, and provide each team with a copy of the *Multibeam Mapping Simulation Activity*, and access to necessary materials. Tell students that oceanographers like to graph depth so that the greatest depths are near the bottom of the graph, because this is how we imagine a vertical slice of the ocean would appear. So, the Y-axis on the bar graphs is made so that the largest depth values will be at the bottom of the graphs. You may want to have students color the depth contours on their graphs after they are cut out using the color scheme on the Sounding Rods (or any other scheme that you choose). Coloring the cutouts will make the final model more closely resemble a multibeam sonar image.

When students have completed their 3-D bathymetry models, have each group show their models to the entire class, report their conclusions about the mystery landscape and what they infer about tectonic processes that might have produced this landscape. After each group has reported their conclusions, have them open their box, and compare the actual topography with their predictions.

- When all groups have made their presentations, ask students how their



Mapping personnel on the Discovering the Deep: Exploring Remote Pacific MPAs expedition (L to R): Mapping Lead Derek Sowers, Watch Lead Jason Meyer, and Survey Technician Charles Wilkins. Image courtesy of NOAA OER, Discovering the Deep: Exploring Remote Pacific MPAs.

<http://oceanexplorer.noaa.gov/okeanos/explorations/ex1703/logs/mar11/welcome.html>

Typical night time mapping watch in the control room. Back to front: Senior Survey Technician Elaine Stuart monitors incoming data and adjusts settings as necessary; ROV team member, Tom Kok, does double duty by processing mapping data as it is collected; Major Dian Adrianto provides hourly status updates about ship operations to shore via intercom and the Eventlog. Image courtesy of NOAA OER, INDEX-SATAL 2010.

http://oceanexplorer.noaa.gov/okeanos/explorations/10index/logs/aug05/media/night_watch.html



Exploring the Deep Ocean with NOAA

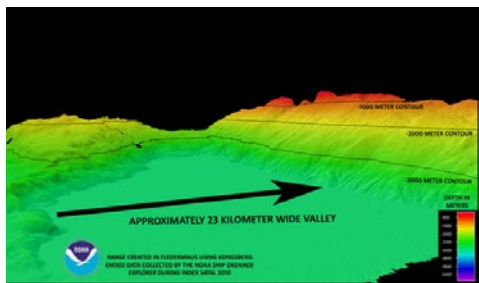

The EM302 gives us a high resolution “bird’s eye” view of large areas. What we see underwater is similar to what we see around us every day. In the above image, a panorama of mountains and volcanoes sit majestically near a massive river delta surrounded by a soft sand beach. Since what we see here is actually underwater, there are, of course, no rivers or river deltas, or mountains and sand bars. Image courtesy of NOAA OER, INDEX-SATAL 2010. http://oceanexplorer.noaa.gov/oceanos/explorations/10index/logs/july31/media/seamount_channels.html



Picture of the EK60 split-beam transducer mounted on the hull of the *Okeanos Explorer*. Image courtesy of NOAA Office of Ocean Exploration and Research. <http://oceanexplorer.noaa.gov/oceanos/explorations/ex1503/logs/jun6/media/ek60.html>

Multibeam Sonar Systems Aboard the *Okeanos Explorer*

Okeanos Explorer carries a Kongsberg Maritime EM302 deepwater multibeam sonar system. Transducers for the system are installed on the ship’s hull in a custom-designed housing. The system can transmit up to 288 beams, can collect as many as 864 depth measurements in a single ping, and automatically compensates for movements of the ship. The EM302 operates in depths ranging between 10 m and 7,000 m. The width of the swath is about 5.5 times the depth, to a maximum of about 8 km. Depth resolution of the system is 1 cm. At a depth of 4,000 m, the system can resolve features with a dimension of approximately 50 m.

Software packages used to process data from the EM302 and to integrate these data with GPS information about geographic position and sensor data about ship movements include:

- Seafloor Information System
- CARIS
- Fledermaus
- arcGIS
- SonarWiz
- Hypack
- MapInfo

investigations could be improved. Shortening the interval between “soundings” would improve detail in the models; but would also mean a lot more work since an additional graph cutout would have to be made for each row added to the sampling procedure. Having smaller graduations on the sounding rods would help improve the accuracy of “depth” measurements. This accuracy would also be improved by having a way to ensure that the sounding rods are exactly vertical when soundings are made.

Students should realize that a multibeam sonar system would provide an almost continuous record of depth in a swath on either side of the ship. The *Okeanos Explorer*’s multibeam system typically produces swath widths that are three to five times the water depth. Students should also realize that rough topography can obscure other topographic features, so better resolution is especially important when there are boulders, reefs, or other irregular objects in a search area.

Discuss how the ability to accurately map geologic features might help forecast the locations and likelihoods of natural hazards such as volcanic eruptions, tsunamis, and earthquakes (see <http://oceanexplorer.noaa.gov/oceanos/explorations/ex1702/logs/feb20/welcome.html> for an example).

The BRIDGE Connection

www.vims.edu/bridge/ – Scroll over “Ocean Science Topics” in the menu on the left side of the page, then “Human Activities,” then click on “Technology” for activities and links about satellite communications and other ocean exploration technologies.

The “Me” Connection

Have students write a short essay describing a situation (real or imaginary) in which the accuracy of a map was personally important.

Connections to Other Subjects

English Language Arts, Mathematics, Social Studies

Assessment

Class discussions and students’ work with the mapping simulation activity provide opportunities for assessment

Multimedia Discovery Missions

<http://www.oceanexplorer.noaa.gov/edu/learning/welcome.html>
Click on the links to Lessons 5 and 6 for interactive multimedia presentations and Learning Activities on Chemosynthesis and Hydrothermal Vent Life, and Deep-Sea Benthos.

Other Relevant Lessons from NOAA OER

Sound Pictures

<http://oceanexplorer.noaa.gov/explorations/10sanandreas/background/edu/media/soundpics912.pdf>

Focus: Sonar (Grades 9-12; Physical Science)

Students explain the concept of sonar, describe the major components of a sonar system; explain how multibeam and side-scan sonar systems are useful to ocean explorers; and simulate sonar operation using a motion detector and a graphing calculator.

Next Generation Science Standards and Ocean Literacy Essential Principles and Fundamental Concepts

This lesson supports the Ocean Literacy Essential Principles and Fundamental Concepts as indicated here <http://oceanexplorer.noaa.gov/oceanos/edu/collection/media/hdwe-Standards.pdf>. Additionally, while this lesson does not target specific Next Generation Science Standards, educators may use multibeam sonar as a topic for other activities that address the following Performance Expectations.

Specific NGSS Performance Expectation relevant to this lesson is:

MS-PS4-2. Develop and use a model to describe that waves are reflected, absorbed, or transmitted through various materials. [Clarification Statement: Emphasis is on both light and mechanical waves. Examples of models could include drawings, simulations, and written descriptions.] [Assessment Boundary: Assessment is limited to qualitative applications pertaining to light and mechanical waves.]

HS-PS4-1. Use mathematical representations to support a claim regarding relationships among the frequency, wavelength, and speed of waves traveling in various media. [Clarification Statement: Examples of data could include electromagnetic radiation traveling in a vacuum and glass, sound waves traveling through air and water, and seismic waves traveling through the Earth.] [Assessment Boundary: Assessment is limited to algebraic relationships and describing those relationships qualitatively.]

For Information and Feedback

We value your feedback on this lesson, including how you use it in your formal/informal education settings.

Please send your comments to:
oceanexeducation@noaa.gov

Acknowledgments

Produced by Mel Goodwin, PhD, Marine Biologist and Science Writer, Charleston, SC. Design/layout: Coastal Images Graphic Design, Charleston, SC. If reproducing this lesson, please cite NOAA as the source, and provide the following URL:
<http://oceanexplorer.noaa.gov>



The Next Generation Science Standards

The Next Generation Science Standards integrate three dimensions within each standard: Science and Engineering Practices, Disciplinary Core Ideas, and Crosscutting Concepts. The standards are written as student performance expectations. While specific performance expectations may emphasize only a few of the practice categories, teachers are encouraged to utilize several practices in any instruction. Similarly, only a few crosscutting concepts may be emphasized, but this is not intended to limit instruction.

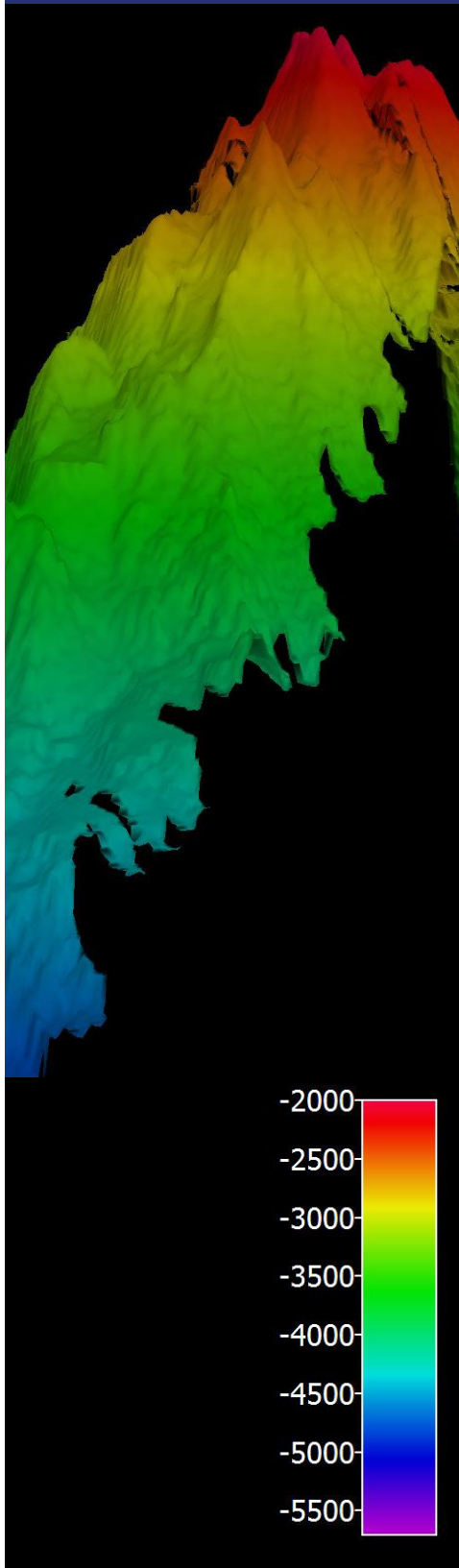

Multibeam Mapping Simulation Activity Preparation Guide

Materials

Each student group will need (assuming four students per group):

1- Cardboard or plastic box with lid, approximately 10 x 10 x 6 inches

8 - Pencils, unsharpened; or wood dowels approximately 1/4-inch diameter x 8 inches; two for each student

1 - Copy of Sounding Rod Scale (Figure 2); two for each student

Clear tape

Plaster of Paris, 1 – 2 lb, or plaster wrap cloth (from craft stores), or pieces of styrofoam

Masking tape

Colored pencils, six colors

Ruler

Graph paper, at least ten sheets

Awl, icepick or sharp nail

Procedure

1. If cardboard boxes of an appropriate size are not available, they can be constructed from poster board using Figure 1 as a guide. Fold along the dotted lines and tape the corners with masking tape.
2. Mark a grid of 1-inch squares on the top of the box. Make a hole at each junction point large enough so that the pencil or dowel can easily be inserted. TIP. Make a hole in the cardboard with an awl, icepick or nail; then enlarge the hole with a sharpened pencil or dowel. Label each row of holes with a number, and each column of holes with a letter (see Figure 1).
3. Cut out the Sounding Rod Scales, so that each student has two scales. If you are using the uncolored scales, color each interval with a colored pencil using the colored scales as a guide. Tape each scale onto a pencil or dowel to make two Sounding Rods for each student. The bottom of the scale should be even with one end of the pencil or dowel.
4. Prepare a “mystery landscape” in the bottom of each box that includes either an ocean ridge or trench. If students are

Seamount mapped on a 2017 return voyage to Honolulu. This “Mountain in the Deep” rose approximately 3,000 meters (9,840 feet) from the seafloor. Image courtesy of the NOAA OER, Mountains in the Deep: Exploring the Central Pacific Basin 2017.

<http://oceanexplorer.noaa.gov/oceanos/explorations/ex1705/dailyupdates/media/may17-1.html>

doing this step, they should keep their work out of the sight of other groups. Mix plaster of Paris, and pour a 1 – 2 cm thick layer into the bottom of each box. You may use plaster wrap cloth instead of Plaster of Paris. You can also use crumpled newspaper or other filler to form your landscape before covering with plaster or wrap cloth. This will reduce the amount of plaster or wrap cloth needed. You may also use pieces of styrofoam to form your landscape, with or without a plaster covering. Do not completely cover the bottom of the box, because that will reduce the overall depth range, and we want a lot of variation in these landscapes! Allow plaster to harden. Temporarily fasten the lids to the boxes with masking tape.

Figure 1. Box Preparation

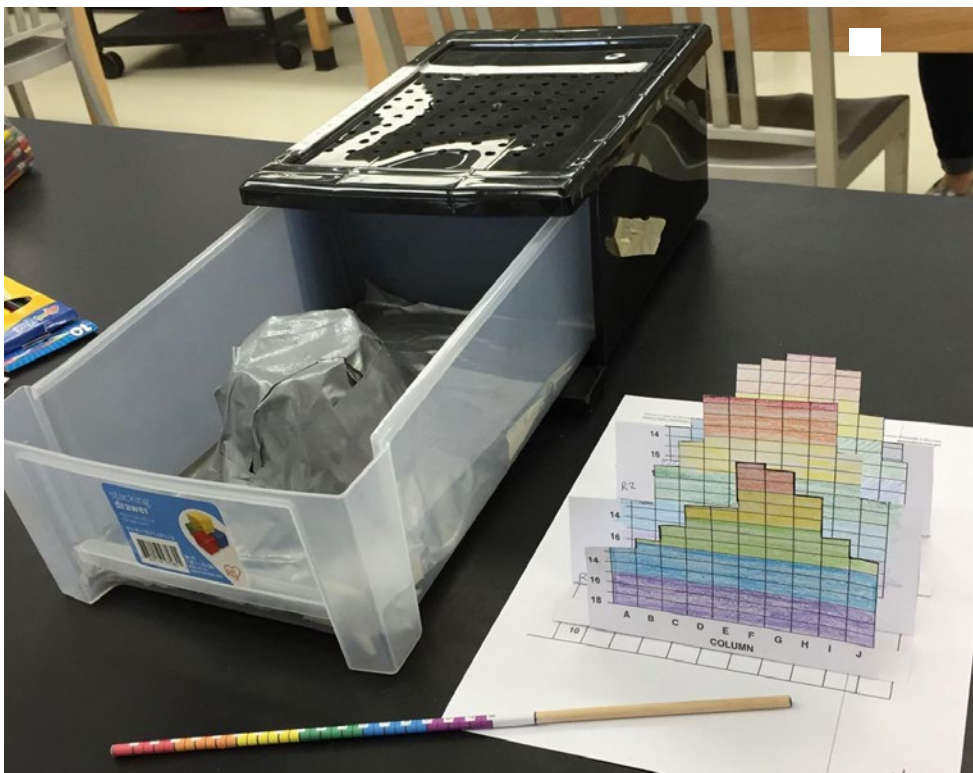
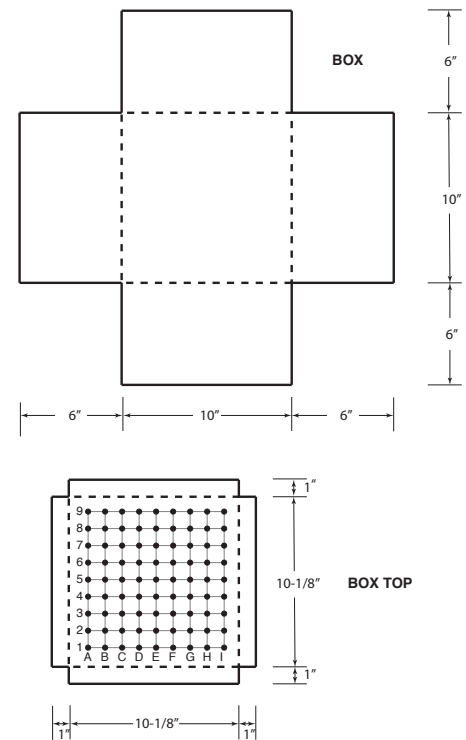

Holes made in plastic box lid; "mystery landscape" in the bottom of the box; dowel taped with colored sounding rod scale; reproduced "landscape" model. Image courtesy NOAA OER.



Figure 2. Sounding Rod Scale

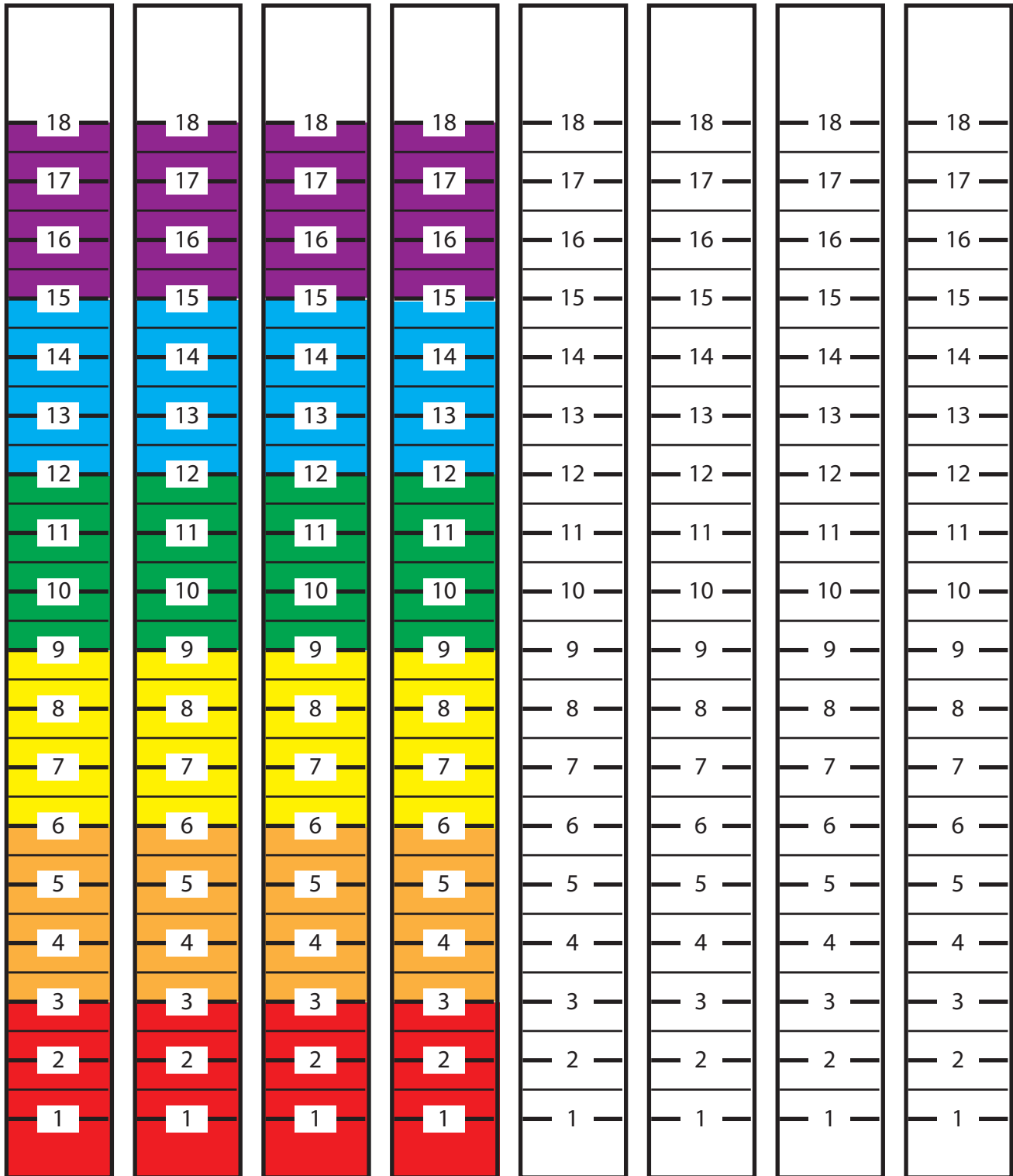

Multibeam Mapping Simulation Activity Guide

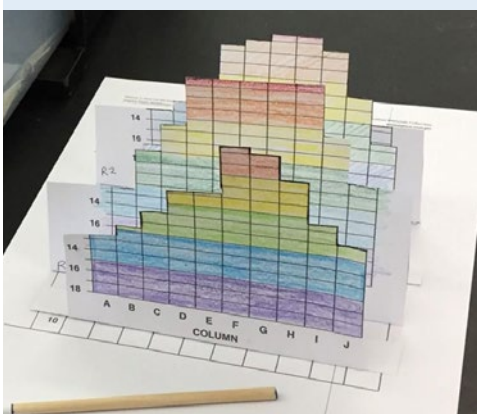

Images of the Wet Maps activity from a Professional Development Workshop. Images courtesy NOAA.

1. Your Beam Team should include three or four students, and each student should have two Sounding Rods. You will use these Rods to measure the depth under each of the holes in the lid of your box, then you will plot these depths to create a three-dimensional model of the landscape hidden inside the box. Each student will be responsible for measuring the depth of two or three of the holes in each row. Do one row at a time, simulating a swath. If you stand in a circle (or part of a circle) around the box, you should all be able to make your measurements at the same time.
2. When your teacher tells you to begin, each member of your team should measure the depth in their assigned holes in the first row using a Sounding Rod. Leave the Rods in place until you have recorded your measurements on the Multibeam Mapping Simulation Data Sheet (Figure 3). It will probably be easiest if one team member does the recording while the other members call out the depth measurements.
3. When you have finished measuring the depths in the first row, use the same procedure to measure depths of the remaining holes, recording the data from your measurements one row at a time.
4. When you have measured all of the depths, and entered all the values, plot the results for each row on a copy of the blank data sheet (Figure 5). Use one copy of the data sheet for each row. Figure 4 shows an example of the graph that resulted from plotting one row of depth data. It will probably be quickest if each team member is responsible for plotting specific rows of data.
5. When your graphs are completed, cut them out as shown in Figure 4. Be sure to leave the border at the bottom of each graph! Fold as shown, and tape each graph onto the top of the box so that the folded edge of each graph lies on its corresponding row on the box top. Stand the graphs up so that they are perpendicular to the top of the box (additional tape may be needed to keep the graphs upright).

Now you should have a three-dimensional model of the mystery landscape inside the box (see photo at left). Wait for further instructions from your teacher.



Figure 3. Multibeam Mapping Simulation Data Sheet

		COLUMNS									
		A	B	C	D	E	F	G	H	I	J
ROWS	1										
	2										
	3										
	4										
	5										
	6										
	7										
	8										
	9										
	10										

Figure 4. Example of graph of data from Row 1.

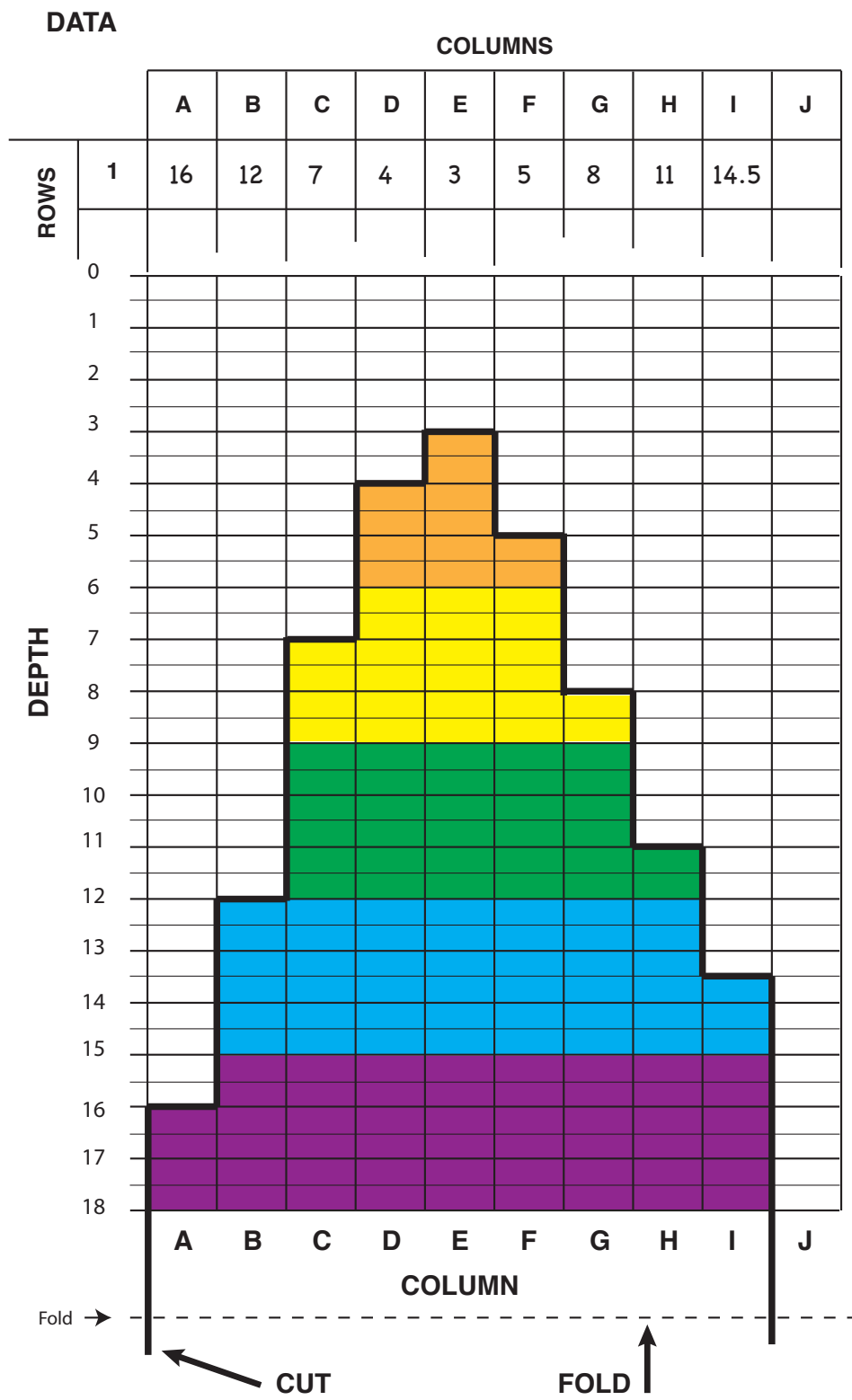
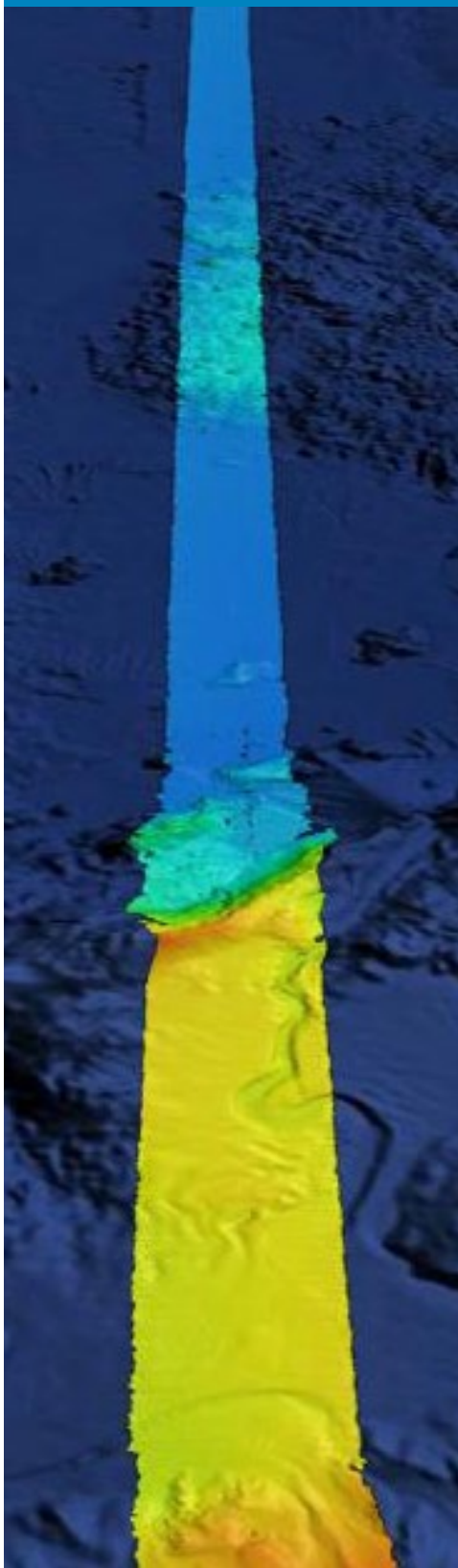

Figure 5. Blank data sheet. Use one data sheet for each row in the box.

		DATA COLUMNS											
		A	B	C	D	E	F	G	H	I	J		
DEPTH	ROW												
	0												
	1												
	2												
	3												
	4												
	5												
	6												
	7												
	8												
	9												
	10												
	11												
	12												
	13												
	14												
	15												
	16												
	17												
18													

Fold → -----



Watching in 3D

Focus

Multibeam sonar

Grade Level

9-12 (Physical Science/Earth Science); also see note concerning grades 6-8 Earth Science under *Next Generation Science Standards and Ocean Literacy Essential Principles and Fundamental Concepts*

Focus Question

How is multibeam sonar used to explore Earth's deep ocean?

Learning Objectives

- Students will explain how multibeam sonar uses the properties of sound waves in water for scientific research about the shape and composition of the ocean floor (bathymetry).
- Students will analyze and interpret multibeam sonar data to identify patterns in the distribution of seafloor features that contribute to scientific research about large-scale interactions in Earth's systems.

Materials

- Copies of the *Sonar Background Review Worksheet*, one copy for each student
- Copies of the *Introduction to Multibeam Imagery Worksheet*, one copy for each student group

Audiovisual Materials

- Video projector or large screen monitor for showing downloaded images (see Learning Procedure, Step 3)

Teaching Time

Two or three 45-minute class periods

Seating Arrangement

Groups of three to four students

The NOAA Office of Ocean Exploration and Research pursues every opportunity to map, sample, explore, and survey at planned destinations as well as during transits; "Always Exploring" is a guiding principle. This image shows the multibeam bathymetry data acquired during the ship's transit west from Oahu to the Johnston Atoll Unit. Image courtesy of NOAA OER.
<http://oceanexplorer.noaa.gov/oceanos/explorations/ex1706/dailyupdates/media/july11.html>

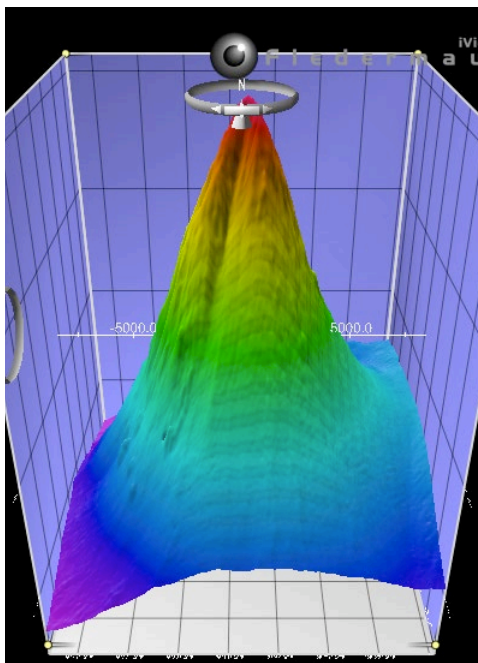

A multibeam sonar image of the Kawio Barat submarine volcano as viewed in iView4D software and using data collected during the NOAA OER INDEX-SATAL 2010 Expedition.



Mapping personnel on the Discovering the Deep: Exploring Remote Pacific MPAs expedition (L to R): Mapping Lead Derek Sowers, Watch Lead Jason Meyer, and Survey Technician Charles Wilkins. Image courtesy of NOAA OER, Discovering the Deep: Exploring Remote Pacific MPAs. <http://oceanexplorer.noaa.gov/oceanos/explorations/ex1703/logs/mar11/welcome.html>

Maximum Number of Students

30

Key Words and Concepts

Ocean Exploration
Okeanos Explorer
Bathymetric map
Multibeam sonar

Background Information

Multibeam sonar is one of the most powerful tools available for modern deep-sea exploration, and can create high-resolution maps, three dimensional models, or even “fly-through” videos that simulate a trip across the area being mapped. For more information about multibeam sonar, please see the *Introduction to Multibeam Sonar*.

An important technique for studying multibeam images uses a three-dimensional data visualization system called Fledermaus (which is the German word for “bat,” and is pronounced “FLEEDER-mouse”). This lesson introduces students to multibeam sonar technology and simple analysis of multibeam data using free viewing software for multibeam imagery in the Fledermaus file format. As the NOAA Ship *Okeanos Explorer* and other ships of exploration continue exploring/investigating Earth’s deep ocean, students will have additional opportunities to apply their analytic skills to investigate new multibeam images.

Learning Procedure

1. To prepare for this lesson:
 - a) Review *Ocean Mapping: An Essential Part of Ocean Exploration* by Derek Sowers, Jason Meyer, and Charles Wilkins <http://oceanexplorer.noaa.gov/oceanos/explorations/ex1703/logs/mar11/welcome.html>.
 - b) Review *Introduction to Ships of Exploration and Their Strategy for Ocean Exploration* <http://oceanexplorer.noaa.gov/oceanos/edu/collection/media/hdwe-StrategyBkgnd.pdf>, and *Introduction to Multibeam Sonar* <http://oceanexplorer.noaa.gov/oceanos/edu/collection/media/hdwe-MMBkgnd.pdf>.
 - c) If desired, download images to accompany discussions in Step 2. You may also want to download this “before and after” image to illustrate the capabilities of multibeam sonar: http://oceanexplorer.noaa.gov/oceanos/explorations/10index/background/hires/em302_before_after_hires.jpg, and <http://oceanexplorer.noaa.gov/oceanos/explorations/ex1703/logs/mar11/welcome.html>, as well as the following animation to accompany discussions in Step 3: http://oceanexplorer.noaa.gov/oceanos/media/movies/ex_podcast_video.html
 - d) Review background information on multibeam sonar technology and questions on the *Sonar Background Review*

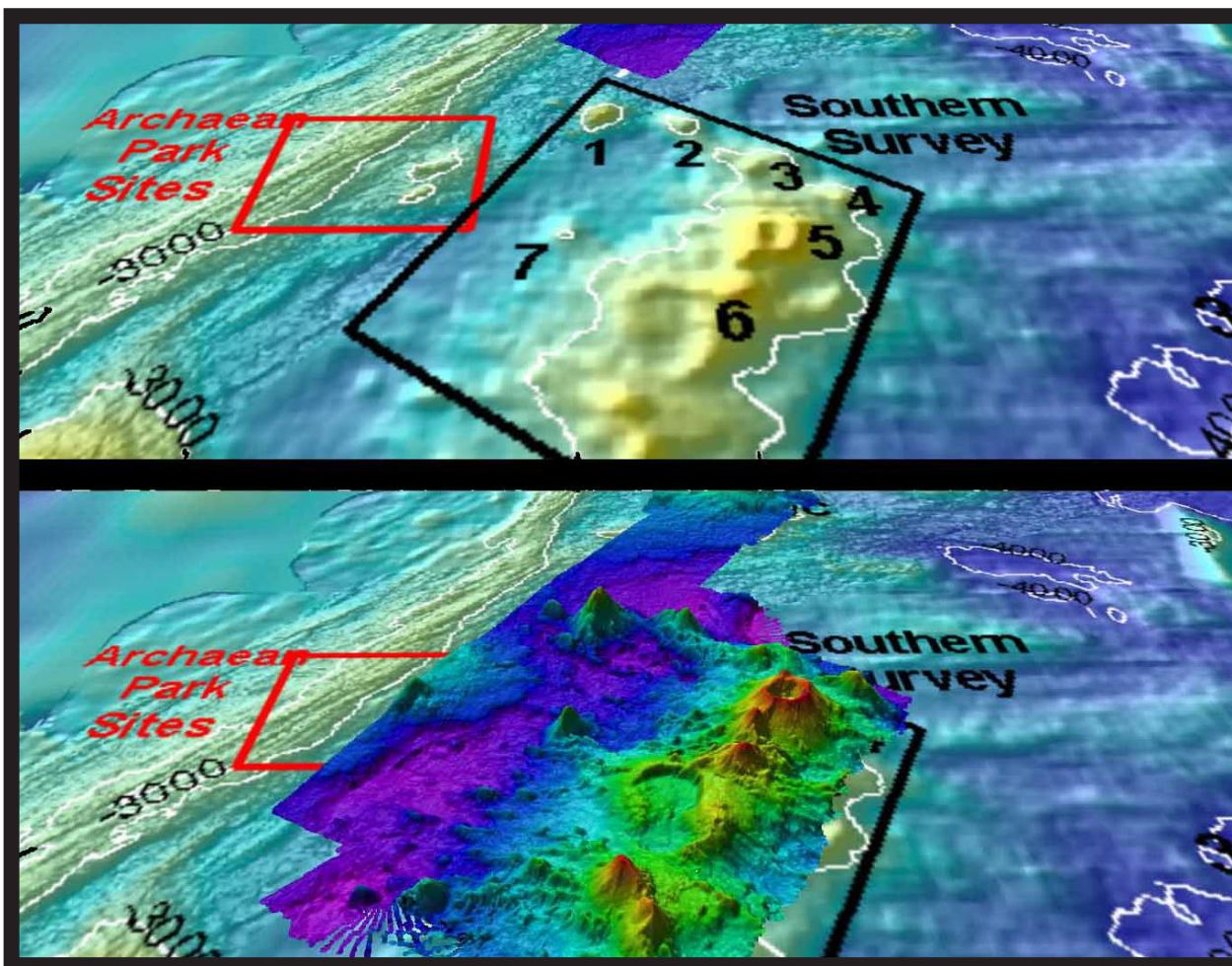

and *Introduction to Multibeam Imagery Worksheets* and make copies of *Sonar Background Review Worksheet* for each student, and copies of *Introduction to Multibeam Imagery Worksheet* for each student group.

- e) Download the iView4D software from <http://www.qps.nl/display/main/download>. You will need to fill in the contact form, then select the version appropriate to your operating system (Windows, Mac, and Linux versions are available; this download may take some time, so plan ahead!); download the data file **INDEX2010_mb_1.sd** from http://oceanexplorer.noaa.gov/oceanos/edu/resources/media/INDEX2010_mb_1.sd; and install these on computers that students will be using to complete the *Worksheet* activity. Alternatively, you may have students download these resources onto their own computers.

2. Provide each student with a copy of the *Sonar Background Review Worksheet* as homework in preparation for the remainder of this lesson.

This “before and after” image provides a glimpse of *Okeanos Explorer’s* EM302 mapping system capabilities in deep water. The top image shows what we previously knew about the seafloor terrain in the southern Mariana region from satellite altimetry data. The bottom image includes an overlay of the information provided by the ship’s EM302 multibeam system. Image courtesy of NOAA OER. http://oceanexplorer.noaa.gov/oceanos/explorations/10index/background/hires/em302_before_after_hires.jpg

Exploring the Deep Ocean with NOAA



One of the EM302 transducers installed on the hull of the NOAA Ship *Okeanos Explorer* in 2008. Image courtesy of NOAA OER.
<http://oceanexplorer.noaa.gov/okeanos/explorations/ex1503/logs/jun6/media/em302.html>

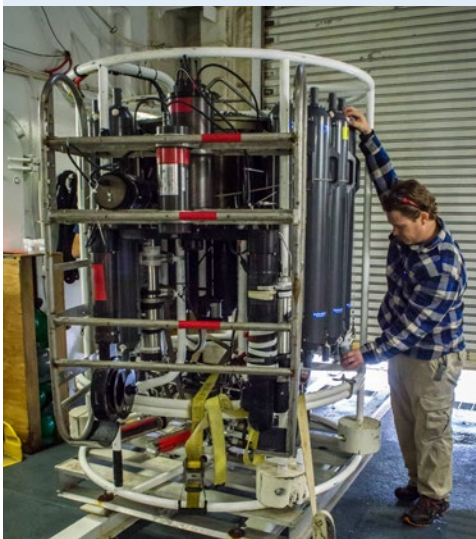

Water samples are collected from the Niskin bottles on the CTD. All 20 Niskin bottles take water samples from various depths, starting near the seafloor and ending close to the surface. Photo courtesy of Caitlin Bailey, GFOE, The Hidden Ocean 2016: Chukchi Borderlands.
<http://oceanexplorer.noaa.gov/explorations/16arctic/logs/july24/media/shipton.html>



Remotely operated vehicle *Deep Discoverer* being recovered. Image courtesy of NOAA OER, 2016 Deepwater Exploration of the Marianas.
<http://oceanexplorer.noaa.gov/okeanos/explorations/ex1605/logs/may1/media/1605rovrecovery.html>



The NOAA Ship *Okeanos Explorer*, America's ship for ocean exploration. Image courtesy NOAA.
<http://oceanexplorer.noaa.gov/okeanos/explorations/ex1702/logs/mar1/media/okeanos.html>

3. Briefly introduce the ships of exploration NOAA Ship *Okeanos Explorer*, E/V *Nautilus*, and R/V *Falkor*; the Introduction to Ships of Exploration and Their Strategy for Ocean Exploration <http://oceanexplorer.noaa.gov/okeanos/edu/collection/media/hdwe-StrategyBkgnd.pdf> and the 2017 Discovering the Deep: Exploring Remote Pacific MPAs Expedition <http://oceanexplorer.noaa.gov/okeanos/explorations/ex1703/background/plan/welcome.html>.

Briefly discuss why this kind of exploration is important (for background information, please see the lesson To Boldly Go... http://oceanexplorer.noaa.gov/okeanos/edu/collection/media/wdwe_toboldlygo.pdf. Highlight the overall exploration strategy used by ships of exploration, including the following points:

- The overall strategy is to develop baseline information about the biological, geological, and water chemistry features of unexplored areas to provide a foundation for future exploration and research.
- This information includes:
 - High resolution maps of the area being explored, as well as areas that the ship crosses while underway from one location to the next (underway reconnaissance);
 - Exploration of water column chemistry and other features; and
 - High definition close-up video of biological and geological features in the exploration area (site characterization).
- This strategy relies on four key technologies:
 - Multibeam sonar mapping system and other types of sonar that can detect specific features in the water column and on the seafloor;
 - Conductivity, Temperature, and Depth profilers (CTD) and other electronic sensors to measure chemical and physical seawater properties;
 - A Remotely Operated Vehicle (ROV) capable of obtaining

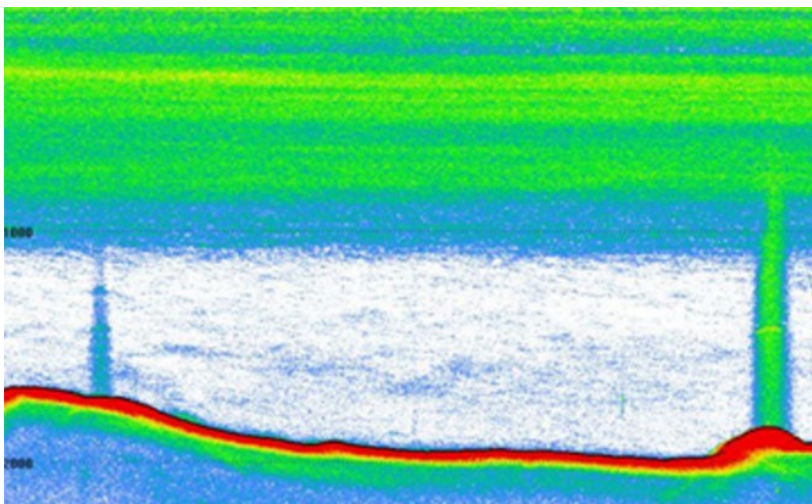

high-quality imagery and samples in depths as great as 6,000 meters; and

- Telepresence technologies that allow scientists with many different areas of expertise to observe and interact with exploration activities, though they may be thousands of miles from the ship.

You may want to show some or all of the images in the adjacent sidebar to accompany this review.

- Review students' answers to questions on the *Sonar Background Review Worksheet*. These may be compared with the answers provided.
- Ask students what they know about sonar, and provide additional information as necessary. Be sure students understand that sonar uses an acoustic signal or pulse of sound that is transmitted into the water by a sort of underwater speaker/microphone known as a transducer. If the seafloor or other object is in the path of the sound pulse, the sound bounces off the object and returns an "echo" to the sonar transducer. The time elapsed between the emission of the sound pulse and the reception of the echo is used to calculate the distance of the object. Since the time between transmission of a pulse and the return of its echo is the time

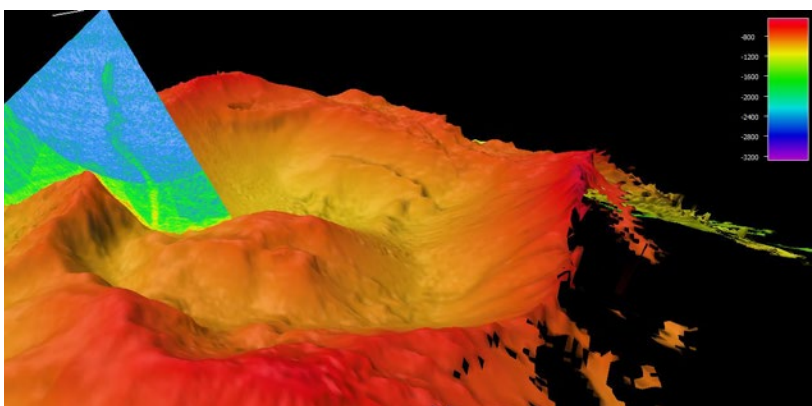

Example image of an echogram from EK60 fisheries sonar. The red feature is the seafloor. Green and blue areas in the water column are features with high backscatter, the lines near the surface show dense layers of biology (zooplankton, fish, gelatinous creatures, etc.), while the vertical lines are bubble plumes emanating from the seafloor. Image courtesy of NOAA OER, *Discovering the Deep: Exploring Remote Pacific MPAs*.

<http://oceanexplorer.noaa.gov/oceanos/explorations/ex1703/logs/mar11/media/echogram.html>



Picture of the EK60 split-beam transducer mounted on the hull of the *Okeanos Explorer*. Image courtesy of NOAA OER.

<http://oceanexplorer.noaa.gov/oceanos/explorations/ex1503/logs/jun6/media/ek60.html>



Global Foundation for Ocean Exploration Video Engineer Roland Brian adjusts the zoom, focus, and lighting on remotely operated vehicle *Deep Discoverer's* main HD camera to obtain the best shot of a tiny jellyfish. Image courtesy of NOAA OER, 2017 *Laulima O Ka Moana*.

<http://oceanexplorer.noaa.gov/oceanos/explorations/ex1706/dailyupdates/media/july27-2.html>

Multibeam sonar imagery shows a plume of bubbles rising from the seafloor at *Vailulu'u Seamount* near American Samoa. Image courtesy of NOAA OER, 2017 *American Samoa Expedition*.

<http://oceanexplorer.noaa.gov/oceanos/explorations/ex1702/logs/feb22/media/vailulu2.html>

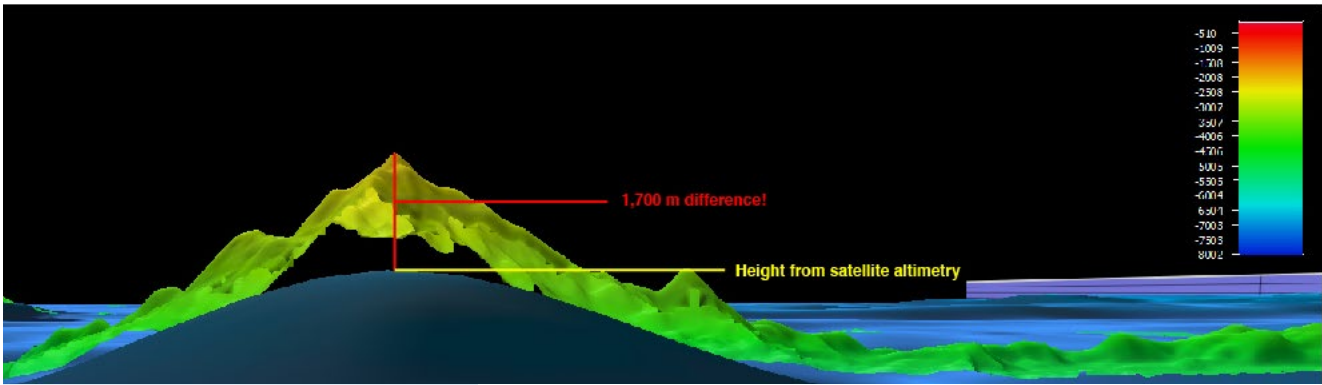

This image, from a multibeam sonar survey in the Pacific Remote Islands Marine National Monument, shows an approximately 1,700 meter seamount height difference when compared to previous satellite altimetry.
<http://oceanexplorer.noaa.gov/edu/images/WetMapsImageRev.jpg>

it takes the sound to travel to the bottom and back, if we know this time and the local speed of sound we can calculate the distance to the bottom (this distance is called range). The time measured between pulse transmission and echo return is the “round trip” time, so the pulse has travelled twice the range during this time. For this reason, the general formula for range is:

$$\text{range} = (1/2) (\text{local speed of sound}) (\text{echo time})$$

A multibeam sonar system uses multiple transducers pointing at different angles on either side of a ship to create a swath of signals. The time interval between signal transmission and return echo arrival is used to estimate depth over the area of the swath. In addition to high-resolution maps, multibeam data can be used to create three-dimensional models or even “fly-through” videos that simulate a trip across the area being mapped. You may want to show one or more of the images or video clips referenced in Step 1c.



Typical night time mapping watch in the control room. Image courtesy of NOAA OER.
http://oceanexplorer.noaa.gov/okeanos/explorations/10index/logs/aug05/media/night_watch.html

Describe the role of multibeam sonar in ocean exploration aboard *Okeanos Explorer*. The image above shows how much *Okeanos Explorer's* EM302 mapping system adds to what we know about seafloor terrain. <http://oceanexplorer.noaa.gov/edu/images/WetMapsImageRev.jpg>



Physical Scientist Meme Lobecker teaches Indonesian scientist Cecep Sujana how to conduct an XBT cast. The XBT measures temperature through the water column. The XBT software calculates sound velocity, which is applied to the multibeam data for accurate measure of bathymetry.
http://oceanexplorer.noaa.gov/okeanos/explorations/10index/logs/aug05/media/xbt_cast.html

Students should realize that multibeam and other sonar systems are the key technology for the “reconnaissance” component of the overall exploration strategy, and provides the “big picture” view as scientists explore the sea floor and the water column.

Show this image http://oceanexplorer.noaa.gov/okeanos/explorations/10index/logs/hires/xbt_cast_hires.jpg in which two scientists are conducting an XBT cast during the INDEX-SATAL 2010 Expedition. Be sure students understand that an XBT is an “expendable bathythermograph” which measures temperature through the water column. Ask students why this information is important to accurate multibeam operations. Students should realize that temperature affects the local speed of sound, which we have to know in order to calculate range as described above.

6. Provide each student group with a copy of the *Introduction to Multibeam Imagery Worksheet*, and ensure that students have access to the software and file referenced in Step 1e. Tell students that this activity is intended to familiarize them with multibeam imagery and how it can be manipulated to answer basic questions about features on the ocean floor. You may also want to mention that this skill will enable them to investigate additional images that will be available from future ocean exploration missions.

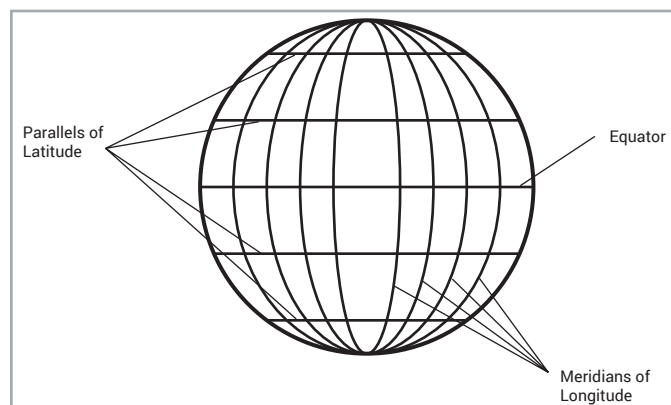

7. When students have answered the questions on the *Introduction to Multibeam Imagery Worksheet*, lead a discussion of their results. Students' answers may be compared with the answers provided.

The BRIDGE Connection

www.vims.edu/bridge/ – Scroll over “Ocean Science Topics” in the menu on the left side of the page, then “Human Activities,” then click on “Habitats” then select “Deep Ocean” for activities and links about deep ocean ecosystems.

The “Me” Connection

Have students write a brief essay describing a backpacking trip across a landscape having the topography shown in the multibeam image used for the activity in this lesson.

Connections to Other Subjects

English Language Arts, Mathematics, Social Studies

Assessment

Class discussions and students' work with the mapping simulation activity provide opportunities for assessment.

Multimedia Discovery Missions

<http://www.oceanexplorer.noaa.gov/edu/learning/welcome.html>

Click on the links to Lessons 1, 5 and 6 for interactive multimedia presentations and Learning Activities on Plate Tectonics, Chemosynthesis and Hydrothermal Vent Life, and Deep-Sea Benthos.

Other Relevant Lessons from NOAA OER

The Ridge Exploring Robot

<http://oceanexplorer.noaa.gov/explorations/10chile/background/edu/media/robot.pdf>

Focus: Autonomous Underwater Vehicles/Marine Navigation (Grades 9-12; Earth Science/Mathematics)

Latitude and Longitude

If students are not familiar with the concepts of latitude and longitude, see *The Robot Archaeologist* (<http://oceanexplorer.noaa.gov/explorations/09newworld/background/edu/media/robot.pdf>), page 11.

Degrees, Minutes, Seconds or Decimal Degrees?

The iView4D software provides longitude and latitude (x and y “Geo Coords” on the bottom left of the viewer window) in degrees, minutes, and seconds; but the Digital Atlas uses the decimal degree format.

To convert degrees/minutes/seconds to decimal degrees:

1. Convert seconds to minutes, and add to minutes.
2. Convert minutes to degrees, and add to degrees.

For example, to convert 4° 44' 49" to decimal degrees:

1. Divide 49" by 60 seconds/minute = 0.81667; add to 44' = 44.81667'
2. Divide 44.81667' by 60 minutes/degree = 0.74694°; add to 4° = 4.74694°

To convert decimal degrees to degrees/minutes/seconds:

1. Multiply the decimal portion of the number by 60. The whole number portion of the result is minutes.
2. Multiply the decimal portion of the result by 60 to find the number of seconds.

For example, to convert 4.74694° to degrees/minutes/seconds:

1. Multiply 0.74694 by 60 = 44.8164. The number of minutes is 44.
2. Multiply 0.8164 by 60 = 48.984. The number of seconds is 49.

So, 4.74694° = 4° 44' 49"



The Next Generation Science Standards
The Next Generation Science Standards integrate three dimensions within each standard: Science and Engineering Practices, Disciplinary Core Ideas, and Crosscutting Concepts. The standards are written as student performance expectations. While specific performance expectations may emphasize only a few of the practice categories, teachers are encouraged to utilize several practices in any instruction. Similarly, only a few crosscutting concepts may be emphasized, but this is not intended to limit instruction.

Students explain a three-phase strategy that uses an Autonomous Underwater Vehicle (AUV) to locate, map, and photograph previously undiscovered hydrothermal vents; design a survey program to provide a photomosaic of a hypothetical hydrothermal vent field; and calculate the expected position of the AUV based on speed and direction of travel.

Sound Pictures

<http://oceanexplorer.noaa.gov/explorations/10sanandreas/background/edu/media/soundpics912.pdf>

Focus: Sonar (Grades 9-12; Physical Science)

Students explain the concept of sonar, describe the major components of a sonar system; explain how multibeam and side-scan sonar systems are useful to ocean explorers; and simulate sonar operation using a motion detector and a graphing calculator.

Next Generation Science Standards and Ocean Literacy Essential Principles and Fundamental Concepts

This lesson supports the Ocean Literacy Essential Principles and Fundamental Concepts as indicated here <http://oceanexplorer.noaa.gov/oceanos/edu/collection/media/hdwe-Standards.pdf>. Additionally, while it is not intended to target specific Next Generation Science Standards, activities in this lesson may be used to address specific elements of the NGSS as described below.

Specific NGSS Performance Expectation relevant to this lesson is:

MS-ESS2-3. Analyze and interpret data on the distribution of fossils and rocks, continental shapes, and seafloor structures to provide evidence of the past plate motions. [Clarification Statement: Examples of data include similarities of rock and fossil types on different continents, the shapes of the continents (including continental shelves), and the locations of ocean structures (such as ridges, fracture zones, and trenches).] [Assessment Boundary: Paleomagnetic anomalies in oceanic and continental crust are not assessed.]

Discussion about multibeam sonar may be linked to the geographic distribution of underwater volcanoes and how this distribution provides evidence of plate motions.

For Information and Feedback

We value your feedback on this lesson, including how you use it in your formal/informal education settings. Please send your comments to: oceaneducation@noaa.gov

Acknowledgments

Produced by Mel Goodwin, PhD, Marine Biologist and Science Writer, Charleston, SC. Design/layout: Coastal Images Graphic Design, Charleston, SC. If reproducing this lesson, please cite NOAA as the source, and provide the following URL: <http://oceanexplorer.noaa.gov>

Sonar Background Review Worksheet

1. How are sound waves in water different from electromagnetic waves such as light or radio waves?
2. What are some conditions that affect the speed of sound waves travelling in water?
3. Sound waves may be thought of as a sequence of moving pressure fronts. What is the term for the physical distance between two consecutive pressure fronts?
4. What is the term for the number of pressure fronts that pass a stationary point in a certain amount of time?
5. What is the mathematical relationship between the properties described in Questions 3 and 4?
6. When a sound wave moving through water encounters a change in temperature, what happens to the properties described in Questions 3 and 4?
7. When a sound wave moves through the water, what is it that is actually moving?
8. Instruments called hydrophones measure the changes in pressure caused by the pressure fronts of a sound wave. If one sound wave is found to cause greater pressure changes than another sound wave, what does this indicate about the two waves?
9. The pressure caused by a sound wave is directly related to a third property of waves. What is this property?
10. What happens to the property identified in Question 9 as a sound wave moves through water?
11. How is the effect identified in Question 10 related to the property identified in Question 4?
12. When a sound wave moving through water encounters another medium, such as rock or sand, what are three things that happen to the quantity identified in Question 7?

Section of map showing planned mapping survey lines in yellow. Publicly available bathymetry in the background downloaded from NOAA's National Centers for Environmental Information archives and collected on various survey platforms. Image courtesy of NOAA OER. <http://oceanexplorer.noaa.gov/oceanos/explorations/ex1707/media/ex1707-fz.html>

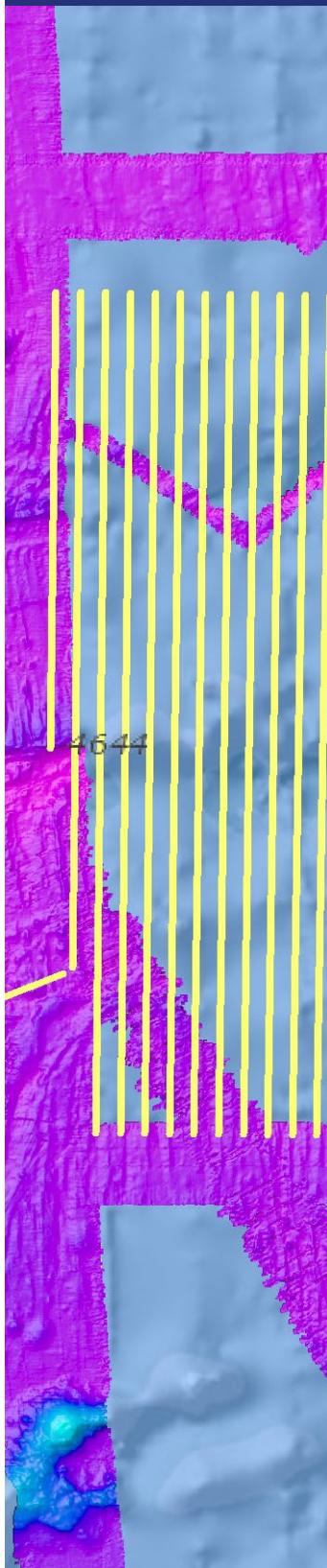

Sonar Background Review Worksheet Answers

1. Sound waves in water move as compression waves, while electromagnetic waves are transverse waves.
2. The speed of sound waves travelling in water is affected by conditions of the water such as salinity, pressure, and temperature; the speed of sound waves under a particular set of these conditions is called the local speed of sound. In the ocean, the speed of sound is about 1,500 meters per second.
3. The physical distance between two consecutive pressure fronts in a sound wave is wavelength.
4. The number of pressure fronts that pass a stationary point in a certain amount of time is the frequency of the wave.
5. The mathematical relationship between wavelength and frequency is:
$$\text{speed of sound} = \text{frequency} \times \text{wavelength}$$
Typically, wavelength is measured in meters (m), and frequency is measured in cycles per second (Hz), so units for the speed of sound are meters per second.
6. When a sound wave moving through water encounters a change in temperature, the local speed of sound and wavelength change, but frequency remains constant.
7. When a sound wave moves through the water, energy is the thing that actually moves.
8. If one sound wave induces a greater pressure change than another sound wave, the first sound wave contains more energy.
9. The pressure caused by a sound wave is directly related to the amplitude of the wave, which is related to the acoustic energy of the wave; higher amplitude waves contain more energy.
10. When a sound wave moves through water, it gradually loses some of its energy, so its amplitude is reduced.
11. Sound waves with higher frequencies lose energy more rapidly than those with lower frequencies.
12. When a sound wave moving through water encounters another medium, some of its energy is transferred into the new medium, some of it is reflected off the surface of the medium, and the rest is scattered in all directions. How much energy is reflected and how much is scattered depends on the characteristics of the medium and the angle at which the wave strikes the medium (angle of incidence). The energy that is reflected maintains the frequency characteristics of the original sound wave.

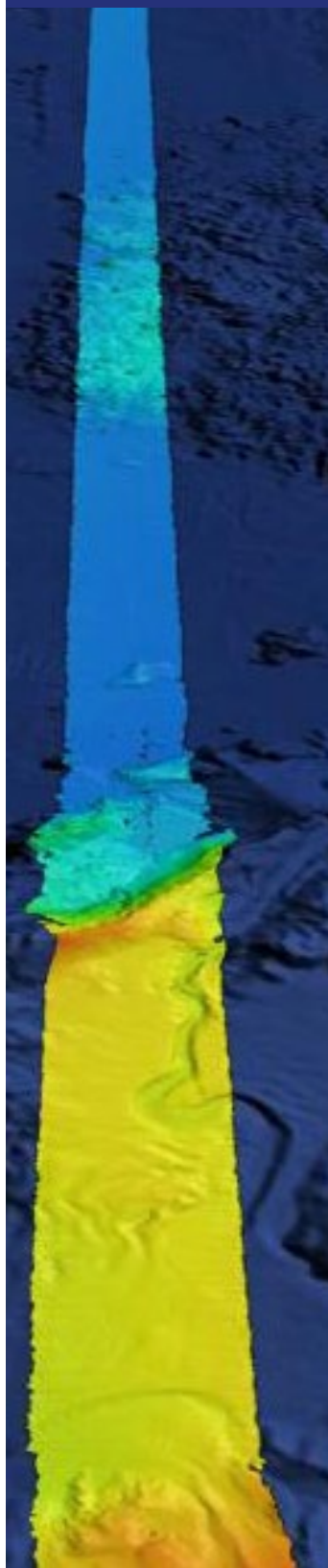

Introduction to Multibeam Imagery Worksheet

1. Launch the iView4D software. Your screen should resemble Figure 1. Note the Rotation Control Rings near the top center and mid-left side of the screen. If your screen doesn't look like Figure 1, be sure "Bounds" is checked under the "View" drop-down menu.

Figure 1.

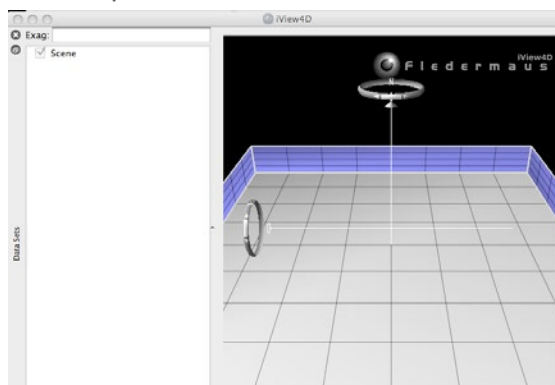

2. Open the file, **INDEX2010_mb_1.sd**. Now your screen should resemble Figure 2.

This is a multibeam sonar image of the Kawio Barat submarine volcano which was identified as a priority for exploration during the INDEX-SATAL 2010 Expedition.

Figure 2.

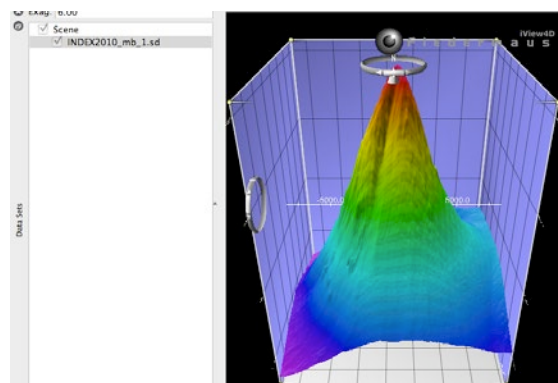

The ocean floor is shown as a three-dimensional image. The x-axis represents longitude, the y-axis represents latitude, and the z-axis represents depth. When you move the cursor over the image, the window

The NOAA Office of Ocean Exploration and Research pursues every opportunity to map, sample, explore, and survey at planned destinations as well as during transits; "Always Exploring" is a guiding principle. Mapping data is collected at all times when the ship is transiting and underway. This image shows the multibeam bathymetry data acquired during the ship's transit west from Oahu to the Johnston Atoll Unit. Image courtesy of NOAA OER. <http://oceanexplorer.noaa.gov/oceanos/explorations/ex1706/dailyupdates/media/july11.html>

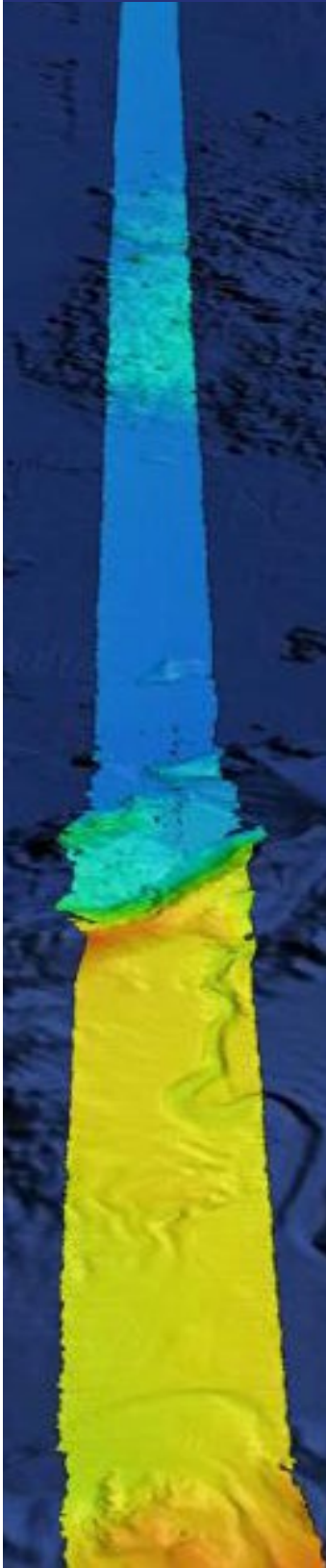

near the bottom of the screen shows the geo coordinates (x, y, and z) for the location beneath the cursor.

The Rotation Control Ring near the top allows you to rotate the image around the vertical axis, and the Rotation Control Ring on the left allows you to rotate the image around the horizontal axis. Alternatively, you can left-click (simple click on a Macintosh platform) and drag up or down to rotate the image around the horizontal axis, or left-click and drag left or right to rotate the image around the vertical axis.

You can zoom the image by right-clicking (or control-clicking on a Macintosh platform) in the middle of the image, then dragging to zoom in or out.

Some images use “vertical exaggeration” to show features more clearly. This means that the vertical scale is larger than the horizontal scale so vertical features are magnified. You can control the amount of vertical exaggeration by clicking and dragging the cone-shaped object on the vertical scale line near the middle of the image. Numbers on the scale lines show the relative horizontal and vertical scales.

Experiment with these controls to find out how they allow you to manipulate the image.

3. Answer the following questions:

- a. What are the northern and southern latitude boundaries for this image? (Hint: The Rotation Control Ring on the left allows you to rotate the image so that you are looking straight down.)
- b. What are the eastern and western longitude boundaries for this image?
- c. The deepest parts of the image are approximately how deep?
- d. How deep is the shallowest part of this volcano? (Hint: Increasing the vertical exaggeration will make it easier to spot the shallowest portion.)
- e. What is the approximate diameter of the volcano at its base? (Hint: One minute of latitude is equal to one nautical mile, which is equal to 1.852 km; but note that the squares on the Fledermaus image are not necessarily equal to one minute.)
- f. What is the approximate slope of the volcano? (Hint: Think of the volcano as a right triangle whose base is one-half the volcano’s diameter.)
- g. Often, areas where local topography is steep or very changeable will also be areas that have a variety of biological organisms. What is the approximate location of an area on the volcano that seems to have this kind of topography? (Hint: This is easier to see without vertical exaggeration.)

Answers for Multibeam Imagery Worksheet

- a. The northern and southern latitude boundaries for the image are about $4^{\circ} 44' 49''$ (4.7469°) N latitude and about $4^{\circ} 36' 10''$ (4.6028°) N latitude respectively. Reading the numbers on the latitude and longitude scales can be difficult; an easier way to find this information is to rotate the image so that we are directly overhead, then place the cursor near the edges of the image and read the latitude and longitude coordinates from the window on the lower left.
- b. The eastern and western longitude boundaries for this image are about $125^{\circ} 9' 39''$ (125.1608°) E longitude and about $125^{\circ} 01' 02''$ (125.0172°) E longitude, respectively.
- c. The deepest parts of the image are approximately 5,400 meters deep (near the northwestern edge of the image).
- d. The shallowest part of this volcano is about 1,870 meters deep.
- e. We can estimate the diameter of the volcano by finding the north and south latitude boundaries of the base. If we use the edge of the light blue shading as the base (the actual base is deeper than this, but is not completely shown in the image; students may select a different outer boundary, in which case the following calculations will need to be adjusted, but the calculation technique is the same), the northern latitude boundary is about $4^{\circ} 44' 21''$ (4.73917°) N, and the southern latitude boundary is about $4^{\circ} 36' 16''$ (4.60444°) N. The difference between these numbers is $8' 5''$. Since one minute of arc is equal to 60 seconds of arc, 5 seconds is equal to

$$5 \div 60 = 0.083 \text{ minute}$$

So the diameter is approximately 8.083 minutes, which is equal to 8.083 nautical miles, which is equivalent to

$$8.083 \text{ nm} \cdot 1.852 \text{ km} = 14.97 \text{ km}$$

- f. To calculate the approximate slope of the volcano using the triangle hint, we need to know the diameter and height of the volcano. If we continue to use the edge of the light blue shading as the base, the depth at this point is about 4,539 m. Since the shallowest part of the volcano is about 1,870 m, its height is approximately 2,669 m. If the base of the triangle is one-half the volcano's diameter, this is equal to

$$0.5 \cdot 14.97 \text{ km} = 7.485 \text{ km} = 7,485 \text{ m}$$

The slope of the volcano is the angle between the side of the triangle and its base. The tangent of this angle is equal to the height divided by the base:

$$\tan \text{ slope} = 2,669 \text{ m} \div 7,485 \text{ m} = 0.357$$

The arctangent of 0.357 is the angle of the slope, which is equal to 19.6 degrees. If we set the vertical exaggeration in the upper left window to 1.0 (no exaggeration), this estimation looks reasonable.

- g. The deep valley on the southwestern side of the volcano, running roughly between $4^{\circ} 40' 24''$ (4.6733°) N, $125^{\circ} 5' 11''$ (125.0864°) E and $4^{\circ} 39' 38''$ (4.6606°) N, $125^{\circ} 4' 44''$ (125.0789°) E appears to have relatively steep topography and would be an interesting place to look for biological organisms.

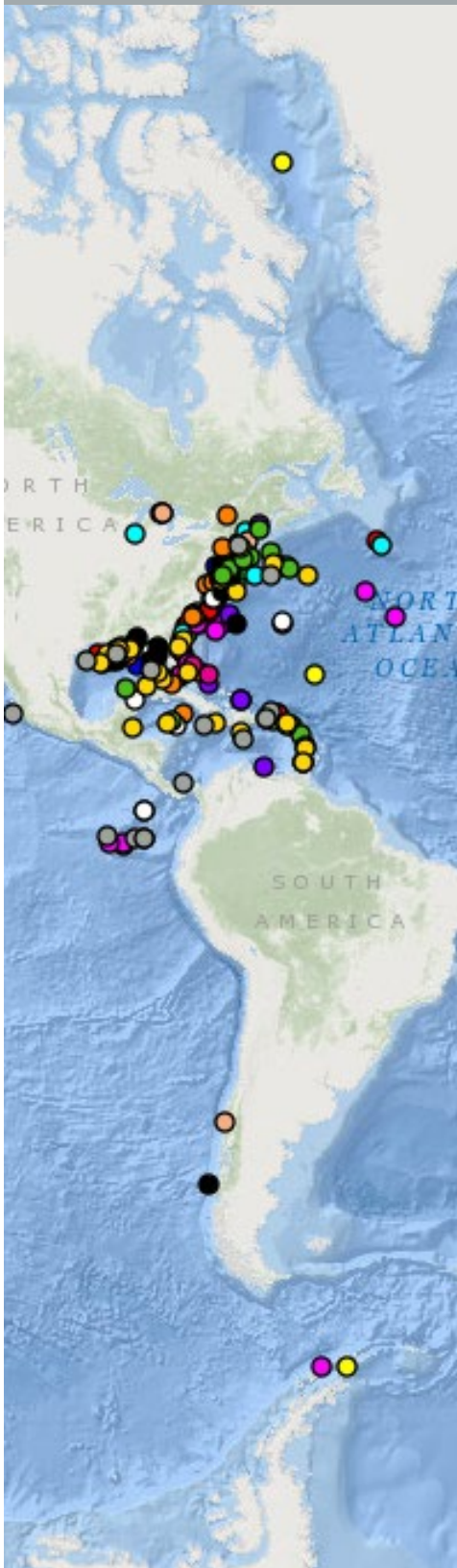

How to Use the Ocean Explorer Digital Atlas

NOAA Ocean Explorer missions are always full of surprises, because they often occur in places where literally no one has gone before. To help share the excitement of ocean exploration, NOAA's National Coastal Data Development Center (NCDDC) provides a map-based atlas that links to information about past expeditions of NOAA's Ocean Explorer program that began in 2001 (see the Ocean Exploration Digital Atlas at http://www.ncddc.noaa.gov/website/google_maps/OE/mapsOE.htm). This atlas is an excellent teaching tool to orient students to expedition locations and provide experiences exploring data and associated discoveries from specific expeditions.

This Supplement describes how geographical and mapping data marry with expedition website data and selected interactive scene files from key discoveries. The Digital Atlas can be used to obtain information about past NOAA Ocean Explorer expeditions, education resources associated with the expeditions, ship tracks, bathymetric maps, dive tracks, and more.

The following example shows how the Digital Atlas can be used to find out exactly where specific expeditions were taking place and information about discoveries, and shares methods for exploring scientific data collected by the ship. Begin here and then, to explore additional explorations using the digital atlas and seafloor structures using the Fledermaus software, try the additional activities focused on other seafloor features linked at the end of this supplement.

In preparation for using Fledermaus in the supplements, you will need to download the free iView4D software from <http://www.qps.nl/display/main/download>. You will need to fill in the contact form, then select the version appropriate to your operating system (Windows, Mac, and Linux versions are available; this download may take some time, so plan ahead!).

A screen grab from the map on the Digital Atlas web site. The database can be searched by Expedition, Year, Theme, Text or Custom Search.
https://www.ncddc.noaa.gov/website/google_maps/OE/mapsOE.htm

INDEX-SATAL Expedition 2010 Kawio Barat Volcano

This *Digital Atlas* exploration is a supplement to the *Watching in 3D* lesson.

1. Open the Ocean Explorer Digital Atlas at http://www.ncddc.noaa.gov/website/google_maps/OE/mapsOE.htm
2. In the left column click on the **Search by Text** tab at the bottom. In the text box type **Indonesia**. The dots that will appear on the map are the *Okeanos Explorer* expeditions in the Pacific region in 2010.

The screenshot shows the NOAA Ocean Explorer Digital Atlas interface. The browser address bar displays 'www.ncddc.noaa.gov'. The page title is 'Ocean Exploration and Research' and 'Digital Atlas'. The main content area features a world map with several orange dots indicating expedition locations in the Pacific region. On the left, there is a search panel with 'Search by Text' selected and 'Indonesia' entered in the search box. On the right, a list of expeditions is displayed, with the fifth entry highlighted: '2010 - Okeanos Explorer EX100402; Transit from Guam to Hawaii'. Below the map, there is a scale bar and coordinates: 'Longitude: 151.02 Latitude: 49.59'. At the bottom, there are links for 'U.S. Department of Commerce | NOAA | NESDIS | NCEI | Information Quality | Freedom of Information Act (FOIA) | Disclaimer | Privacy Policy | Copyright Notice | USA.gov'.

3. In the column on the right, find the 2010 *Okeanos Explorer* INDEX-Indonesia-USA Deep-Sea Exploration of the Sangihe Talaud Region (EX100402). This is #5 in the list. Tell students that cruises are named with an abbreviation of the ship name ("EX" is used as an abbreviation for *Okeanos Explorer*), the last two digits of the year in which the cruise took place ("10"), the number of the cruise (this was the fourth cruise for 2010), and the segment or leg (this was the second leg of cruise 04). Click on this cruise and you will see a pop up box as illustrated in the figure on the next page.

Notice the tabs provided at the top of the pop up window. For educator information related to this cruise click on the **Education** tab. This will take you to several educational resources available on the Ocean Explorer website related to this

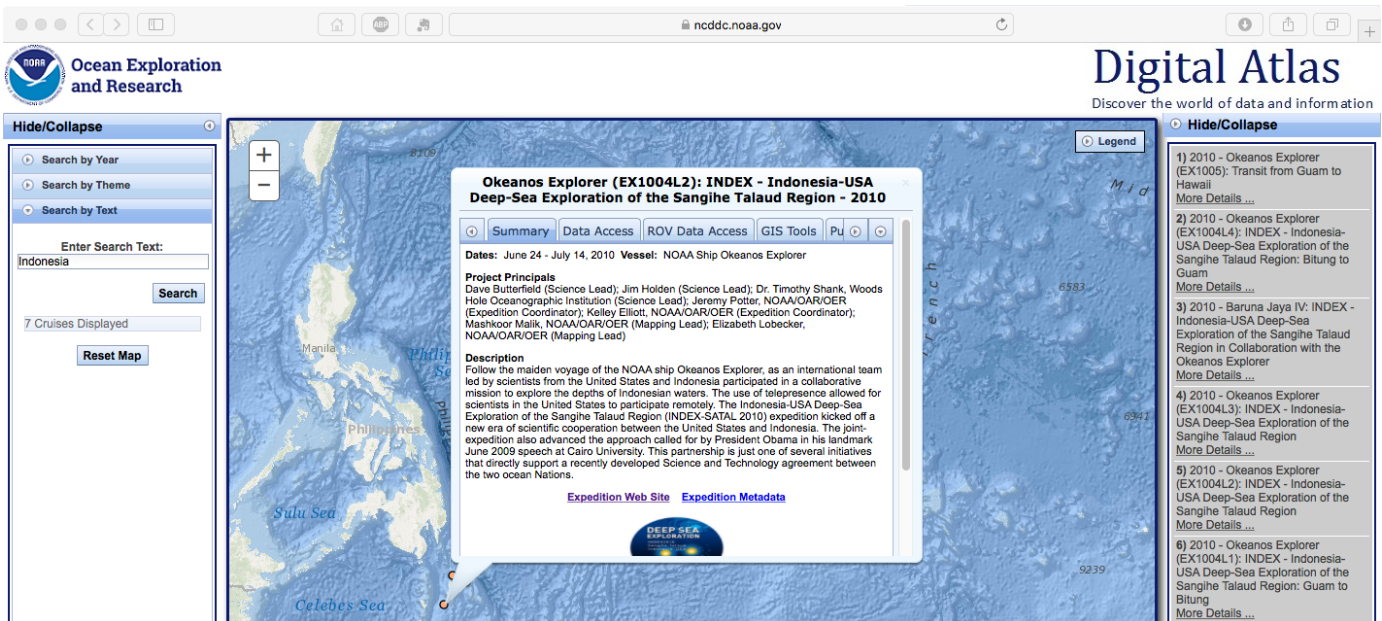

expedition including an Expedition Education Module, which provides background information, lessons, and more resources associated with the expedition.

- Now click on the **GIS Tools** tab in the pop up window, select the first four boxes (see screen shot at right), and click **Plot on Map**. Give the map a moment to load and what appears should look like the figure below. This shows the ship's entire cruise track and the bathymetric mapping work done throughout the expedition. Point out the light pink lines, which show the ship's track, and ask students why the ship seems to be tracking back and forth. Explain to students that the first step in the ship's exploration strategy is mapping and that the ship is obtaining high-resolution multibeam maps of the area being explored (this is called "mowing the lawn," for obvious reasons). The stars are locations where the Remotely Operated Vehicle (ROV) dove during this expedition.

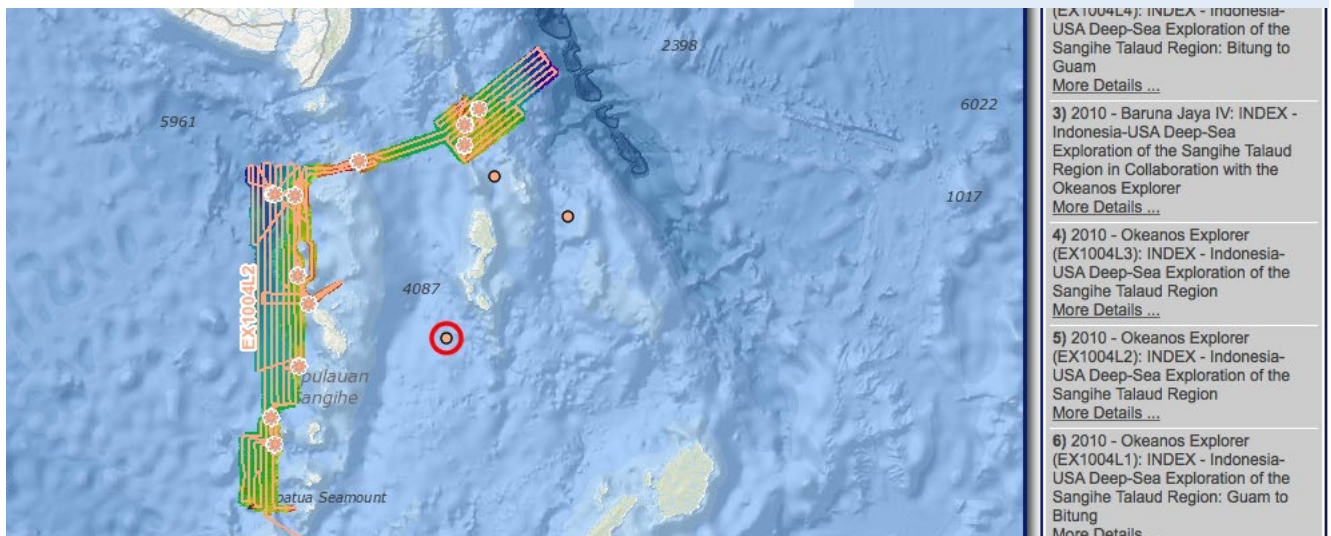
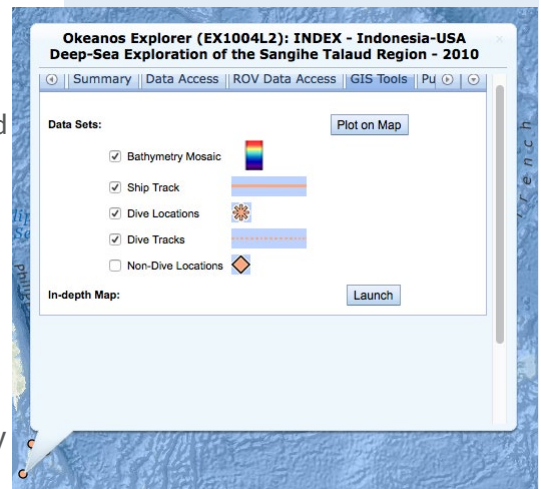

5. Using the center mouse button, zoom in until you see the names of the dives appear. Look for EX1004L2 Dives 1 and 2. (Latitude 4.69, Longitude 125.08) Hint: Hold the left mouse button down to move the map around.

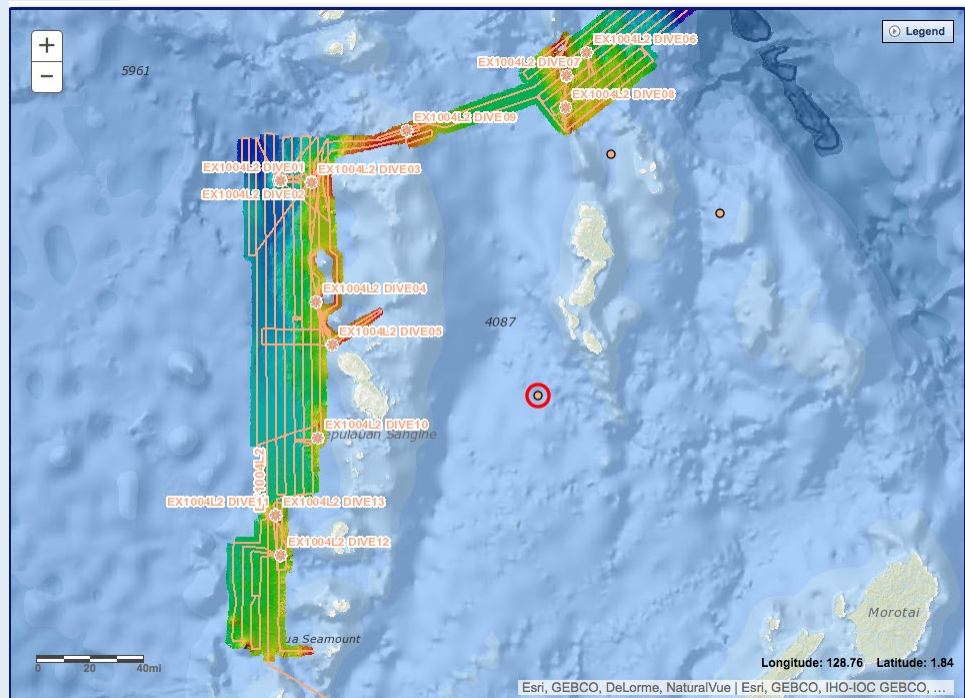

6. Zoom in closer until you see the formation of a seamount at these two dive sites. Your screen should look something like the image below.

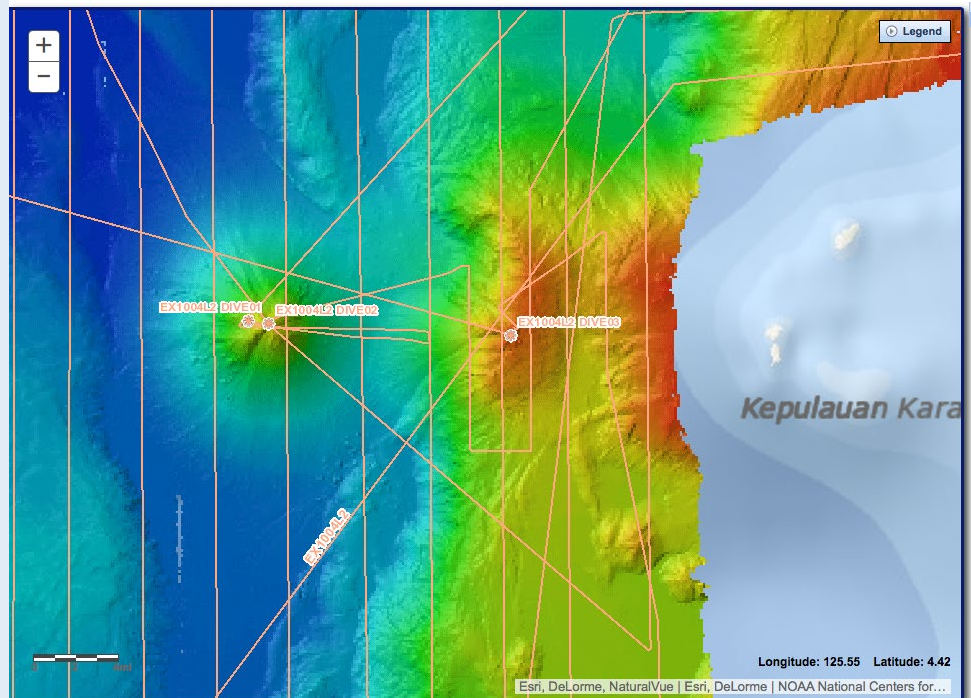

7. *Optional:* This is an ideal point to do the Introduction to Multibeam Imagery Worksheet in the *Watching in 3D* lesson.

8. After students complete the Multibeam Imagery Worksheet from *Watching in 3D*, go back to the Digital Atlas and click on the EX100402 expedition box on the right, #5, again. In the pop up window **Summary** tab will be a link to the expedition on the Ocean Explorer website. Click on **Expedition Website**. This is the main INDEX-SATAL 2010 Expedition webpage. Notice the **Daily Logs** on the right side of the page. Click on June 26. This log corresponds to the Dives 1 and 2 found within the Digital Atlas.

Have students:

- Read the log.
- Click on the fly through animation of the multibeam sonar data (in this animation you will see one dive track of the ROV on this volcano.)
- After reading the log and watching the video, ask students:
 - What types of ocean scientists were participating in this exploration? Why are a variety of scientists necessary to fully explore an area?
 - If you could go back now, what would you want to explore further? Why?

Extensions

1. Have students read the Daily Log from June 27, 2010, the day after the ROV explored the Kawio Barat volcano. What else were they looking for? (new hydrothermal vents)
2. Try the lesson *The Oceanographic Yo-yo* <http://oceanexplorer.noaa.gov/oceanos/edu/collection/media/hdwe-WCYoYo78.pdf> to see what they found! (evidence of a hydrothermal vent and vent community)

Additional Resources

[Ocean Explorer Seamounts Theme page](http://oceanexplorer.noaa.gov/themes/seamounts/welcome.html)

<http://oceanexplorer.noaa.gov/themes/seamounts/welcome.html>

This page compiles some of the best ocean explorer education resources on seamounts including essays, lessons, multimedia activities and links to past expeditions.

[Seamounts, Les Watling Ph.D., University of Hawai'i at Manoa](https://vimeo.com/88841596)

<https://vimeo.com/88841596>

In this 45 minute video, Dr. Les Watling, marine scientist at the University of Hawai'i at Manoa, provides an excellent description of the formation of seamounts, their geology and their associated ecological and biological diversity.

To use the Digital Atlas and learn how to use the Fledermaus software, try the following activities:

Northeast US Canyons Expedition 2013: Mytilus Seamount

<http://oceanexplorer.noaa.gov/oceanos/edu/collection/media/mytilus.pdf>

Northeast US Canyons Expedition 2013: Cold Seeps

http://oceanexplorer.noaa.gov/oceanos/edu/collection/media/cold_seeps.pdf

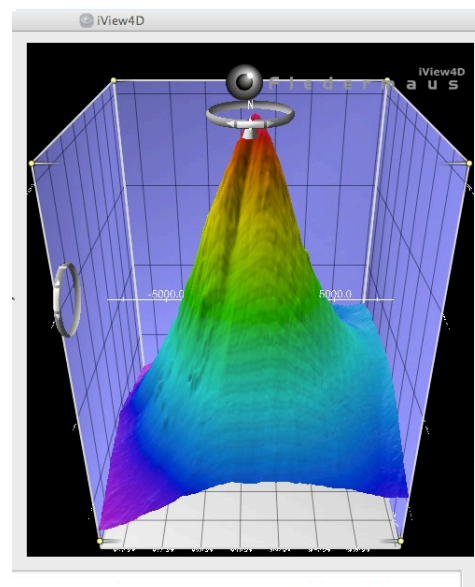

A multibeam sonar image of the Kawio Barat submarine volcano as viewed in iView4D software and using data collected during the NOAA OER INDEX-SATAL 2010 Expedition.

Send Us Your Feedback

We value your feedback on this lesson, including how you use it in your formal/informal education settings.

Please send your comments to: oceaneducation@noaa.gov

Acknowledgments

Design/layout: Coastal Images Graphic Design, Charleston, SC. If reproducing this lesson, please cite NOAA as the source, and provide the following URL: <http://oceanexplorer.noaa.gov>

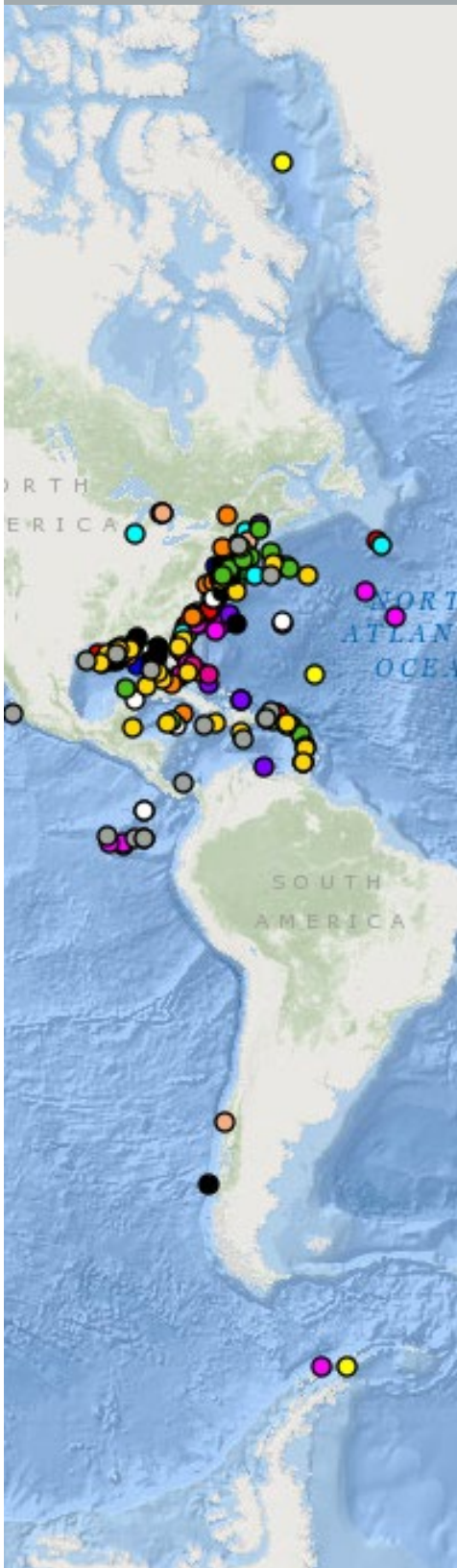

Northeast U.S. Canyons Expedition 2013: Mytilus Seamount

This activity illustrates how to use the Digital Atlas and how to use the Fledermaus software, and extends the Ocean Explorer Digital Atlas Supplement to explore a different location.

1. Open the Ocean Explorer Digital Atlas at http://www.ncddc.noaa.gov/website/google_maps/OE/mapsOE.htm.
2. In the left column click on the **Search by Text** tab at the bottom. In the text box type *Okeanos Explorer*. The dots that will appear on the map are all of the *Okeanos Explorer* expeditions color-coded by year.

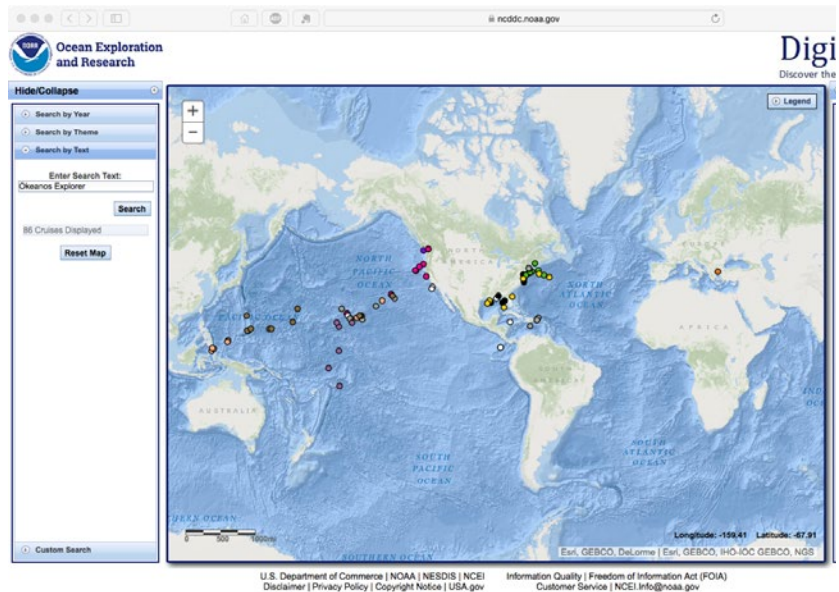

3. In the column on the right, scroll to find the 2013 *Okeanos Explorer* Northeast U.S. Canyons Expedition (EX1304L2). Tell students that cruises are named with an abbreviation of the ship name ("EX" is used as an abbreviation for *Okeanos*

A screen grab from the map on the Digital Atlas web site showing sites of Ocean Explorer cruises. The database can be searched by Expedition, Year, Theme, Text or Custom Search. https://www.ncddc.noaa.gov/website/google_maps/OE/mapsOE.htm

Explorer), the last two digits of the year in which the cruise took place ("13"), the number of the cruise (this was the fourth cruise for 2013), and the segment or leg (this was the second leg of cruise 04). Click on this cruise and you will see a pop up box as illustrated in the figure below.



Notice the tabs provided at the top of the pop up window. For educator information related to this cruise, click on the **Education** tab. This will take you to several educational resources available on the Ocean Explorer website related to this expedition including an Expedition Education Module which provides background information, an introductory video, lessons and more resources associated with the expedition.

The Northeast U.S. Canyons Expedition <http://oceanexplorer.noaa.gov/okeanos/explorations/ex1304/welcome.html> took place during the summer of 2013. During this expedition, a team of scientists and technicians both at-sea and on shore conducted exploratory investigations on the diversity and distribution of deep-sea habitats and marine life along the Northeast U.S. Canyons and at Mytilus Seamount, located within the U.S. Exclusive Economic Zone. The 36-day expedition complemented work done through the 2012 Atlantic Canyons Undersea Mapping Expeditions (ACUMEN <http://oceanexplorer.noaa.gov/okeanos/explorations/acumen12/welcome.html>).

The expedition also marked the first time NOAA's new 6,000 meter remotely operated vehicle (ROV), *Deep Discoverer* <http://oceanexplorer.noaa.gov/technology/subs/deep-discoverer/deep-discoverer.html> and the *Seirios* <http://oceanexplorer.noaa.gov/okeanos/explorations/ex1708/logs/sept26/welcome.html> camera sled and lighting platform were used in a full telepresence-enabled ocean exploration with NOAA Ship *Okeanos Explorer*. When these systems were deployed from the ship, the expedition team was able to provide scientists and audiences onshore with real-time video footage from deepwater areas in important, largely unknown, U.S. waters.

4. Click on the **GIS Tools** tab in the pop up window, select the first four boxes, and click **Plot on Map**.

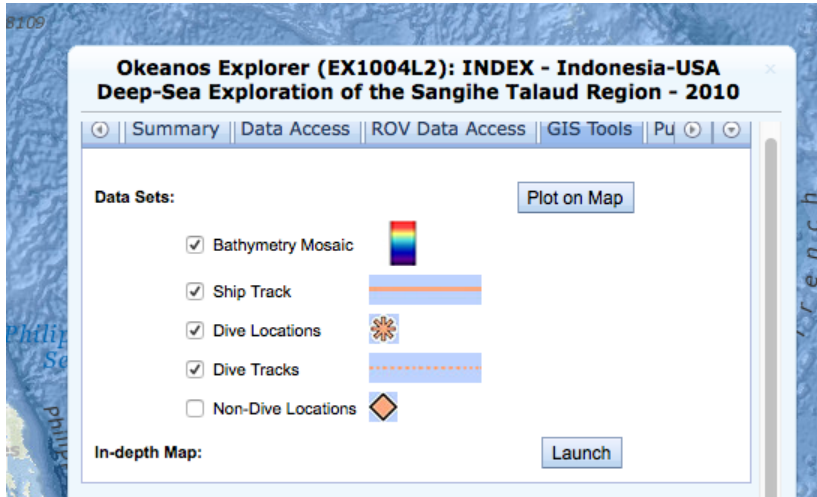

Give the map a moment to load and what appears should look like the figure below.

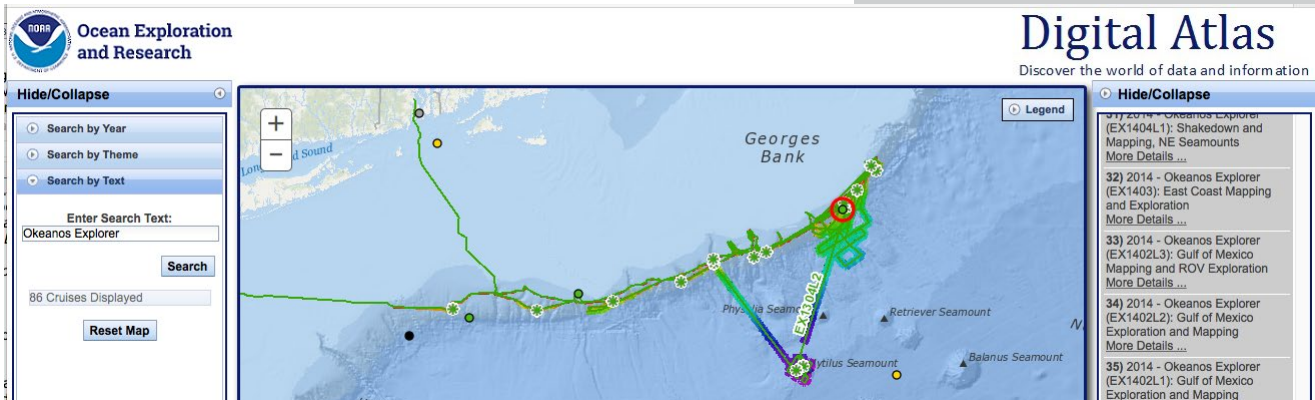

This shows the ship's entire cruise track and the bathymetric mapping work done throughout the expedition.

- Click on the map and holding the left cursor down, move the view slightly to the right. A number of named seamounts should come in to view. Notice that Mytilus Seamount was mapped during this mission.

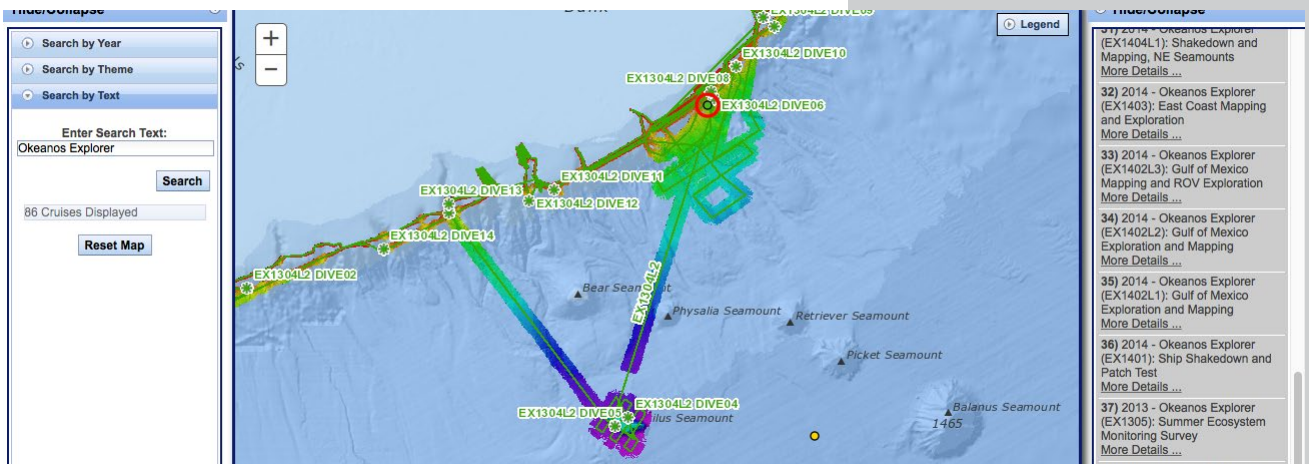

Hide/Collapse

▶ Search by Year

▼ Search by Theme

- Biodiversity
- Bioluminescence
- Biotechnology
- Canyons
- Caves
- Chemosynthetic Communities
- Deep-Sea Corals
- Faults
- Habitat Characterizations
- Marine Archaeology
- Microbiology
- Sampling Operations
- SCUBA and Technical Diving
- Seafloor Mapping
- Seamounts
- Seeps and Vents
- Sound and Light
- Submersibles
- Telepresence
- Testing New Technologies
- Trenches
- Volcanoes

No Themes All Themes

312 Cruises Displayed

Reset Map

Themes that can be searched in the OER Digital Atlas.

6. Using the center mouse button, zoom in on Mytilus Seamount as illustrated below. Point out the light green line, which is the ship's track, and ask students why the ship seems to be tracking back and forth. Explain to students that the first step in the ship's exploration strategy is mapping and that the ship is obtaining high-resolution multibeam maps of the area being explored (this is called "mowing the lawn," for obvious reasons). You will see both the track of the ship and the false color bathymetry of Mytilus Seamount.

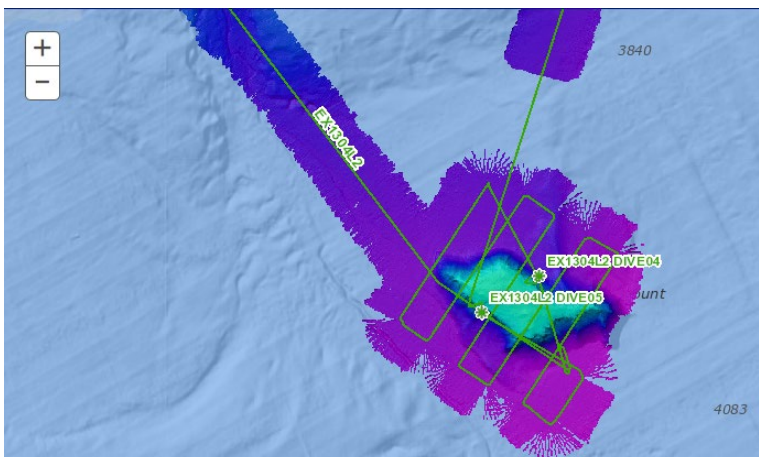

You will also see that two dives took place on the seamount, EX1304L2 Dive 4 and Dive 5.

7. Click on service.ncddc.noaa.gov/rdn/oer-waf/media/ex1304l2/EX1304L2_MytilusSeamount.scene. This will open an interactive scene file of Mytilus Seamount within a three dimensional data visualization system called Fledermaus. (This free software must be downloaded to view and manipulate the image in the figure below. See iView4D software from <http://www.qps.nl/display/main/download>).

This is an image of the Mytilus Seamount created from the multibeam sonar data collected as the ship traveled over and mapped the seafloor in this region.

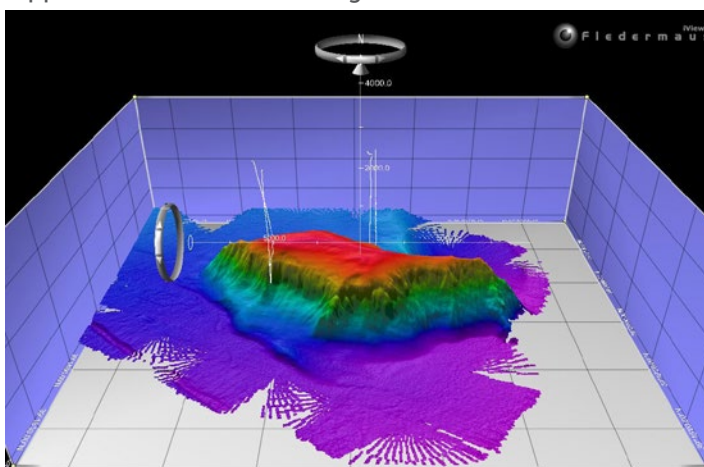

Fledermaus image of Mytilus Seamount.

8. Orientation to Fledermaus manipulation tools:

- a) Notice on the top left box that the exaggeration is set at 3.00x. The actual exaggeration is 1. The image has been exaggerated to three in order to view the structure in more detail.
- b) In the column on the left, viewers can select different views of the seamount. Checking the first box will provide a false color map of the seamount with purple being the deepest points and red being the shallowest points. Checking the second box will show the slope. Checking the final two boxes will produce vertical white lines indicating the tracks of the ROV deployed to explore the seamount.
- c) The white x and y axis orients the viewer to distance in meters.
- d) The rings on the left and at the top of the image can be used to manipulate the view. (Note: Use Camera and Reset Camera in the menu bar to return to the original view.)
- e) The ocean floor is shown as a three-dimensional image. The x-axis represents longitude, the y-axis represents latitude, and the z-axis represents depth. When you move the cursor over the image, the window near the bottom of the screen shows the geo coordinates (x, y, and z) for the location beneath the cursor.

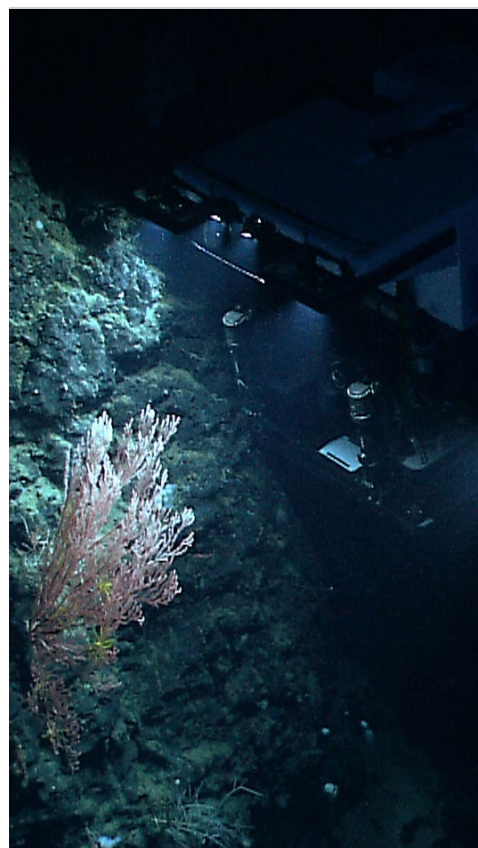

NOAA's ROV, *Deep Discoverer*, examines a deepwater coral colony on the north flank of the almost wholly unexplored Mytilus Seamount. Image courtesy of NOAA OER, 2013 Northeast U.S. Canyons Expedition. <http://oceanexplorer.noaa.gov/oceanos/explorations/ex1304/dailyupdates/media/aug4.html>

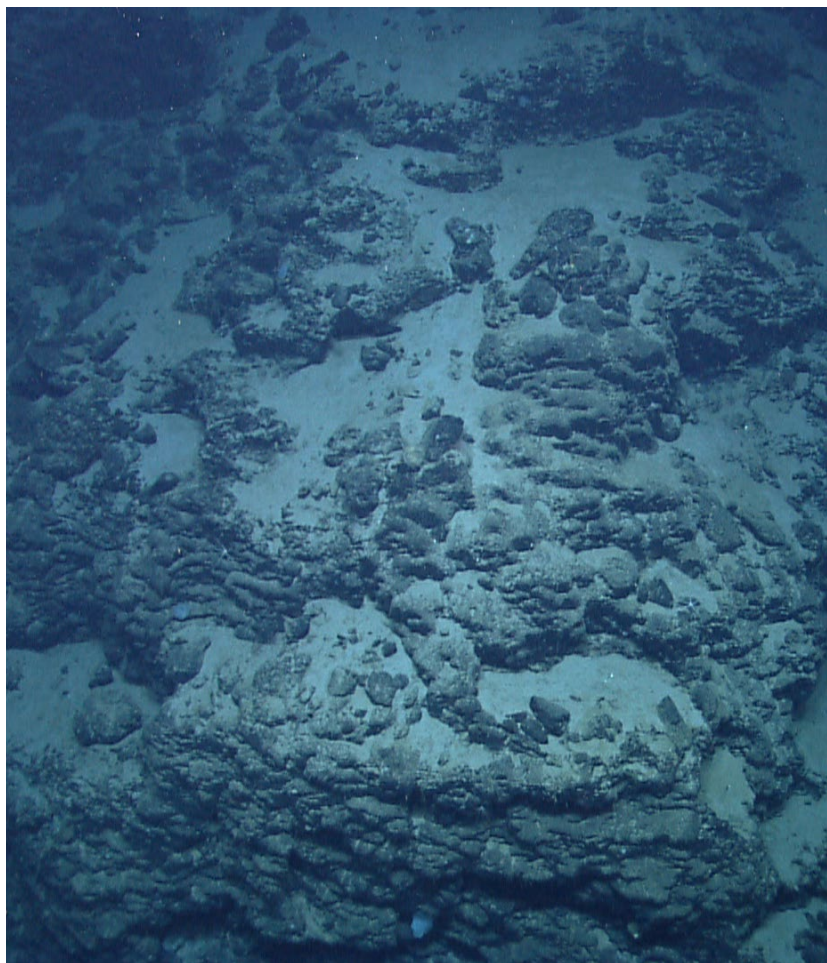

This view of steep basalt pillars on the north side of Mytilus Seamount resembles a lava flow, illustrating the seamount's volcanic origin. Image courtesy of NOAA OER, 2013 Northeast U.S. Canyons Expedition. <http://oceanexplorer.noaa.gov/oceanos/explorations/ex1304/logs/aug6/media/rocks.html>



Sponges are abundant and diverse at Mytilus Seamount. Notice this large “witch’s hat” sponge provides structure for numerous hexactinellid or glass sponges as well as some orange brittle stars. Image courtesy of NOAA OER, 2013 Northeast U.S. Canyons Expedition.

<http://oceanexplorer.noaa.gov/oceanos/explorations/ex1304/logs/aug6/media/sponge.html>



A crinoid or feather star hangs out on a deepwater coral on the south side of Mytilus Seamount. Image courtesy of NOAA OER, 2013 Northeast U.S. Canyons Expedition.

<http://oceanexplorer.noaa.gov/oceanos/explorations/ex1304/dailyupdates/media/aug5.html>

Have students analyze the image and develop questions based on their own curiosity.

Questions for students to consider might include:

- What is the length of the seamount from east to west?
- What is the length of the seamount from north to south?
- What is the deepest point of this seamount? What is the shallowest point?
- What appears to be one of the steepest point on this seamount?

Based on what they observe in the image and where they know the seamount is located:

- What might be the reason this seamount has a flat top? (Note: one theory is that this seamount was once above sea level and was worn flat by wind and weather.)
- What is the geology like at this seamount? Type of rock? Hardness of rock or sediment?
- What organisms might live here? Why?
- Do you think different organisms live at different depths on this seamount? Why or why not?
- Why did the scientists select these dive locations? If you were the scientist leading this expedition and exploring this seamount for the first time, where would you choose to send the ROV? What considerations do you think need to be made when deciding what regions to select for further exploration?
- What differences might you expect between Dive 4 on the north side of the seamount and Dive 5 on the south side of the seamount?

9. Now go back in the atlas and click on the expedition box on the right, EX1304L2, again. In the pop up window **Summary** tab will be a link to the expedition on the Ocean Explorer website. Click on **Expedition Website**.

This is the main Northeast U.S. Canyons Expedition 2013 webpage. Find and click on the Daily Updates link.

Scroll to Dives 4 (north side of the seamount) and 5 (south side of the seamount) to have students read about what was found during each of these dives.

Ask students:

Why did scientists select this seamount for exploration? (This is one of the least explored seamounts of the NE Seamount Chain.)

What was the deepest point the ROV traveled during these two dives? (3271 meters)

What is the primary type of rock present at this seamount? (basalt) Why? (The New England Seamount chain is a line of extinct volcanoes running from the southern side of Georges Bank midway across the western Atlantic.)

Why do you think there were more fish found on the south side of the seamount vs the north side? (possible food sources; possible hiding places)

10. Now that students have read the two Dive logs, discuss possible answers to some of their questions from #8.
11. Ask students if they were to take what was learned from this exploration and go back to investigate further, what would be their area of interest? What would they want to know?
Possible areas of further exploration:
Why did the basalt rocks in Dive 4 have a manganese coating?
How did pillow lava form in this location?
Why do the hermit crabs found here have anemone houses?
Why did different organisms inhabit different locations on the bamboo coral?
What are some possible food chains and food webs in this region?
Do different corals live at different depths?
Why are there different organisms on the north vs the south side of this seamount?
12. Once students have shared their interests for further exploration, have them read the following Mission Log from August 6, 2013 following the two dives locations just explored.
<http://oceanexplorer.noaa.gov/oceanos/explorations/ex1304/logs/aug6/aug6.html>

Additional Resources

Ocean Explorer Seamounts Theme page

<http://oceanexplorer.noaa.gov/edu/themes/seamounts/welcome.html>

This page compiles some of the best ocean explorer education resources on seamounts including essays, lessons, multimedia activities and links to past expeditions.

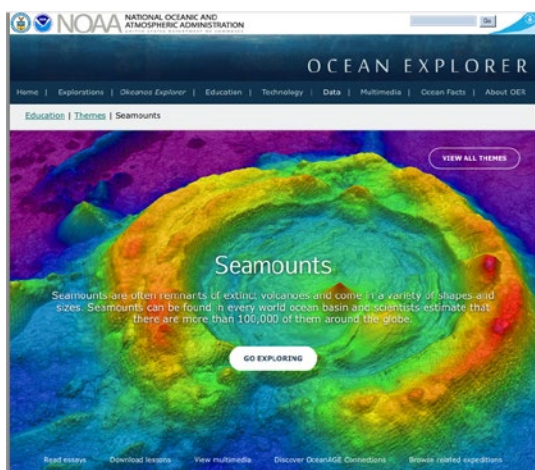

Seamounts, Les Watling Ph.D., University of Hawai'i at Manoa

<https://vimeo.com/88841596>

In this 45 minute video, Dr. Les Watling, marine scientist at the University of Hawai'i at Manoa, provides an excellent description of the formation of seamounts, their geology and their associated ecological and biological diversity.



An octopus strikes a pose for the remotely operated vehicle near Shallop Canyon. Image courtesy of NOAA OER, 2013 Northeast U.S. Canyons Expedition.

<http://oceanexplorer.noaa.gov/oceanos/explorations/ex1304/logs/aug16/aug16.html>

Information and Feedback

We value your feedback on this lesson, including how you use it in your formal/informal education settings.

Please send your comments to:
oceaneducation@noaa.gov

Acknowledgments

Design/layout: Coastal Images Graphic Design, Charleston, SC. If reproducing this lesson, please cite NOAA as the source, and provide the following URL:

<http://oceanexplorer.noaa.gov>

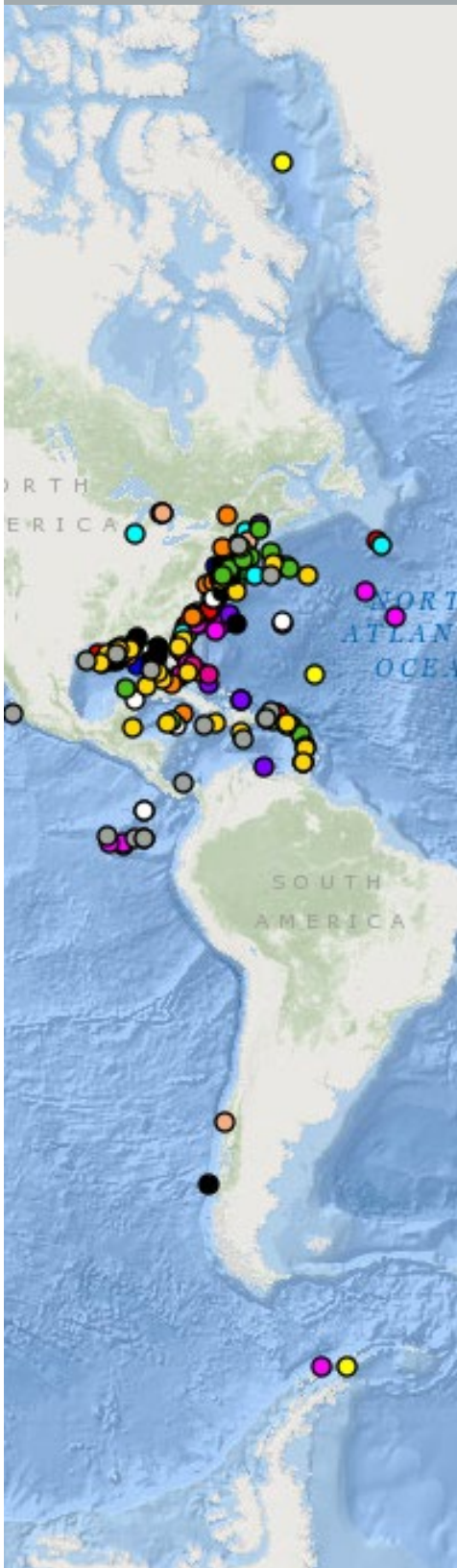

Northeast U.S. Canyons Expedition 2013: Cold Seeps

This activity illustrates how to use the Digital Atlas and how to use the Fledermaus software, and extends the Ocean Explorer Digital Atlas Supplement to explore a different location.

1. Open the Ocean Explorer Digital Atlas at http://www.ncddc.noaa.gov/website/google_maps/OE/mapsOE.htm.
2. In the left column click on the **Search by Text** tab at the bottom. In the text box type *Okeanos Explorer*. The dots that will appear on the map are all of the *Okeanos Explorer* expeditions color-coded by year.

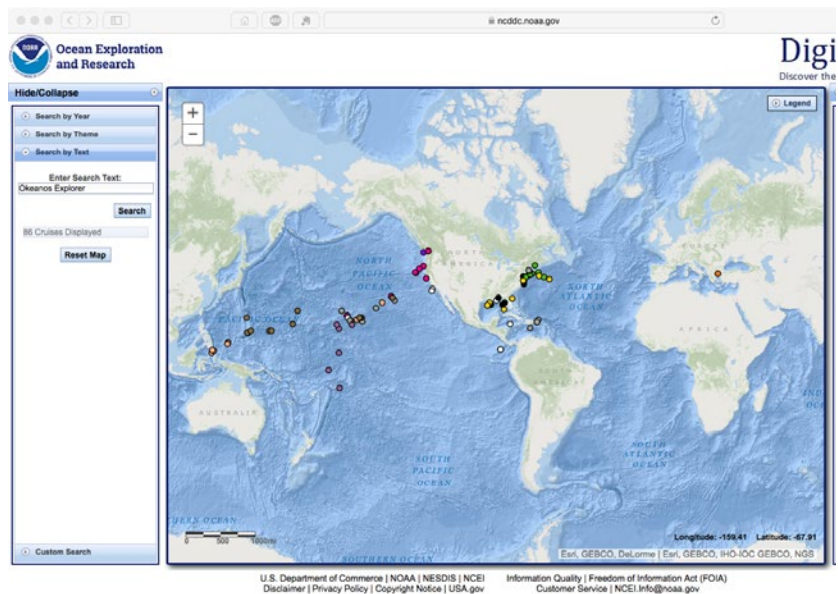

3. In the column on the right, scroll to find the 2013 *Okeanos Explorer* Northeast U.S. Canyons Expedition (EX1304L1). Tell students that cruises are named with an abbreviation of the ship name ("EX" is used as an abbreviation for *Okeanos*

A screen grab from the map on the Digital Atlas web site showing sites of Ocean Explorer cruises. The database can be searched by Expedition, Year, Theme, Text or Custom Search. https://www.ncddc.noaa.gov/website/google_maps/OE/mapsOE.htm

Explorer), the last two digits of the year in which the cruise took place ("13"), the number of the cruise (this was the fourth cruise for 2013), and the segment or leg (this was the first leg of cruise 04). Click on this cruise and you will see a pop up box as illustrated in the figure below.

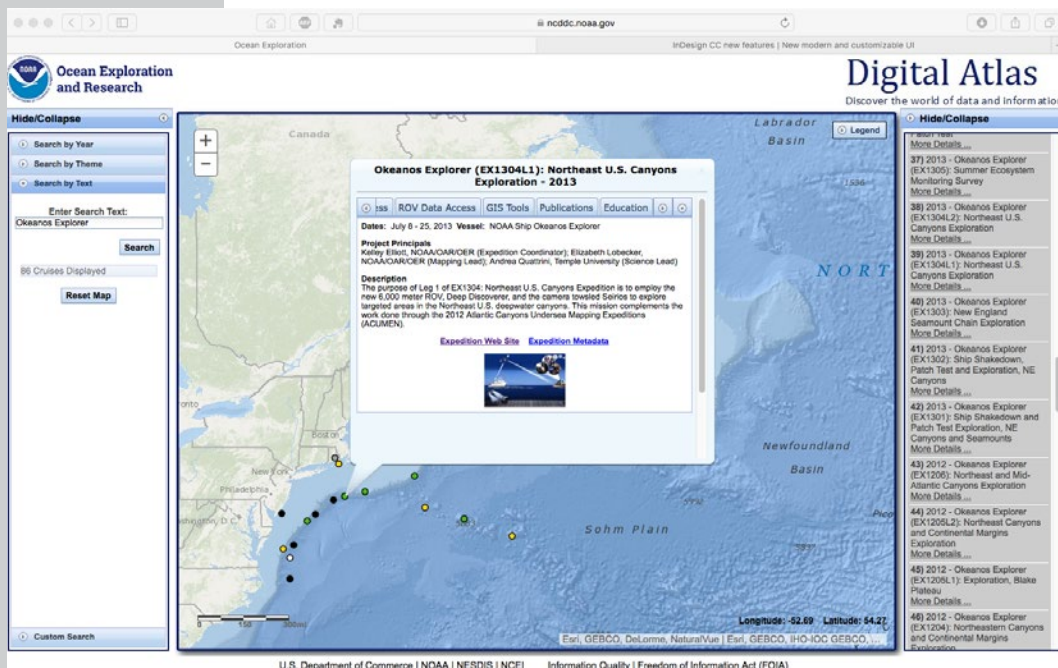

Notice the tabs provided at the top of the pop up window. For educator information related to this cruise, click on the [Education](#) tab. This will take you to several educational resources available on the Ocean Explorer website related to this expedition including an Expedition Education Module which provides background information, an introductory video, lessons and more resources associated with the expedition.

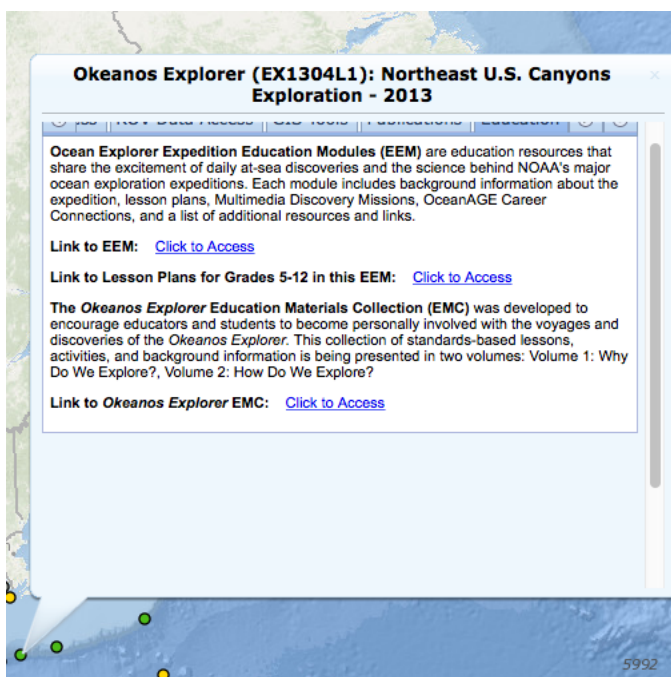

The Northeast U.S. Canyons Expedition took place during the summer of 2013. During this expedition, a team of scientists and technicians both at-sea and on shore conducted exploratory investigations on the diversity and distribution of deep-sea habitats and marine life along the Northeast U.S. Canyons and at Mytilus Seamount, located within the U.S. Exclusive Economic Zone. During this mission, the exploration team observed deep-sea coral communities, undersea canyons, seamounts and cold seeps. The 36-day expedition complemented work done through the *2012 Atlantic Canyons Undersea Mapping Expeditions (ACUMEN)* <http://oceanexplorer.noaa.gov/oceanos/explorations/acumen12/welcome.html>.

The expedition also marked the first time NOAA's new 6,000 meter remotely operated vehicle (ROV), *Deep Discoverer* <http://oceanexplorer.noaa.gov/technology/subs/deep-discoverer/deep-discoverer.html> and the *Seirios* <http://oceanexplorer.noaa.gov/oceanos/explorations/ex1708/logs/sept26/welcome.html> camera sled and lighting platform were used in a full telepresence-enabled ocean exploration with NOAA Ship *Okeanos Explorer*. When these systems were deployed from the ship, the expedition team was able to provide scientists and audiences onshore with real-time video footage from deepwater areas in important, largely unknown, U.S. waters.

- Click on the **GIS Tools** tab in the pop up window, select the first four boxes, and click **Plot on Map**. (See image at right.)

Give the map a moment to load and what appears should look like the figure below. This shows the ship's entire cruise track and the bathymetric mapping work done throughout the expedition.

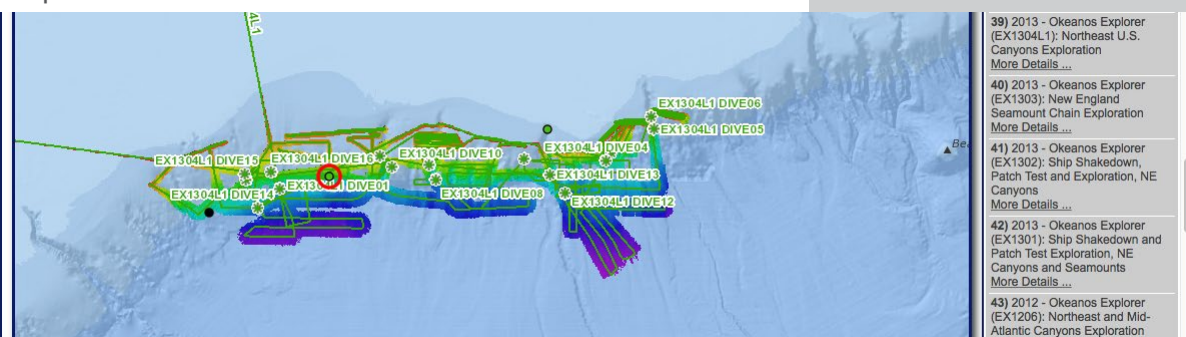

- Click on the map and holding the left cursor down, move the view slightly to the right. Zoom in until you find Dive 3 indicated with a star and EX1304L1 Dive 3.

Point out the light green line, which is the ship's track, and ask students why the ship seems to be tracking back and forth. Explain to students that the first step in the ship's exploration strategy is mapping and that the ship is obtaining high-resolution multibeam maps of the area being explored (this is called "mowing the lawn," for obvious reasons). You will see

both the track of the ship and the false color bathymetry of the mapped seafloor.

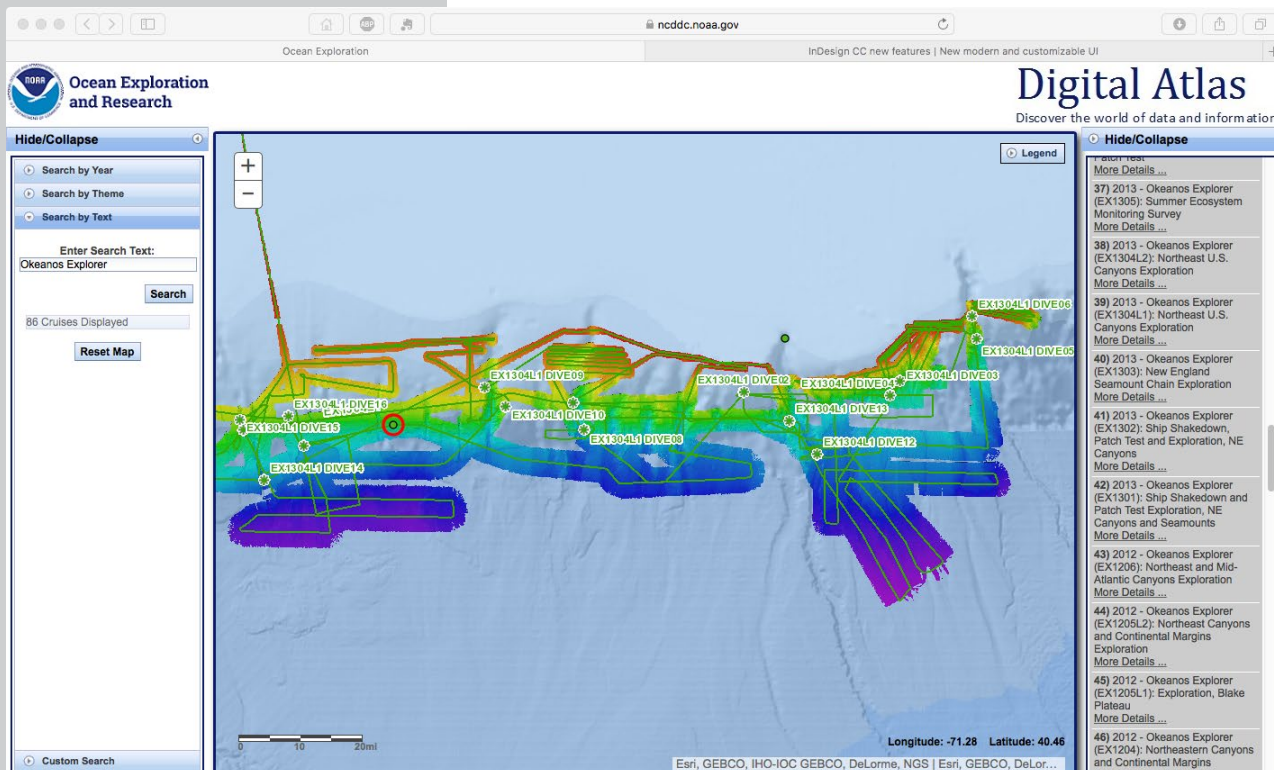

6. Click on service.ncddc.noaa.gov/rdn/oer-waf/media/ex1304l1/EX1304L1_Dive03_Seeps.scene. This will open an interactive scene file of the cold seeps found at this location within a three dimensional data visualization system called Fledermaus. (This free software must be downloaded to view and manipulate the image in the figure below.)

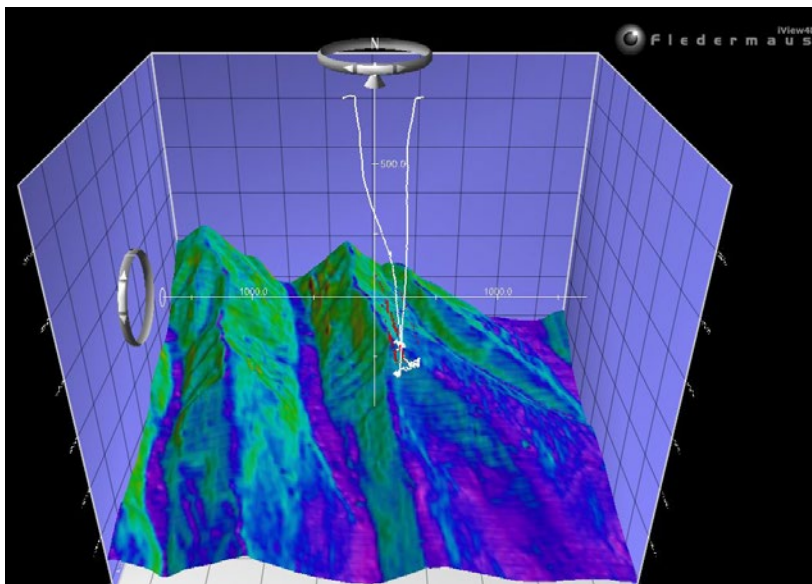

Fledermaus image of cold seeps.

7. Orientation to Fledermaus manipulation tools:
 a) Notice on the top left box that the exaggeration is set at 3.00x. The actual exaggeration is 1. The image has been

- exaggerated to three in order to view the structure in more detail.
- In the column on the left, viewers can select different views of the region being explored. Checking the first box will provide a false color map of the region with purple being the deepest points and red being the shallowest points. Checking the third box will show the slope. Checking the fourth box will show the track of the ROV. Checking the fifth and sixth boxes will reveal the bubbles from methane seeps discovered during the expedition.
 - The white x and y axis orients the viewer to distance in meters.
 - The rings on the left and at the top of the image can be used to manipulate the view. (Note: Use Camera and Reset Camera in the menu bar to return to the original view.)
 - The ocean floor is shown as a three-dimensional image. The x-axis represents longitude, the y-axis represents latitude, and the z-axis represents depth. When you move the cursor over the image, the window near the bottom of the screen shows the geo coordinates (x, y, and z) for the location beneath the cursor.

Have students analyze the image and develop questions based on their own curiosity.

Questions for students to consider might include:

- What is the deepest point in this region?
- What is the shallowest point in this region?
- What appears to be one of the steepest points in this region?
- How deep did the ROV travel when exploring this area?
- Why is the red row of bubbles leaning to the west vs. being perfectly vertical?
- What organisms might live here? Why?
- Why did the scientists select the dive locations? If you were the scientist leading this expedition and exploring this region for the first time, where would you choose to send the ROV?
- What considerations do you think need to be made when deciding what regions to select for further exploration?

- Now go back to the atlas and click on the expedition box on the right, EX1304L1, again. In the pop up window **Summary** tab will be a link to the expedition on the Ocean Explorer website. Click on **Expedition Website**. This is the main Northeast U.S. Canyons Expedition 2013 webpage. Find and click on the **Daily Updates** link. Scroll to Leg 1 Dive 3, July 11, 2013 to read about what was found during this dive. Also read the update from Dive 4 on July 12.

Have students:

- Read the updates.
- Click on the highlight videos from the ROV dives on these dates (links are under the images in each Daily Update.)

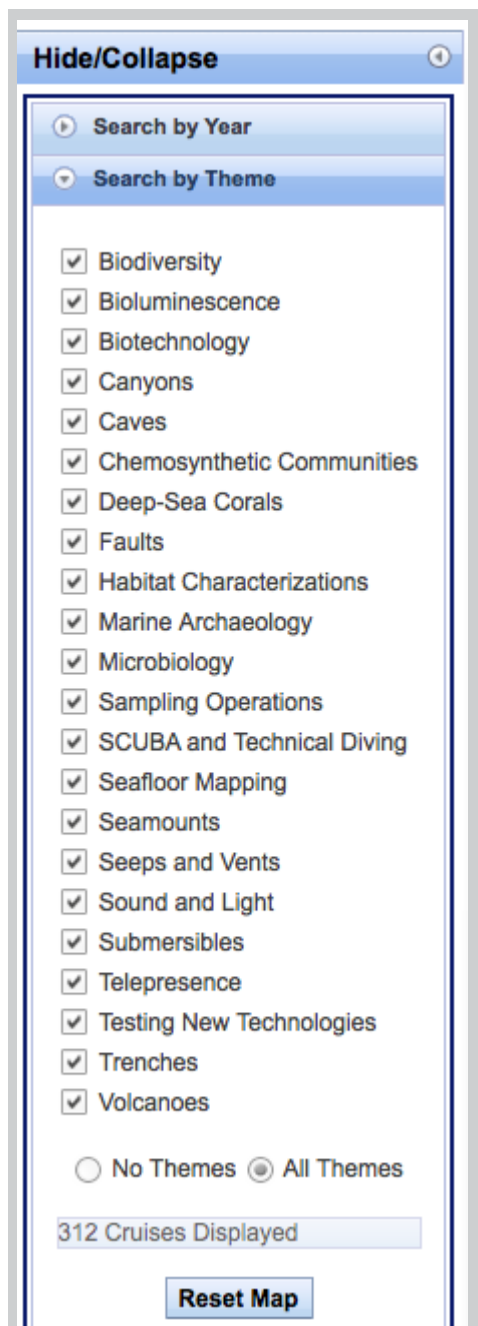

Themes that can be searched in the OER Digital Atlas.

Send Us Your Feedback

We value your feedback on this lesson, including how you use it in your formal/informal education settings. Please send your comments to: oceanexeducation@noaa.gov

Acknowledgments

Design/layout: Coastal Images Graphic Design, Charleston, SC. If reproducing this lesson, please cite NOAA as the source, and provide the following URL: <http://oceanexplorer.noaa.gov>

After reading and watching the video, ask students:

How is the *Okeanos Explorer* exploration strategy at work during this exploration? (See *Introduction to Ships of Exploration and Their Strategy for Ocean Exploration* <http://oceanexplorer.noaa.gov/okeanos/edu/collection/media/hdwe-StrategyBkgnd.pdf>)

What did you see that you would want to explore further? What would you want to know if you had the chance to go back? What was the goal of this dive?

What do the bacterial mats found tell the scientists?

How big is the methane hydrate they found (the red lasers are 10 cm apart)?

What organisms did they find during these dives?

- Have students read the background essay *Exploration of Cold Seeps on the North Atlantic Continental Margin* <http://oceanexplorer.noaa.gov/okeanos/explorations/ex1304/background/coldseeps/welcome.html> and the Mission Log from July 12, *Chemosynthetic Communities and Gas Hydrates at Cold Seeps South of Nantucket* <http://oceanexplorer.noaa.gov/okeanos/explorations/ex1304/logs/july12/july12.html> to understand the biological and global significance of the discovery of these methane seeps.

Extension

Try the lesson *What's the Big Deal?* http://oceanexplorer.noaa.gov/okeanos/edu/collection/media/wdwe_bigdeal.pdf and have students build a methane hydrate model.

Additional Resources

Skarke, A, et. al. Widespread methane leakage from the sea floor on the northern US Atlantic margin. *Nature Geoscience* 7, 657–661. Published online 24 August 2014. – An article about how methane emissions from the sea floor affect methane inputs into the atmosphere, ocean acidification and de-oxygenation, the distribution of chemosynthetic communities and energy resources. <https://www.usgs.gov/news/natural-methane-seepage-us-atlantic-ocean-margin-widespread>

Fountain, H. Methane Is Discovered Seeping From Seafloor Off East Coast, Scientists Say, *The New York Times*, Science Scientists have discovered methane gas bubbling from the seafloor in an unexpected place: off the East Coast of the United States where the continental shelf meets the deeper Atlantic Ocean. https://www.nytimes.com/2014/08/25/science/methane-is-seeping-from-seafloor-off-east-coast-scientists-say.html?_r=0



The Oceanographic Yo-yo

Focus

CTD (Conductivity, Temperature, Depth profiler), ocean chemistry and hydrothermal vents

Grade Level

6-8 (Physical Science)

Focus Question

How do ocean explorers aboard NOAA Ship *Okeanos Explorer* and other vessels of exploration use chemical clues to locate hydrothermal vents in the deep ocean?

Learning Objectives

- Students will analyze and interpret data from the *Okeanos Explorer* to make inferences about the possible presence of hydrothermal vents.
- Students will explain how interaction with hydrothermal vents affects chemical and physical properties of seawater.

Materials

- One gallon of water, chilled in a refrigerator
- Vinegar; 1 tablespoon for each student group
- A heat source (microwave oven or hot plate)
- One eyedropper
- One tablespoon
- For each student group:
 - Copy of *CTD Sample Analysis Worksheet*
 - Two thermometers
 - 5 strips wide range (approximate pH 2-9) pH paper with color chart
 - Five 100ml beakers or plastic cups labeled A, B, C, D, and E

Audiovisual Materials

- Video projector or large screen monitor for showing downloaded images (see Learning Procedure, Step 2)

A closeup of a Conductivity, Temperature, Depth profiler (CTD), the primary tool used to map hydrothermal plumes. A ring of plastic sampling bottles surrounds the CTD, which is housed in the steel container in the center of the rosette. CTD sensors are visible at the bottom of the pressure case. Image courtesy of NOAA Vents Program.

http://oceanexplorer.noaa.gov/explorations/12fire/background/hires/ctd_closeup_hires.jpg

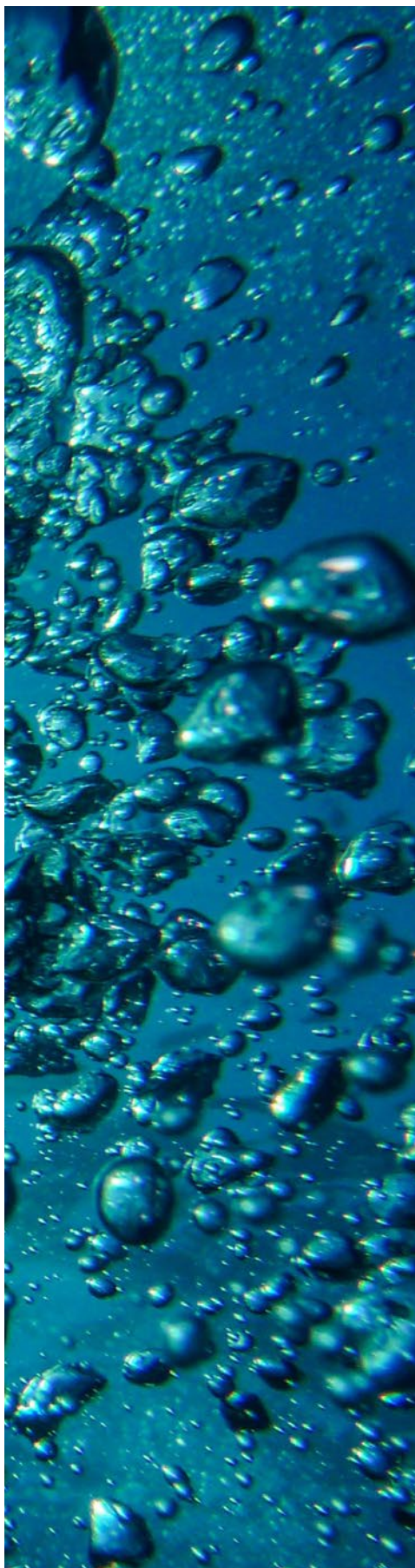

Teaching Time

Two 45-minute class periods

Seating Arrangement

Groups of three to four students

Maximum Number of Students

30

Key Words and Concepts

Ocean Exploration

Okeanos Explorer

CTD

Conductivity

pH

Hydrothermal vent

Plume

Background Information

The “water column” extends from the ocean surface to the seafloor. The water column usually refers to the volume of water underlying a specific area of Earth’s ocean. In the broadest sense, the water column may mean the entire volume of water in the ocean, from coast to coast. Because the ocean covers 71% of Earth’s surface with an average depth of nearly 4 km, the water column is the largest habitat for life on this planet. A variety of technologies are used to explore the water column, including nets and other devices to capture living organisms, sonar, and underwater vehicles (please see the *Introduction to Water Column Investigations* <http://oceanexplorer.noaa.gov/okeanos/edu/collection/media/hdwe-WCIntro.pdf> for additional details).

A CTD is water column exploration technology that includes a package of electronic devices that measure conductivity, temperature, and depth. Devices to measure other parameters also may be included, but the package is still called a CTD. Conductivity is a measure of how well a solution conducts electricity and is directly related to salinity, which is the concentration of salt and other inorganic compounds in seawater. Salinity is one of the most basic measurements used by ocean scientists. When combined with temperature data, salinity measurements can be used to determine seawater density, which is a primary driving force for major ocean currents. CTDs are often attached to a much larger metal frame called a rosette, which may hold water sampling bottles that are used to collect water at different depths, as well as other instruments. For additional details about CTDs, please see the *Introduction to Water Column Investigations* <http://oceanexplorer.noaa.gov/okeanos/edu/collection/media/hdwe-WCIntro.pdf>.

Temperature measurements from CTD sensors can be used to detect changes in water temperature that may indicate the

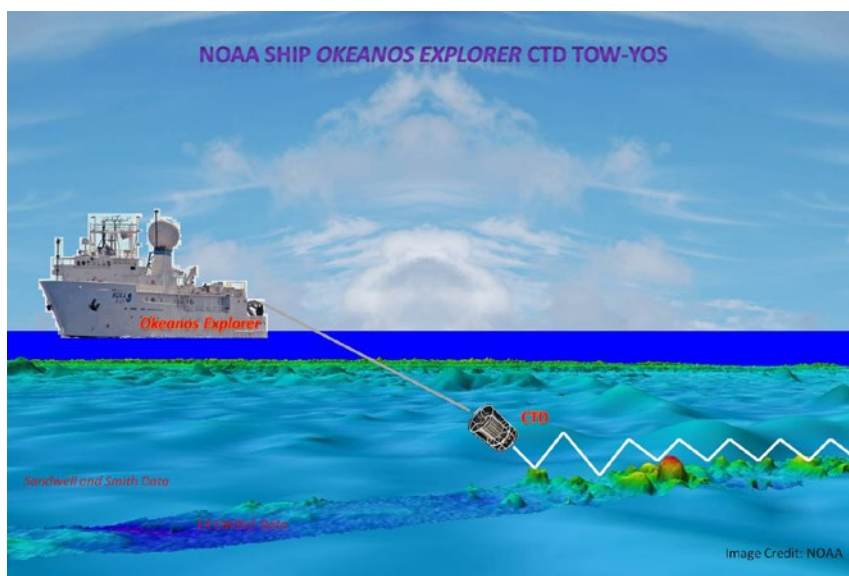

This image demonstrates the concept of a CTD Tow-Yo. The CTD is lowered to within 20 meters of the seafloor, and then is cycled between near-bottom and 300 meters above the seafloor (like a yo-yo) as it is towed behind the ship. Sensor data is recorded and monitored continuously to look for signs that plumes from hydrothermal vents are present. Image courtesy of NOAA OER.

http://oceanexplorer.noaa.gov/okeanos/explorations/ex1103/logs/hires/tow_yo_diagram_hires.jpg

presence of underwater volcanoes or hydrothermal vents. Masses of seawater with unusual characteristics are called plumes, and are usually found within a few hundred meters of the ocean floor. Since underwater volcanoes and hydrothermal vents may be several thousand meters deep, ocean explorers often raise and lower a CTD rosette from just above the seafloor to several hundred meters near the bottom as the ship slowly cruises over the area being surveyed. This repeated up-and-down motion of the towed CTD may resemble the movement of a yo-yo; a resemblance that has led to the nickname “tow-yo” for this type of CTD sampling.

This lesson introduces students to simple analysis of CTD data as a method for finding underwater volcanoes and hydrothermal vents.

Learning Procedure

1. To prepare for this lesson:
 - a) Review background information on CTD technology at
 - <http://www.pmel.noaa.gov/vents/PlumeStudies/WhatIsACTD/CTDMethods.html>;
 - <http://oceanexplorer.noaa.gov/explorations/14fire/logs/december04/december04.html#dec4-video9>; and
 - http://oceanexplorer.noaa.gov/explorations/16arctic/logs/video/ctd/ctd_video.html
 Decide whether you want to use one or both of these videos during introductory instruction in Step 2.
 - b) Review the *Introduction to Ships of Exploration and Their Strategy for Ocean Exploration* <http://oceanexplorer.noaa.gov/okeanos/edu/collection/media/hdwe-StrategyBkgnd.pdf>.
 - c) If students are not familiar with deep-sea chemosynthetic communities, you may want to use Multimedia Discovery Mission Lesson 5, Chemosynthesis and Hydrothermal Vent

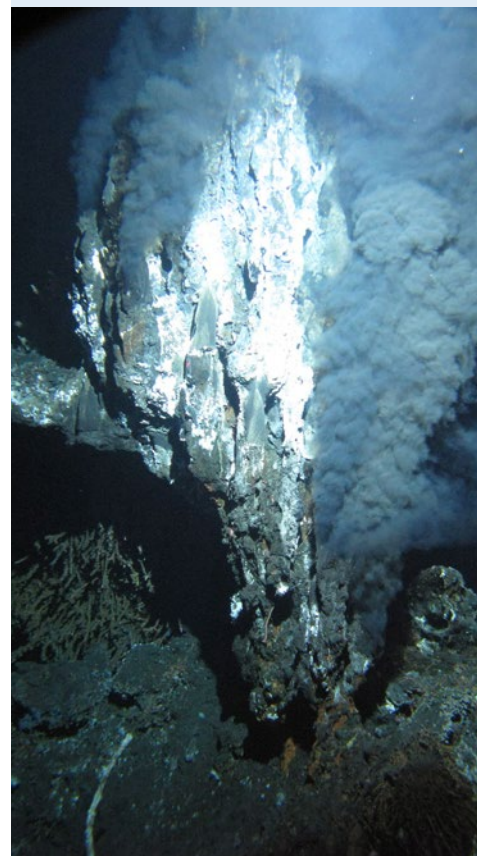

A black smoker chimney named ‘Boardwalk’ emitting 644°F (340°C) hydrothermal fluids in the northeastern Pacific Ocean at a depth of 7,260 feet (2,200 m). Microbes grow within and on the surface of such mineral formations. Image courtesy of James F. Holden, UMass Amherst.

http://oceanexplorer.noaa.gov/okeanos/explorations/10index/background/microbes/media/boardwalk_black_smoker.html

Exploring the Deep Ocean with NOAA



Water samples are collected from the Niskin bottles on the CTD. All 20 Niskin bottles take water samples from various depths, starting near the seafloor and ending close to the surface. Photo courtesy of Caitlin Bailey, GFOE, The Hidden Ocean 2016: Chukchi Borderlands.

<http://oceanexplorer.noaa.gov/explorations/16arctic/logs/july24/media/shipton.html>



Remotely operated vehicle *Deep Discoverer* being recovered after a dive. Image courtesy of NOAA OER, 2016 Deepwater Exploration of the Marianas.

<http://oceanexplorer.noaa.gov/oceanos/explorations/ex1605/logs/may1/media/1605rovrecovery.html>



Scientist Scott France participates in the dives from his home office via telepresence. Image courtesy of NOAA OER, 2016 Deepwater Exploration of the Marianas.

<http://oceanexplorer.noaa.gov/oceanos/explorations/ex1605/logs/jun28/media/1605scott-france.html>

Life (<http://oceanexplorer.noaa.gov/edu/learning/welcome.html>), and/or information from <http://www.pmel.noaa.gov/vents/nemo/explorer.html>.

- d) Review procedures for the simulated analysis of CTD samples (Step 4). Prepare materials for this activity:
 - 1) Chill one gallon of water overnight in a refrigerator.
 - 2) For each group of four students, fill five 100ml beakers or plastic cups with chilled water and label each with an A, B, C, D and E.
 - 3) Heat the water in all beakers or plastic cups labeled D for 60 seconds in the microwave oven about 15 minutes before the start of class. The water should be above 50°C, but not boiling.
 - 4) Add 3 drops of vinegar to all beakers or plastic cups labeled C and E and stir.
 - 5) Add one tablespoon of vinegar to all beakers or plastic cups labeled D and stir.
- e) If desired, download images referenced in Step 2.

2. Briefly introduce the ships of exploration NOAA Ship *Okeanos Explorer*, E/V *Nautilus*, and R/V *Falkor*; the *Introduction to Ships of Exploration and Their Strategy for Ocean Exploration* <http://oceanexplorer.noaa.gov/oceanos/edu/collection/media/hdwe-StrategyBkgnd.pdf>; and the 2017 Discovering the Deep: Exploring Remote Pacific MPAs Expedition <http://oceanexplorer.noaa.gov/oceanos/explorations/ex1703/background/plan/welcome.html>.

Briefly discuss why this kind of exploration is important (for background information, please see the lesson, *To Boldly Go* http://oceanexplorer.noaa.gov/oceanos/edu/collection/media/wdwe_toboldlygo.pdf). Highlight the overall exploration strategy used by ships of exploration, including the following points:



The NOAA Ship *Okeanos Explorer*, America's ship for ocean exploration. Image courtesy NOAA. <http://oceanexplorer.noaa.gov/oceanos/explorations/ex1702/logs/mar1/media/oceanos.html>

- The overall strategy is to develop baseline information about the biological, geological, and water chemistry features of unexplored areas to provide a foundation for future exploration and research.
- This information includes
 - High resolution maps of the area being explored, as well as areas that the ship crosses while underway from one location to the next (underway reconnaissance);
 - Exploration of water column chemistry and other features; and
 - High definition close-up video of biological and geological features in the exploration area (site characterization).
- This strategy relies on four key technologies:
 - Multibeam sonar mapping system and other types of sonar that can detect specific features in the water column and on the seafloor;
 - Conductivity, Temperature, and Depth profilers (CTD) and other electronic sensors to measure chemical and physical seawater properties;
 - A Remotely Operated Vehicle (ROV) capable of obtaining high-quality imagery and samples in depths as great as 6,000 meters; and
 - Telepresence technologies that allow scientists with many different areas of expertise to observe and interact with exploration activities, though they may be thousands of miles from the ship.

You may want to show some or all of the images in the sidebars to accompany this review.

Show an image of a CTD, and explain that this is actually a collection of several electronic instruments that measure various things about seawater. The basic instruments

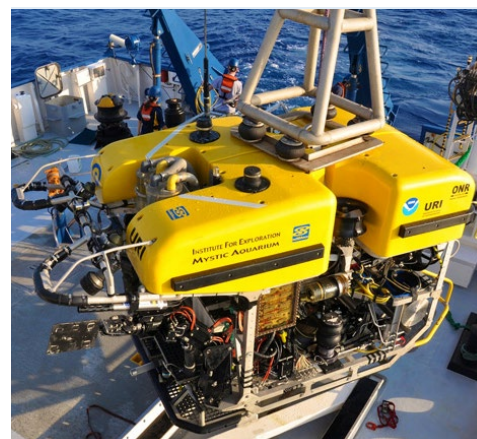

Hercules is one of the very few Remotely Operated Vehicles (ROV) specifically designed to be used as a scientific tool. Built for the Institute For Exploration (IFE), *Hercules* is equipped with special features that allow it to perform intricate tasks while descending to depths of 4,000 meters (2.5 miles).
<http://oceanexplorer.noaa.gov/technology/subs/hercules/hercules.html>



Argus (right) acts as a stabilizing platform for *Hercules*, following the ROV into the water. Image courtesy of The Ocean Exploration Trust.
<http://oceanexplorer.noaa.gov/technology/subs/hercules/argus.html>

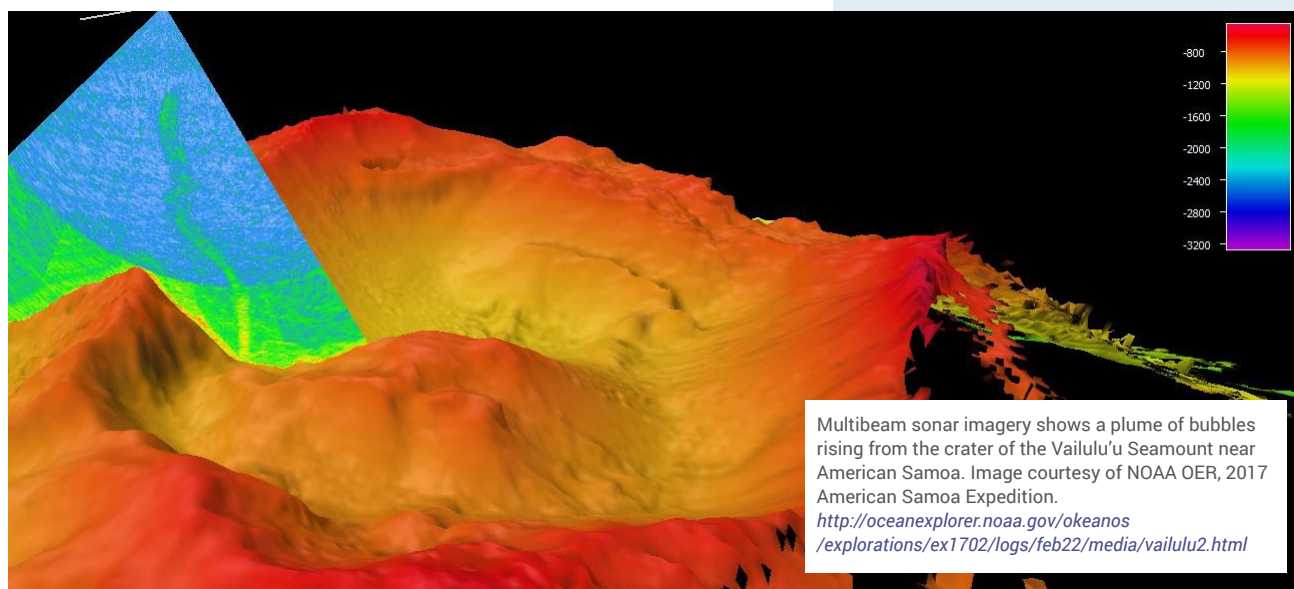

Multibeam sonar imagery shows a plume of bubbles rising from the crater of the Vailulu'u Seamount near American Samoa. Image courtesy of NOAA OER, 2017 American Samoa Expedition.
<http://oceanexplorer.noaa.gov/oceanos/explorations/ex1702/logs/feb22/media/vailulu2.html>

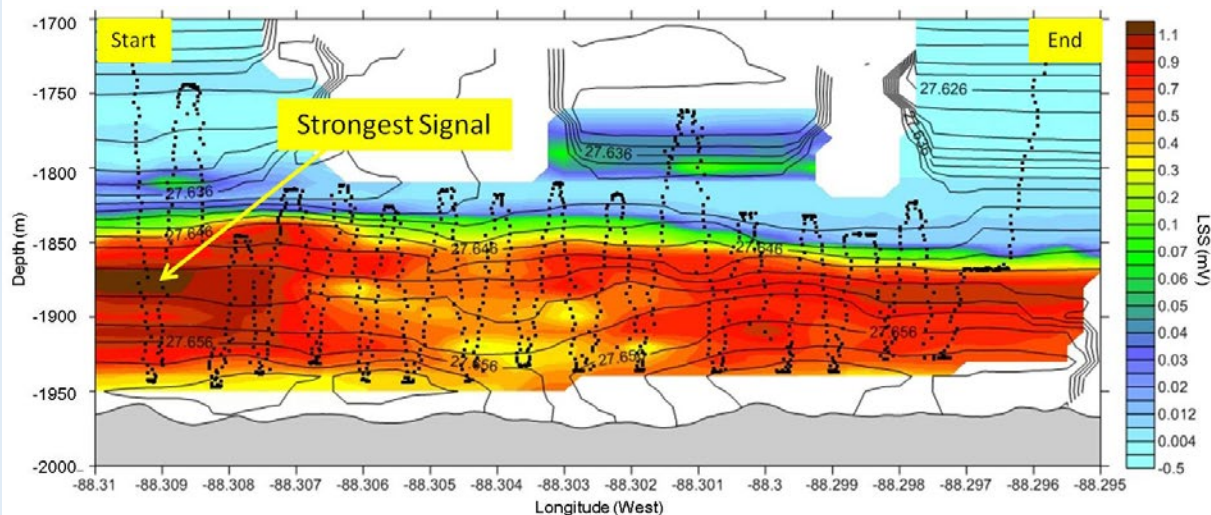

Above is a plot of the data from a CTD tow. The x axis displays the longitude of the tow, the vertical axis is depth, and the shading along the tow is the Light Scattering Sensor data. The dark patch on the left (beginning of tow) is the strongest plume signal. Image courtesy of NOAA OER.

http://oceanexplorer.noaa.gov/oceanos/explorations/ex1103/logs/hires/tow01_results_diagram_hires.jpg



Image of hydrothermal vents found during an ROV dive on Kawio Barat volcano. The yellow deposits are molten sulfur. Multiple species of hot-vent shrimp are also visible. Image courtesy of NOAA OER, INDEX-SATAL 2010.

http://oceanexplorer.noaa.gov/oceanos/explorations/10/index/logs/dailyupdates/media/june30_update.html

measure temperature, depth, and conductivity. Most of the device seen in the image is a water sampling device called a rosette or carousel, that contains water sampling bottles that are used to collect water at different depths. Before the rosette is lowered into the ocean, the bottles are opened so that water flows freely through them. As the rosette travels through the water column, scientists can monitor readings from the CTD sensors. If something unusual appears in the measurements, the scientists can send a signal through the CTD cable that closes one or more of the bottles to collect a water sample from the location where the unusual measurements appeared.

If students are not familiar with deep-sea chemosynthetic communities, briefly describe the concept of chemosynthesis, and contrast it with photosynthesis. Tell students that chemosynthetic ecosystems in the deep ocean are found where a source of chemical energy is emerging from the ocean floor. If you have decided to use materials referenced in Step 1c, present these now. Tell students that a major objective of ocean exploration is to locate submarine volcanoes, hydrothermal vents, chemosynthetic ecosystems, and seamounts as these are often associated with active geologic processes and highly productive biological communities in Earth's deep ocean.

3. Discuss some of the clues that might result from the interaction of hydrothermal vents with seawater. Increased temperature is fairly obvious, since heat from Earth's core is the energy source that causes vents to form. Temperatures of hydrothermal fluids may be more than 300°C, since the high pressure of deep-sea environments prevents water from boiling. Fluids from hydrothermal vents are often highly acidic, in contrast to normal seawater which is slightly basic; so pH is another potential clue. You may need to explain that pH is a measure of the concentration of hydrogen ions. For a more

detailed discussion about pH, please see “More About pH” in the lesson, *To Boldly Go*. Hydrogen sulfide is often found in hydrothermal vent fluids, but is not normally found in seawater. So a chemical analysis that indicates its presence in a seawater sample would be another clue that signals vents may be nearby.

- The following activity simulates an analysis of water samples collected by a CTD. Tell students that their assignment is to analyze several samples collected by a CTD to determine whether any of the samples suggest that they might have been collected from a location near a hydrothermal vent. Demonstrate the correct way to measure pH with a pH strip if students are not already familiar with this procedure.

Provide each student group with two thermometers, 5 strips of pH paper, a pH color indicator chart, a CTD Sample Analysis Worksheet, and samples A, B, C, D and E. Tell students to make measurements needed to complete the worksheet on page 10 and to plot the CTD data on the graphs provided on pages 11-12.

Be sure students understand that the grids provided for their graphs have zero at the TOP of the y-axis. This is because oceanographers like to plot CTD data with depth on the y-axis and the greatest depths at the bottom of the plot, since that is the way we usually think about a profile of the water column.

- Discuss students’ results. Students should infer that sample D may have been collected in the vicinity of a hydrothermal vent, since its temperature is noticeably higher than that of the other samples, and its pH is noticeably lower. Ask students what other measurements might be made to support this inference. These might include chemical analysis to detect the presence of substances associated with hydrothermal vents, such as hydrogen sulfide.

Students’ graphs of CTD data should resemble Figures 1, 2, and 3. Students should recognize that Figure 1 is different from the others, in that water temperature increases near the bottom (even a small increase is significant). Since this is not what would ordinarily be expected, it may be a signal that something unusual is happening in this area! In fact, this CTD cast was made in the vicinity of an active hydrothermal vent. The next day, *Okeanos Explorer’s* ROV visited the site and found an active hydrothermal vent “surrounded by yellow and black molten sulfur, multiple species of hot-vent shrimp, a 10 cm scale worm, and a small patch of stalked barnacles. After departing from the vent, the ROV ascended the summit ridge and encountered fields of sulfide chimneys with vast aggregations of stalked barnacles at their base. The chimneys varied in terms of age and venting characteristics. Some

Figure 1.

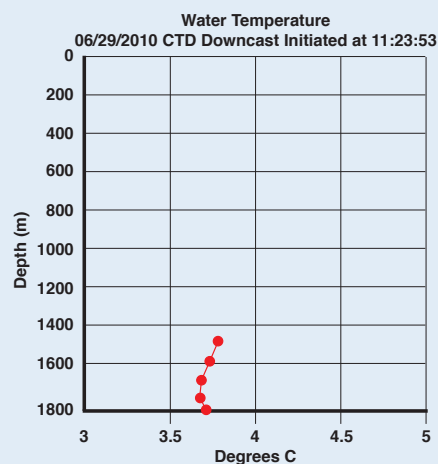

Figure 2.

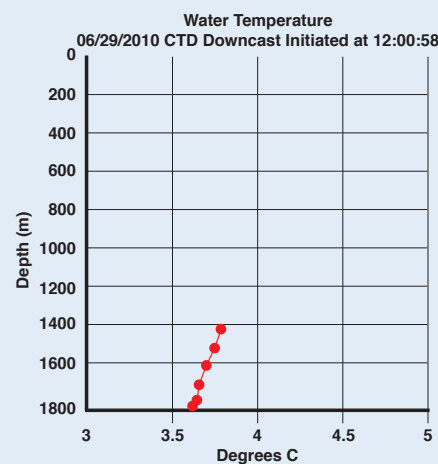
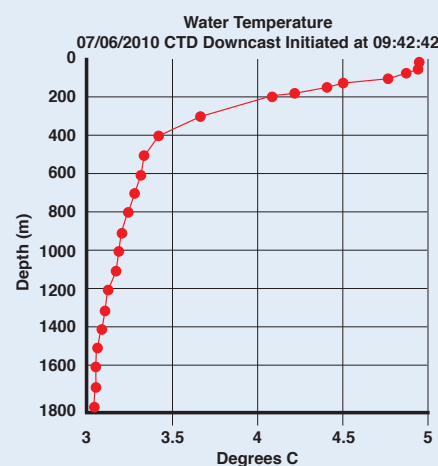

Figure 3.



Note: Graphs of temperature and other CTD data collected during *Okeanos Explorer* cruises in 2010.



chimneys were fairly oxidized and others covered in white sulfide. Some chimneys were venting clear fluid while others were venting black smoke." You can read more about the site, and see images from the ROV dive here: <http://oceanexplorer.noaa.gov/oceanos/explorations/10index/logs/june30/june30.html>.

Point out that this is an excellent example of the interdependence of science, engineering, and technology. The instrument technologies produced by engineering made it possible to make measurements that detected an anomaly. Other technologies made it possible to investigate the anomaly and provide scientific data from a new hydrothermal vent site.

The BRIDGE Connection

www.vims.edu/bridge/ – Scroll over “Ocean Science Topics” in the menu on the left side of the page, then “Human Activities,” then click on “Habitats” then select “Deep Ocean” for activities and links about deep ocean ecosystems.

The “Me” Connection

Have students visit <http://oceanexplorer.noaa.gov/oceanos/explorations/ex1605/logs/welcome.html>, which is the Mission Logs page for the 2016 Deepwater Exploration of the Marianas expedition, select one entry that seems interesting, and write a brief essay about what job they would like to have if they were personally aboard the ship.

Connections to Other Subjects

English Language Arts, Social Studies, Mathematics

Assessment

Class discussions and students’ work with the charting activity provide opportunities for assessment.

Extensions

Visit the Web page <http://oceanexplorer.noaa.gov/oceanos/welcome.html> for reports, images, and other products from *Oceanos Explorer* cruises.

Multimedia Discovery Missions

<http://www.oceanexplorer.noaa.gov/edu/learning/welcome.html>
Click on the links to Lessons 1, 5 and 6 for interactive multimedia presentations and Learning Activities on Plate Tectonics, Chemosynthesis and Hydrothermal Vent Life, and Deep-Sea Benthos.

Hydrothermal-vent chimney. Look closely, and you will also see the chimney is crawling with *Chorocaris* shrimp and *Austinograea williamsi* crabs. Image courtesy of NOAA OER, 2016 Deepwater Exploration of the Marianas.
<http://oceanexplorer.noaa.gov/oceanos/explorations/ex1605/dailyupdates/media/may2.html>

Other Relevant Lessons from NOAA OER**A Hydrothermal AdVENTure**

<http://oceanexplorer.noaa.gov/explorations/10chile/background/edu/media/ahydrothermal.pdf>

Focus: Hydrothermal vents (Grades 5-6; Earth Science)

Students explain the overall structure of hydrothermal vents and how they are related to the motion of tectonic plates, and create a model of a hydrothermal vent.

The Tell-Tale Plume

<http://oceanexplorer.noaa.gov/explorations/10chile/background/edu/media/plume.pdf>

Focus: Hydrothermal Vent Chemistry (Grades 9-12; Chemistry, Earth Science)

Students describe hydrothermal vents, identify changes that they cause to the physical and chemical properties of seawater, and use oceanographic data to recognize a probable plume from hydrothermal activity.

Next Generation Science Standards and Ocean Literacy Essential Principles and Fundamental Concepts

This lesson supports the Ocean Literacy Essential Principles and Fundamental Concepts as indicated here <http://oceanexplorer.noaa.gov/oceanos/edu/collection/media/hdwe-Standards.pdf>. Additionally, while it is not intended to target specific Next Generation Science Standards, activities in this lesson may be used to address some Science and Engineering Practices and Crosscutting Concepts. These include:

Science and Engineering Practices

- Defining problems (for engineering)
- Developing and using models
- Analyzing and interpreting data
- Using mathematics and computational thinking
- Constructing explanations
- Engaging in argument from evidence
- Obtaining, evaluating, and communicating information

Crosscutting Concepts

- Patterns
- Cause and effect
- Systems and system models
- Stability and change

For Information and Feedback

We value your feedback on this lesson, including how you use it in your formal/informal education settings. Please send your comments to: oceanexeducation@noaa.gov

Acknowledgments

Produced by Mel Goodwin, PhD, Marine Biologist and Science Writer, Charleston, SC. Design/layout: Coastal Images Graphic Design, Charleston, SC. If reproducing this lesson, please cite NOAA as the source, and provide the following URL: <http://oceanexplorer.noaa.gov>

**The Next Generation Science Standards**

The Next Generation Science Standards integrate three dimensions within each standard: Science and Engineering Practices, Disciplinary Core Ideas, and Crosscutting Concepts. The standards are written as student performance expectations. While specific performance expectations may emphasize only a few of the practice categories, teachers are encouraged to utilize several practices in any instruction. Similarly, only a few crosscutting concepts may be emphasized, but this is not intended to limit instruction.



CTD Sample Analysis Worksheet

Group Name: _____

Sample	Temperature	pH
--------	-------------	----

A	_____	_____
---	-------	-------

B	_____	_____
---	-------	-------

C	_____	_____
---	-------	-------

D	_____	_____
---	-------	-------

E	_____	_____
---	-------	-------

1. Do the data in the table above suggest that any of these samples might have been collected near a hydrothermal vent?

2. How do your data support this inference?

3. Here are some data from CTD casts made aboard the *Okeanos Explorer* during the INDEX-SATAL 2010 Expedition (these are just a few of the data points provided by the CTD instruments; the complete data sets contain thousands of points!). Plot these points on the grids. Do any of your graphs show any possible anomalies?

06/29/2010

CTD Downcast Initiated at 11:23:53

Depth (m)	Water Temperature (°C)
1450	3.8
1600	3.75
1680	3.6
1750	3.6
1800	3.7

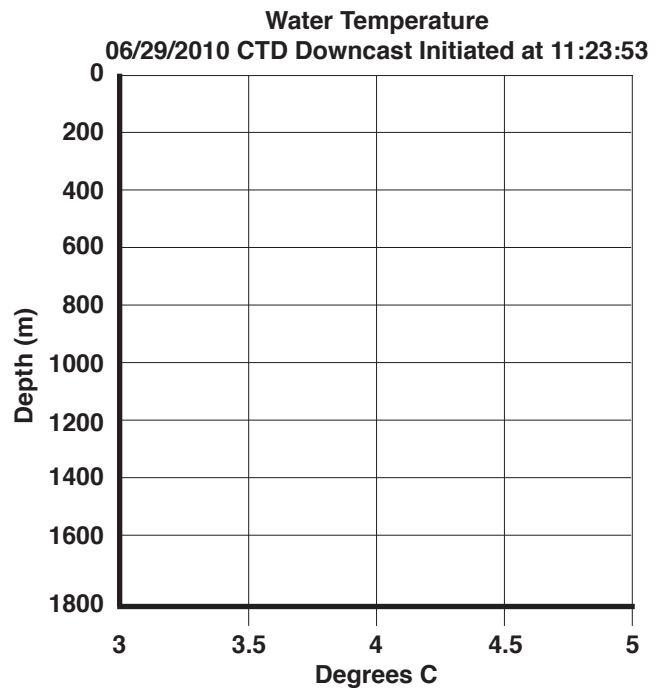

06/29/2010

CTD Downcast Initiated at 12:00:58

Depth (m)	Water Temperature (°C)
1400	3.8
1500	3.75
1600	3.7
1700	3.67
1750	3.65
1800	3.6

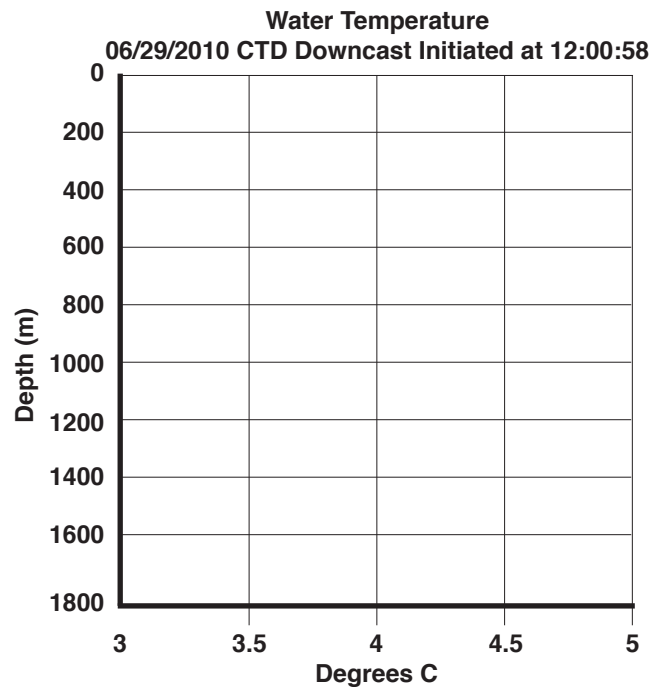



07/06/2010
CTD Downcast Initiated at 09:42:42

Depth (m)	Water Temperature (°C)
10	4.95
50	4.9
80	4.85
100	4.8
150	4.5
175	4.4
190	4.2
200	4.1
300	3.7
400	3.4
500	3.35
600	3.32
700	3.30
800	3.25
900	3.20
1000	3.175
1100	3.16
1200	3.15
1300	3.12
1400	3.10
1500	3.08
1600	3.07
1700	3.06
1800	3.05

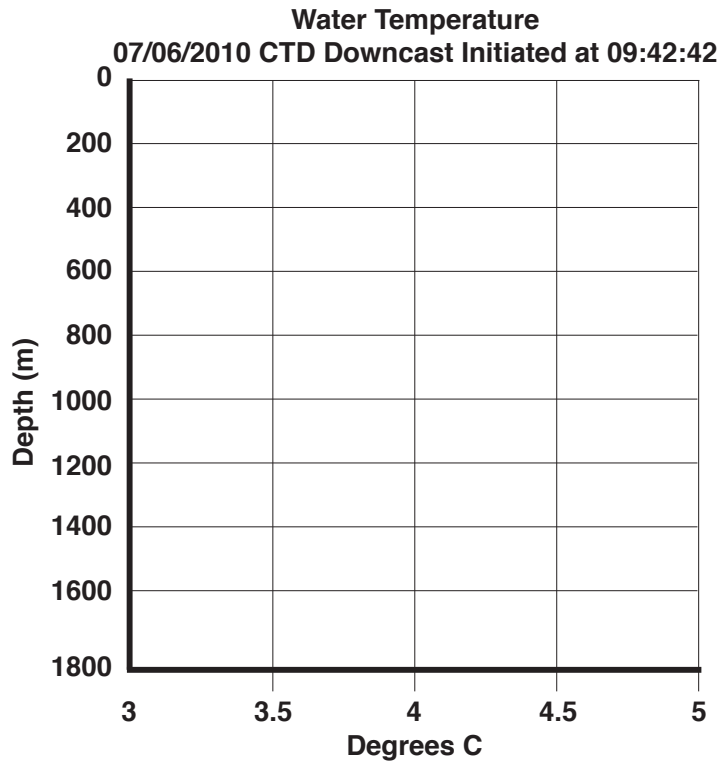

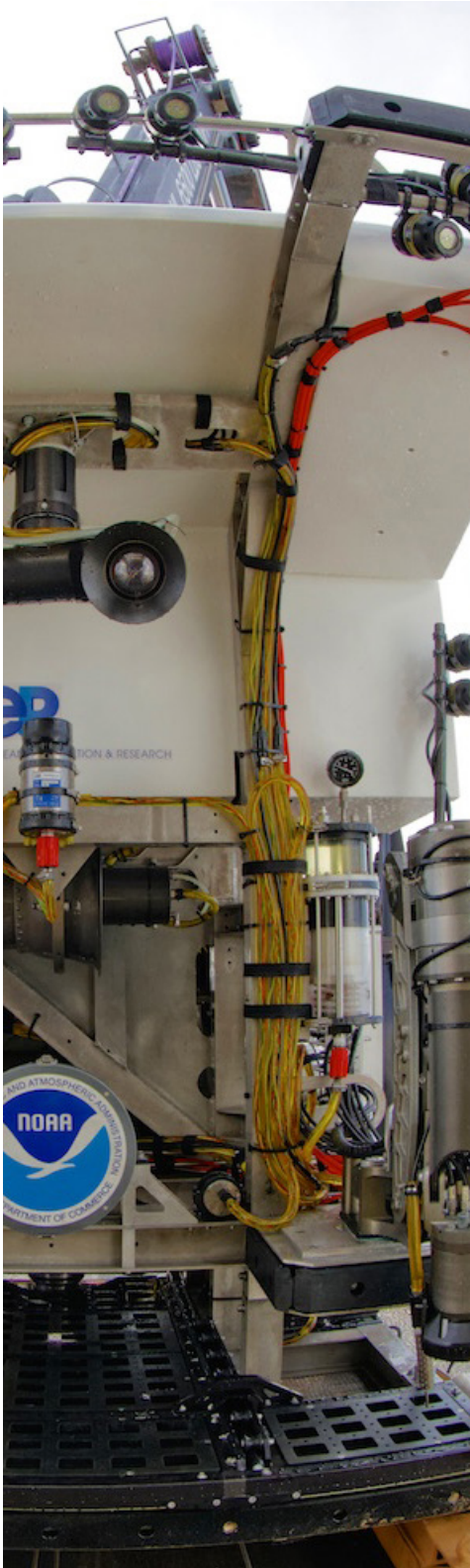

Invent a Robot!

Focus

Engineering design

Grade Level

6-8 (Physical Science/Technology)

Focus Question

How can scientists design and build robotic arms that are capable of specific movements?

Learning Objectives

- Students will explain how underwater robots are used in scientific exploration to gather data and help answer questions about the natural world.
- Students will design and optimize potential solutions for an ocean exploration problem.

Materials

For each student group:

- Copy of *Student Worksheet*
- Five pieces of cardboard or heavy poster board, each approximately 12" x 12" (the stiffer the better)
- Duct tape, approximately 2" x 80'
- 10 - Machine screws with nuts, #8 x 1"
- 4 - Machine screws with nuts, #8 x 3"
- 21 - Flat washers, #8 hole
- 4 - Oral syringes
- Two pieces of plastic tubing, approximately 3/16" inside diameter; each approximately 12" long (should fit snugly over the end of the syringes)
- Water
- Small container, such as a 9-oz drinking cup

Tools (may be shared by several student groups)

- Heavy scissors to cut cardboard ("bandage scissors" are inexpensive and work well)
- Nail or Phillips screwdriver to punch holes in cardboard
- Screwdriver to fit the slot size and shape of the machine screws

Close up of the remotely operated vehicle (ROV) *Deep Discoverer*. Image courtesy of NOAA OER, Gulf of Mexico 2014 Expedition.

<http://oceanexplorer.noaa.gov/oceanos/explorations/ex1402/logs/apr15/media/drfront.html>



Another day at the office for the ROV pilot. Image courtesy of NOAA OER, 2017 Laulima O Ka Moana. <http://oceanexplorer.noaa.gov/oceanos/explorations/ex1706/logs/july15/welcome.html>

Audiovisual Materials

- Video projector or large screen monitor for showing downloaded images (see Learning Procedure, Step 1d)

Teaching Time

Two or three 45-minute class periods, plus time for students to construct their robotic arm

Seating Arrangement

Groups of two to four students

Maximum Number of Students

30

Key Words and Concepts

- Ocean Exploration
- Okeanos Explorer*
- Robot
- Remotely operated vehicle
- Engineering design

Background Information

The site characterization component of NOAA Ship *Okeanos Explorer's* exploration strategy depends heavily upon remotely operated vehicles (ROVs). These are unoccupied robots usually linked to a surface ship by a group of cables. Most ROVs are equipped with one or more video cameras and lights, and may also carry other equipment such as a manipulator or cutting

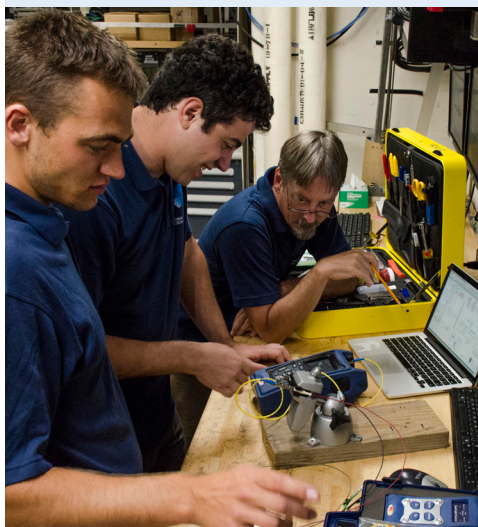

Electrical engineers picking up on some of the finer points of fiber optic measurements. Image courtesy of NOAA OER, 2017 Laulima O Ka Moana. <http://oceanexplorer.noaa.gov/oceanos/explorations/ex1706/logs/july15/media/fiber-optics.html>

arm, water samplers, equipment for collecting samples, and measuring instruments to expand the vehicle's capabilities for gathering data about the deep-ocean environment. For additional information about ROVs, please see the *Introduction to Remotely Operated Vehicles and Autonomous Underwater Vehicles* <http://oceanexplorer.noaa.gov/oceanos/edu/collection/media/hdwe-URintro.pdf>. For additional information about the exploration strategy, please see the *Introduction to Ships and Exploration Strategy* <http://oceanexplorer.noaa.gov/oceanos/edu/collection/media/hdwe-StrategyBkgnd.pdf>.

This lesson introduces students to the process used to design remotely operated vehicles.

Learning Procedure

1. To prepare for this lesson:

a) Review:

- Introductory essay about ROV *Deep Discoverer* <http://oceanexplorer.noaa.gov/technology/subs/deep-discoverer/deep-discoverer.html>;
- Daily log entries and video from the 2016 Deepwater Exploration of the Marianas Expedition <http://oceanexplorer.noaa.gov/oceanos/explorations/ex1605/dailyupdates/dailyupdates.html>

You may want to assign one or more of these as background reading prior to beginning the rest of the lesson.

b) Review background information about ocean exploration strategy and technologies.

c) Review the *Student Worksheet*. Two options are provided: Option A leaves the design and construction entirely to the students, while Option B provides step-by-step instructions for assembling a working model that meets the design requirement. Decide which approach is most appropriate for your students and learning objectives, and delete the option that will not be used. Copy the *Student Worksheet*, one copy for each student group.

d) Download images referenced in Step 2. You may also want

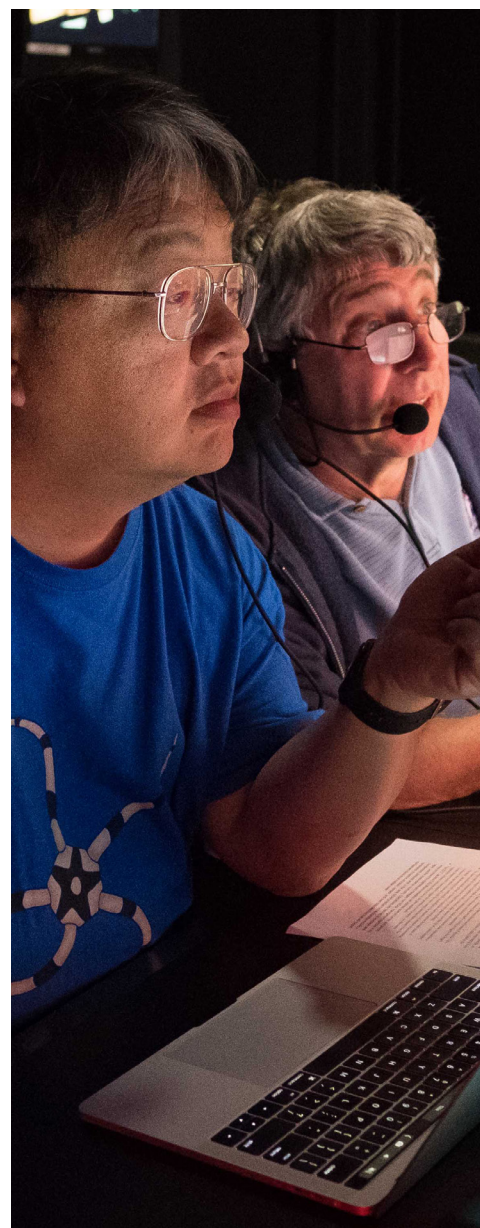
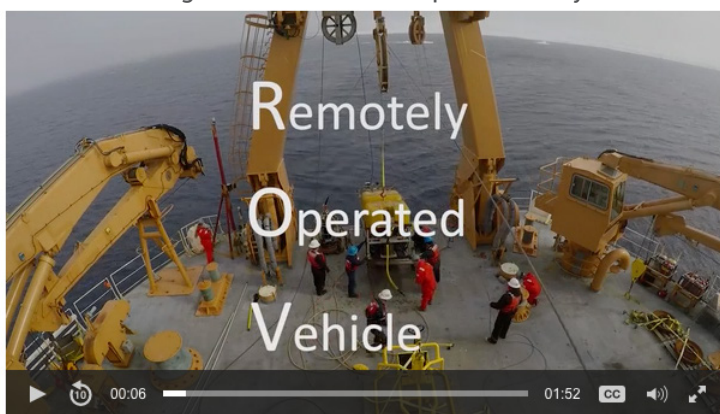

Invent a Robot!

Onboard science leads discuss and take a closer look at deepwater habitats explored with remotely operated vehicle *Deep Discoverer* on Horizon Guyot. Image courtesy of NOAA OER, 2017 Laulima O Ka Moana. <http://oceanexplorer.noaa.gov/oceanos/explorations/ex1706/dailyupdates/media/july13-1.html>

Learn more about the ROV's role in Arctic research in this video from The Hidden Ocean 2016: Chukchi Borderlands expedition. Video courtesy of Caitlin Bailey, GFOE, The Hidden Ocean 2016: Chukchi Borderlands, Oceaneering-DSSI. http://oceanexplorer.noaa.gov/explorations/16arctic/logs/video/interview/interview_video.html

Exploring the Deep Ocean with NOAA



Water samples are collected from the Niskin bottles on the CTD. All 20 Niskin bottles take water samples from various depths, starting near the seafloor and ending close to the surface. Photo courtesy of Caitlin Bailey, GFOE, *The Hidden Ocean 2016: Chukchi Borderlands*.

<http://oceanexplorer.noaa.gov/explorations/16arctic/logs/july24/media/shipton.html>

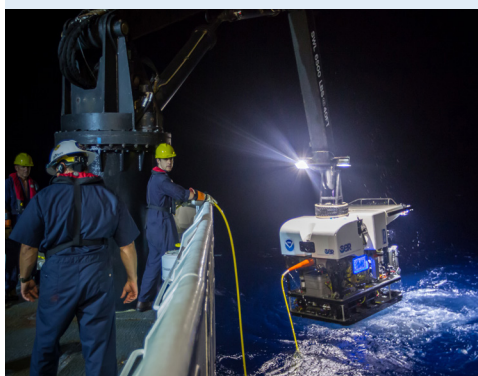

Remotely operated vehicle *Deep Discoverer* being recovered after a dive. Image courtesy of NOAA OER, 2016 Deepwater Exploration of the Marianas.

<http://oceanexplorer.noaa.gov/oceanos/explorations/ex1605/logs/may1/media/1605rovrecovery.html>



A Video Engineer adjusts the zoom, focus, and lighting on remotely operated vehicle *Deep Discoverer's* main HD camera to obtain the best shot of a tiny jellyfish. Image courtesy of NOAA OER, 2017 *Laulima O Ka Moana*.

<http://oceanexplorer.noaa.gov/oceanos/explorations/ex1706/dailyupdates/media/july27-2.html>



The NOAA Ship *Okeanos Explorer*, America's ship for ocean exploration. Image courtesy NOAA. <http://oceanexplorer.noaa.gov/oceanos/explorations/ex1702/logs/mar1/media/oceanos.html>

to download examples of imagery from underwater robots: http://oceanexplorer.noaa.gov/oceanos/media/slideshow/flash_slideshow.html and http://oceanexplorer.noaa.gov/oceanos/media/slideshow/video_playlist.html; and the following video about ROV design: <http://oceanexplorer.noaa.gov/oceanos/explorations/ex1302/edu.html>

2. Briefly introduce the ships of exploration NOAA Ship *Okeanos Explorer*, E/V *Nautilus*, and R/V *Falkor*; the *Introduction to Ships of Exploration and Their Strategy for Ocean Exploration* <http://oceanexplorer.noaa.gov/oceanos/edu/collection/media/hdwe-StrategyBkgnd.pdf>, and the 2017 *Discovering the Deep: Exploring Remote Pacific MPAs Expedition* <http://oceanexplorer.noaa.gov/oceanos/explorations/ex1703/background/plan/welcome.html>.

Briefly discuss why this kind of exploration is important (for background information, please see the lesson *To Boldly Go...* http://oceanexplorer.noaa.gov/oceanos/edu/collection/media/wdwe_toboldlygo.pdf.) Highlight the overall exploration strategy used by ships of exploration, including the following points:

- The overall strategy is to develop baseline information about the biological, geological, and water chemistry features of unexplored areas to provide a foundation for future exploration and research.
- This information includes:
 - High resolution maps of the area being explored, as well as areas that the ship crosses while underway from one location to the next (underway reconnaissance);
 - Exploration of water column chemistry and other features; and
 - High definition close-up video of biological and geological features in the exploration area (site characterization).

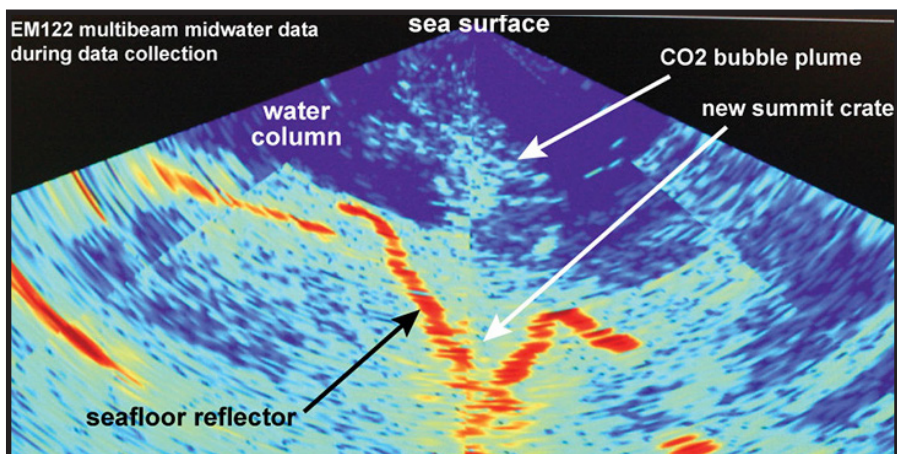

Image of the seafloor and midwater data during collection. The new crater at the summit is depicted by the red seafloor reflector. The CO₂ bubble plume rising from the crater is revealed by the light blue reflectors rising above the crater. Image courtesy of NOAA OER/NSF, Submarine Ring of Fire 2014 - Ironman. <http://oceanexplorer.noaa.gov/explorations/14fire/logs/december04/media/multibeam.html>

- This strategy relies on four key technologies:
 - Multibeam sonar mapping system and other types of sonar that can detect specific features in the water column and on the seafloor;
 - Conductivity, Temperature, and Depth profilers (CTDs) and other electronic sensors to measure chemical and physical seawater properties;
 - A Remotely Operated Vehicle (ROV) capable of obtaining high-quality imagery and samples in depths as great as 6,000 meters; and
 - Telepresence technologies that allow scientists with many different areas of expertise to observe and interact with exploration activities, though they may be thousands of miles from the ship.

You may want to show some or all of the images in the sidebars to accompany this review.

3. Explain that building complicated ROV systems such as *Deep Discoverer* involves a process called Engineering Design. If students are not already familiar with this concept, explain that Engineering Design is a process that engineers use to create solutions to problems. There are many versions of the process, but the basic steps are:

- Define the problem;
- Gather relevant information;
- Brainstorm possible solutions;
- Analyze possible solutions and select the most promising;
- Test the solution;
- Report results;
- Repeat to refine the design solution.

Defining the problem includes identifying constraints such as available materials and resources. Emphasize that research on a problem should be carried out before beginning to design a solution. This may involve Internet searches, market research, field observations, or consulting with others who have

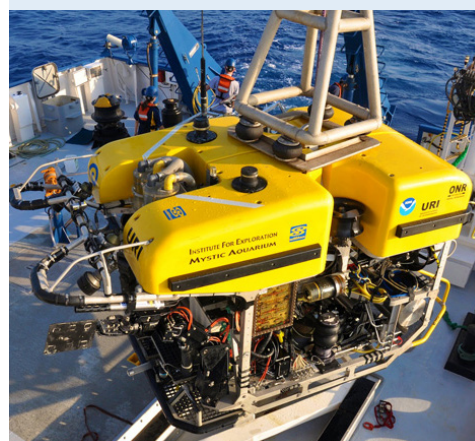

Hercules is one of the very few Remotely Operated Vehicles (ROV) specifically designed to be used as a scientific tool. Built for the Institute For Exploration (IFE), *Hercules* is equipped with special features that allow it to perform intricate tasks while descending to depths of 4,000 meters (2.5 miles). <http://oceanexplorer.noaa.gov/technology/subs/hercules/hercules.html>



Scientist Scott France participates in the dives from his home office via telepresence. Image courtesy of NOAA OER, 2016 Deepwater Exploration of the Marianas. <http://oceanexplorer.noaa.gov/oceanos/explorations/ex1605/logs/jun28/media/1605scott-france.html>



Rock samples collected are used to better understand the age and geologic history of complex regions. Image courtesy of NOAA OER, Deep-Sea Symphony: Exploring the Musicians Seamounts. <http://oceanexplorer.noaa.gov/oceanos/explorations/ex1708/dailyupdates/media/sept13-1.html>



Lava sampled to help shed light about this very rapidly erupting volcanic feature on Wagner Seamount. Image courtesy of NOAA OER, Deep-Sea Symphony: Exploring the Musicians Seamounts. <http://oceanexplorer.noaa.gov/oceanos/explorations/ex1708/logs/sept16/media/sampling.html>

experience with the defined problem. Often, a productive way to generate ideas is for people to work together to brainstorm, test, and refine possible solutions. Different proposals for solutions can be compared on the basis of how well each one meets the specified criteria for success and how well each takes the constraints into account.

Testing the solution often involves building models of simplified designs to be sure an idea will work before investing a lot of time and money to construct something more elaborate. This step is sometimes called prototyping or “proof of concept.” If the prototype works, the designers will continue to develop their solution with the same materials and techniques. If the prototype does not work, then designers must go back to a previous step and consider solutions that use other materials and techniques. This entire process may be repeated several times to improve the solution until results are satisfactory. For complex projects, these steps may be done by teams that work on different parts of the problem. An ROV such as *Deep Discoverer* might have a design team working on the video system, another team working on propulsion, and another responsible for electronics.

You may also want to point out that explorers often encounter unexpected problems or challenges during an expedition. A famous example is the Apollo 13 mission during which engineers on Earth had to design a “scrubber” that would remove carbon dioxide from the air that the astronauts had to breathe, using only materials that were already aboard the spacecraft. To find solutions for these kinds of challenges, explorers often turn to Engineering Design.

Remind students that *Deep Discoverer* is designed to obtain high quality video images in ocean environments as deep as 6,000 meters. It can also carry electronic instruments to measure environmental features such as temperature, and has a specialized robotic arm to provide a limited sample collection capability. Tell students that their task is to use the methods of Engineering Design to develop a robotic arm that is able to pick up objects that are about the size of a soda can.

Say that other teams working on this problem have decided that a hydraulic control system may be part of the solution to the robotic arm design task. So to begin their design process, students need to review some basic concepts of hydraulics and simple mechanics.

4. Be sure students are familiar with the following concepts related to simple machines:

- The exact number of “simple machines” depends to some extent upon your perspective, but the list typically includes levers, pulleys, wheel-and-axles, inclined planes, wedges, and screws. In some ways, through pulleys and wheel-and-axles



Remotely operated vehicle *Deep Discoverer's* manipulator arm, labeled. Image courtesy of Art Howard, GFOE; edited by Jeffery Laning, GFOE. <http://oceanexplorer.noaa.gov/oceanos/explorations/ex1702/logs/feb28/media/d2arm.html>

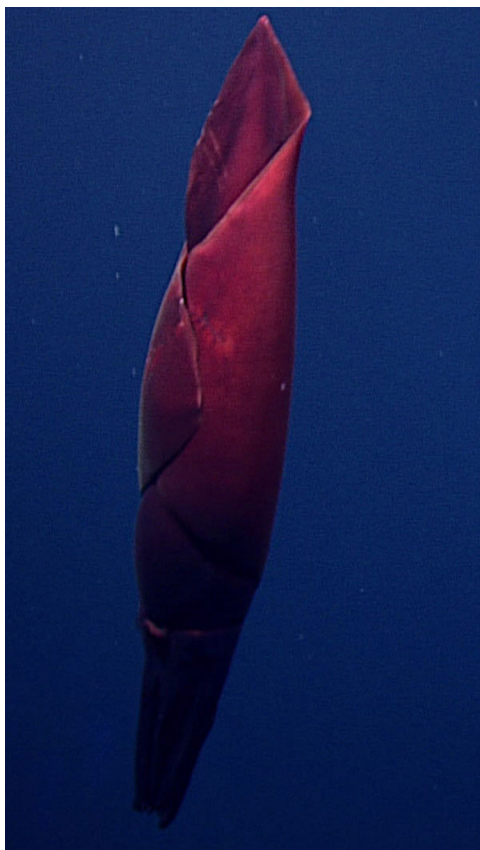

This gorgeous squid, probably *Taningia danae*, was seen as *Deep Discoverer* was descending to the seafloor. Image courtesy of NOAA OER. <http://oceanexplorer.noaa.gov/oceanos/explorations/ex1605/logs/jul8/media/1605squid.html>

are variations of the lever; and the wedge and screw are alternative forms of the inclined plane.

- Levers are divided into three classes, depending upon the positions of the input lever arm, the fulcrum, and the output arm (or load). In a Class I lever the fulcrum is between the input arm and the output arm (such as a crowbar). In a Class II lever, the output force is between the input force and the fulcrum (as in a wheelbarrow). In a Class III lever, the input force is between the output force and the fulcrum (as in a human arm).
- Mechanical advantage is the ratio of force output to force input. One of the big advantages of many simple machines is that they have high mechanical advantages, such as a crowbar, that essentially multiplies the force applied by a human by a factor of 2, 3, or more. But in some machines the mechanical advantage is less than 1, because the machine's purpose is not to increase the input force but rather to change the direction or distance over which the force operates.

5. Provide each student group with a copy of the *Student Worksheet*, and the materials listed in Part B of the *Worksheet*. Have each group complete Parts A and B of the *Worksheet*. Then lead a discussion of students' results. Students should understand that:

- Hydraulic refers to the use of confined liquid to transmit power, multiply force, or produce motion;
- Hydraulic systems use a liquid while pneumatic systems use air or other gases;
- An actuator is a mechanical device that converts energy into some kind of motion; and
- The energy that operates the actuators they built in Part B is mechanical energy from their own muscles that is transferred to the moving arm by the hydraulic system of the actuator.

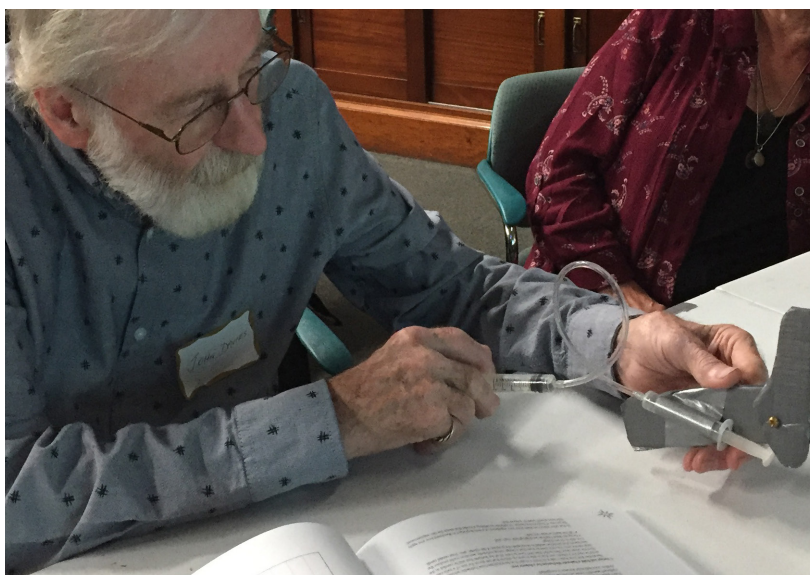

A robot arm completed in a Professional Development Workshop. Image courtesy NOAA OER.

Provide additional materials listed in Part C of the *Worksheet*, and any additional instructions or advice that may be needed. Encourage students to consider several possible solutions, and point out that optimization of designs involves testing different solutions to determine which of them best solves the problem, given the criteria and the constraints. You may want to require each group to present the concept for their model before they actually begin construction; if this is a requirement, you may want to provide the additional materials after the concept has been approved.

6. When students have completed Part C of the *Worksheet*, have each group present their model and explain its operation to the rest of the class. Ask students to describe the criteria and constraints that influenced their design, how they developed their solutions, and how they optimized their chosen solution. There are many ways to construct a model that meets the design requirements. The essential points are:
- Design requirements are clearly identified. For instance, the model must be able to grasp an object, such as an empty plastic cup, and lift the object at least one inch.
 - Several options are considered.
 - The selected option fulfills the design requirements.
 - If the model does not fulfill the design requirements, students should identify necessary modifications.

When all groups have presented their results, lead a class discussion about the next steps in designing a robotic arm that would be able to retrieve objects from the ocean floor, and what additional design decisions would be needed. The list of decisions includes:

- Materials for constructing the arm, considering environmental conditions in the deep ocean;
- Number of movements needed (this is called “degrees of freedom;” the actuator in Part B of the *Worksheet* has one degree of freedom; the human arm has more than 26 degrees of freedom);
- How the arm will be powered (are hydraulics the best solution; what are some other options);
- How the arm will be controlled from the surface; and
- What other sensors might be needed (such as a video camera mounted on the arm to show what is being lifted, or a pressure sensor on the gripper to know how much an object is being squeezed).

Be sure students realize that in a real hydraulic system, their hand muscles would be replaced by a pump to move hydraulic fluid in and out of actuators.



An unusual umbrella-shaped pedestal covered with corals and sponges. Zooming in revealed numerous shrimp, crabs, brittle stars, and fish living within this structure. Image courtesy of NOAA OER, Mountains in the Deep: Exploring the Central Pacific Basin.

<http://oceanexplorer.noaa.gov/oceanos/explorations/ex1705/dailyupdates/media/may5-1.html>



A crinoid observed during a dive as ROV *Deep Discoverer* (D2) explored a ridge feature along the outer slopes of Maug, one of the volcanoes within the Islands Unit of the Marianas Trench Marine National Monument. In the deep sea, absent of D2's artificial lights, this organism would appear black or disappear completely as red is one of the first colors to disappear from the visual spectrum in the ocean. Image courtesy of NOAA OER, 2016 Deepwater Exploration of the Marianas.
<http://oceanexplorer.noaa.gov/oceanos/explorations/ex1605/logs/jul11/welcome.html>

7. (Optional) Some Math Connections – Have students calculate the volume of hydraulic fluid (water in this case) needed to fill the system in their design. This will involve measuring the length and diameter of the syringes and tubing, and calculating volume as

$$V = \pi \cdot r^2 \cdot L$$

where V is volume, r is the radius of the tubing or syringe, and L is its length.

You may also have students verify their calculations by measuring the volume of water contained in their system.

The BRIDGE Connection

www.vims.edu/bridge/ – Scroll over “Ocean Science Topics” in the menu on the left side of the page, then “Human Activities,” then “Technology” for links to resources about submersibles, ROVs, and other technologies used in underwater exploration.

The “Me” Connection

Have students write a brief essay describing how they might personally use the process of Engineering Design. Emphasize that they might use this process to solve a problem that is not directly related to engineering, such as writing an essay, planning a road trip, or dealing with homework.

Connections to Other Subjects

English/Language Arts, Life Science, Mathematics, Physics

Assessment

Student’s models and class discussions provide opportunities for assessment.

Extensions

1. Visit the *Okeanos Explorer* Web page <http://oceanexplorer.noaa.gov/oceanos/welcome.html> for reports, images, and other products from *Okeanos Explorer* cruises.
2. Visit <http://www.marinetech.org/rov-competition-2/> for a video from the most recent Marine Technology Society’s student ROV competition, and links to other sites about underwater robots.
3. Visit http://seaperch.org/online_training_videos for ideas about building ROVs.

Multimedia Discovery Missions

<http://www.oceanexplorer.noaa.gov/edu/learning/welcome.html>

Click on the links to Lessons 1, 5 and 6 for interactive multimedia presentations and Learning Activities on Plate Tectonics, Chemosynthesis and Hydrothermal Vent Life, and Deep-Sea Benthos.

Other Relevant Lessons from NOAA OER

Call to Arms

<http://oceanexplorer.noaa.gov/edu/guide/media/gomdse11calltoarms56.pdf>

Focus - Robotic analogues for human structures (Grades 5-6; Life Science/Physical Science)

Students describe the types of motion found in the human arm; design and construct a model of a mechanical arm that mimics some or all of the motion capabilities of the human arm; describe combinations of simple machines that are used in their mechanical arm models; define mechanical advantage, and discuss the importance of mechanical advantage in robotic arm designs; and describe four common robotic arm designs that mimic motion capabilities of the human arm.

The Robot Ranger

<http://oceanexplorer.noaa.gov/explorations/09lophelia/background/edu/media/09ranger.pdf>

Focus - Robotic Analogues for Human Structures (Vision, Distance Estimation) (Grades 5-6; Life Science/Physical Science)

Students describe how humans are able to estimate the distance to visible objects, and describe a robotic system with a similar capability.

The Multi-Talented Underwater Robot

https://oceanexplorer.noaa.gov/edu/lessonplans/CarolinaCanyons_SentryAUV_2016.pdf

Focus - Autonomous Underwater Vehicle (AUV) Sentry (Grades 9-12; Engineering Design)

Students understand how engineers approach complex real-world problems by breaking them down into smaller, more manageable problems.

Next Generation Science Standards and Ocean Literacy Essential Principles and Fundamental Concepts

This lesson supports the Ocean Literacy Essential Principles and Fundamental Concepts as indicated here <http://oceanexplorer.noaa.gov/oceanos/edu/collection/media/hdwe-Standards.pdf>. Additionally, while it is not intended to target specific Next Generation Science Standards, activities in this lesson may be used to address the Performance Expectation as described below.

Specific NGSS Performance Expectation relevant to this lesson:

MS-ETS1-2. Evaluate competing design solutions using a systematic process to determine how well they meet the criteria and constraints of the problem.



The Next Generation Science Standards

The Next Generation Science Standards integrate three dimensions within each standard: Science and Engineering Practices, Disciplinary Core Ideas, and Crosscutting Concepts. The standards are written as student performance expectations. While specific performance expectations may emphasize only a few of the practice categories, teachers are encouraged to utilize several practices in any instruction. Similarly, only a few crosscutting concepts may be emphasized, but this is not intended to limit instruction.

For Information and Feedback

We value your feedback on this lesson, including how you use it in your formal/informal education settings. Please send your comments to: oceanexeducation@noaa.gov

Acknowledgments

Produced by Mel Goodwin, PhD, Marine Biologist and Science Writer, Charleston, SC. Design/layout: Coastal Images Graphic Design, Charleston, SC. If reproducing this lesson, please cite NOAA as the source, and provide the following URL: <http://oceanexplorer.noaa.gov>

Student Worksheet

Design Requirement

Your group is one of several teams working to design a robotic arm that is able to pick up objects that are about the size of a soda can from the ocean floor. One of the other design teams has suggested that hydraulic actuators may be part of the final design. Your team's task is to build a model that demonstrates how this could be done.

A. Review of Background Information

1. What does "hydraulic" mean?
2. What is the difference between "hydraulic" and "pneumatic?"
3. What is an actuator?

B. Build a Simple Hydraulic Actuator

Materials

- One piece of cardboard or heavy poster board, approximately 12" x 12" (the stiffer the better)
- Duct tape, approximately 2" x 60"
- Machine screw with nut, #8 x 1"
- 3 - Flat washers, #8 hole
- 2 - Oral syringes
- Plastic tubing, approximately 3/16" inside diameter x 12" (should fit snugly over the end of the syringes)
- Water
- Small container, such as a 9-oz drinking cup

Tools

- Heavy scissors to cut cardboard ("bandage scissors" are inexpensive and work well)
- Nail or Phillips screwdriver to punch holes in cardboard
- Screwdriver to fit machine screw
- Tape measure

Procedure

Option A

Your group has access to the tools and materials listed above. Use these resources to complete the Design Requirement.

Option B

- Build a Simple Hydraulic Actuator
 1. Cut two pieces of cardboard using the pattern on page 13 (Figure 1).

Figure 1.

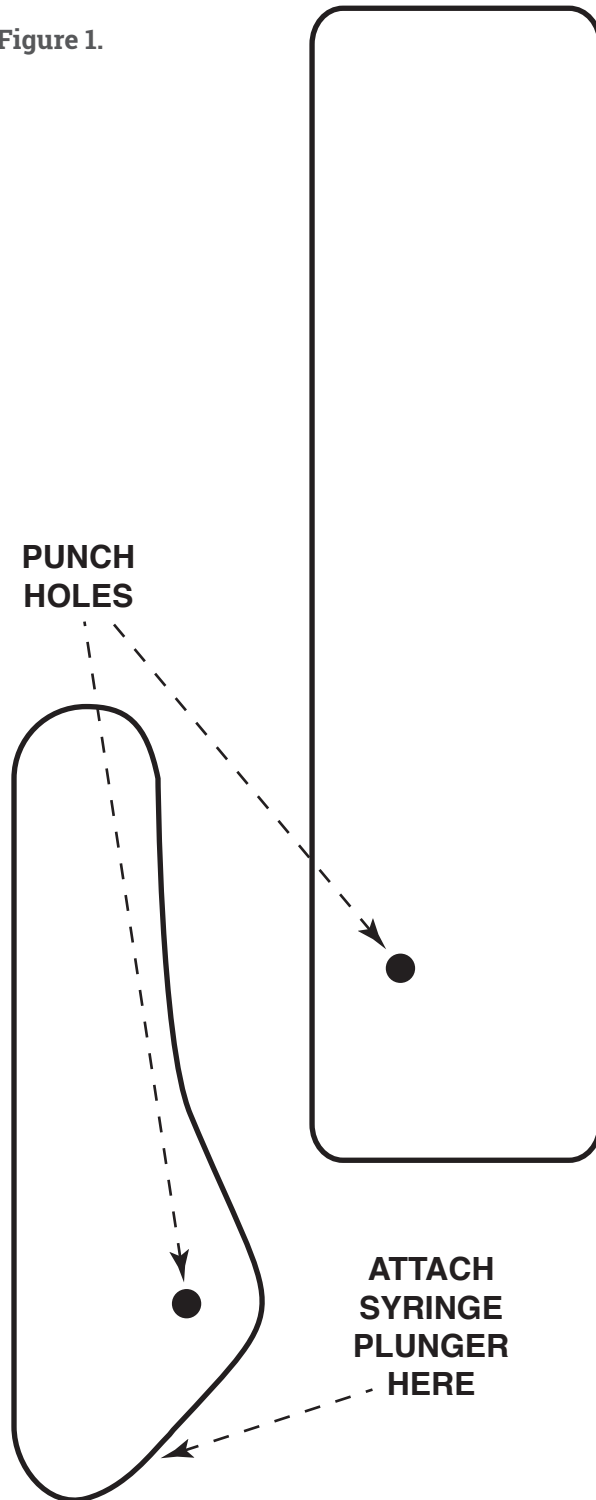

2. Reinforce the cardboard pieces: Put a piece of duct tape on one side, then cut off the excess tape around the edges. Put a second piece of duct tape on the other side, and trim the edges. Repeat this process, if necessary, until the pieces are very stiff.

3. Punch a hole in each of the pieces as shown on the pattern. The hole should be large enough for the #8 machine screw, but not much larger.

4. Attach the two pieces with a #8 machine screw, three flat washers, and a #8 nut as shown in Figure 2. You may need a screwdriver to twist the machine screw through the holes. Do not tighten the machine screw assembly too much; the pieces need to be able to move freely around the machine screw. You may find that an extra washer or nut between the two cardboard pieces allows for more motion.

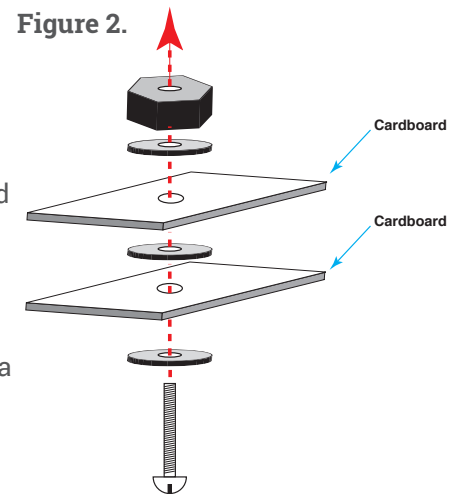

5. Take a piece of duct tape 6" long, and tear it in half lengthwise, and then tear one of these pieces in half lengthwise again. These narrower pieces of duct tape will be useful for attaching a syringe to the shorter piece of cardboard.

6. Attach the plunger of one syringe to the shorter piece of cardboard as indicated on the pattern. Tear one of the narrower pieces of duct tape in half, and wrap it around the plunger and cardboard as shown in Figure 3. Now wrap a second narrow piece of duct tape around the plunger at right angles to the first piece of tape. Add more tape if necessary, but you do not want the joint between the plunger and cardboard to be too tight.

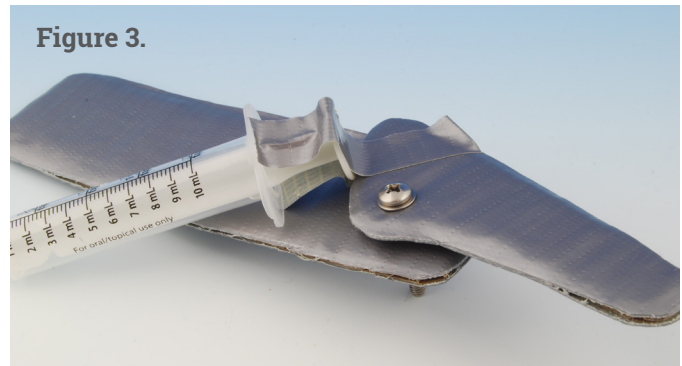

7. Tape the syringe onto the larger piece of cardboard as shown in Figure 4. Be sure the plunger is fully inserted into the barrel of the syringe.



8. Press one end of the plastic tubing onto the end of the other syringe so it is firmly attached. Place the other end of the plastic tubing into a small container of water, and pull the plunger back so that water is drawn into the tubing and syringe. Fill the syringe as full as possible, then hold the end of the plastic tubing so that it is higher than the end of the syringe, and slowly push on the plunger until the syringe is about half-full, and there is no air

in the syringe or plastic tubing. You may have to refill the syringe with more water and repeat this procedure a few times to get rid of all the air.

9. Attach the open end of the plastic tubing to the syringe that is taped to the cardboard assembly. Slowly press the plunger on the unattached syringe, and you should see the small arm on the cardboard assembly rotate around the machine screw. Pull out slowly on the plunger to reverse this motion. Your hydraulic actuator is completed!

C. Design and Build a Hydraulic Mechanism for a Robotic Arm

Remember that your team's task is to build a model that demonstrates how hydraulic actuators could be used for a robotic arm that is able to pick up objects that are about the size of a soda can from the ocean floor. This model does NOT have to have all of the features that will be needed in the final robotic arm. You only need to show that a design using hydraulic actuators could produce the movements that would be needed to accomplish the purpose of the robotic arm. Your model needs to be able to do two things:

- Grasp an object (such as an empty plastic cup); and
- Lift the object at least one inch.

So that other teams can learn from your experience, it is very important to document how you apply the process of Engineering Design. In addition to creating a model that meets the two requirements, your team should produce a report that:

1. Defines the problem;
2. Describes your solution, including a drawing of your model;
3. Explains your construction procedure; and
4. Reports the results of your tests of the model.

If your model cannot meet the design requirements, describe the modifications that you think are necessary to make it work.

Additional Materials

- Four pieces of cardboard or heavy poster board, each approximately 12" x 12"
- Duct tape, approximately 2" x 20'
- 9 - Machine screws with nuts, #8 x 1"
- 4 - Machine screws with nuts, #8 x 3"
- 17 - Flat washers, #8 hole

- 2 - Oral syringes
- Plastic tubing, approximately 3/16" inside diameter x 12"

Note: These materials are sufficient to construct many models that will meet the design requirements, but your model may not need all of them.

Tip: Cardboard arms and supports are much stronger if they are folded and taped to form beams with square or triangular cross-sections (see Figure 5).

Figure 5.

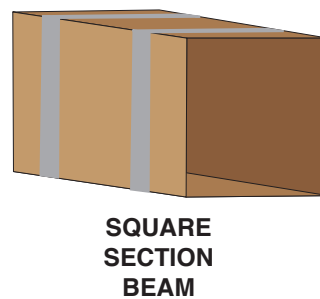
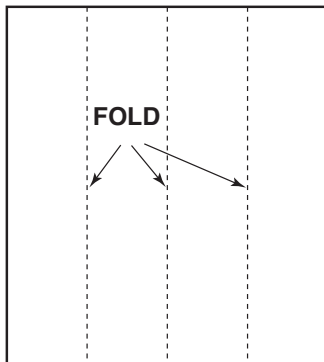
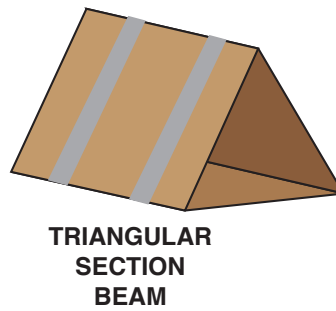
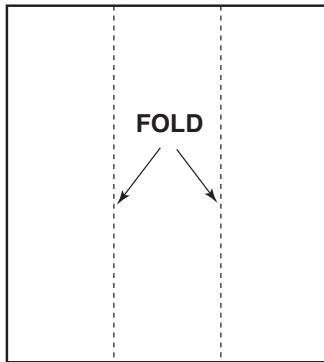



Ocean Literacy Essential Principles and Fundamental Concepts

Version 2: March 2013

	To Boldly Go (6-8)	What's the Big Deal (9-12)	Wet Maps (6-8)	Watching in 3D (9-12)	The Oceanographic Yo-yo (6-8)	Invent a Robot! (6-8)
EP 1. The Earth has one big ocean with many features.						
FC a. The ocean is the defining physical feature on our planet Earth—covering approximately 70% of the planet's surface. There is one ocean with many ocean basins, such as the North Pacific, South Pacific, North Atlantic, South Atlantic, Indian, Southern, and Arctic.	•					
FC b. Ocean basins are composed of the seafloor and all of its geological features (such as islands, trenches, mid-ocean ridges, and rift valleys) and vary in size, shape and features due to the movement of Earth's crust (lithosphere). Earth's highest peaks, deepest valleys and flattest plains are all in the ocean.			•	•	•	•
FC c. Throughout the ocean there is one interconnected circulation system powered by wind, tides, the force of Earth's rotation (Coriolis effect), the Sun and water density differences. The shape of ocean basins and adjacent land masses influence the path of circulation. This "global ocean conveyor belt" moves water throughout all of the ocean basins, transporting energy (heat), matter, and organisms around the ocean. Changes in ocean circulation have a large impact on the climate and cause changes in ecosystems.	•					
FC d. Sea level is the average height of the ocean relative to the land, taking into account the differences caused by tides. Sea level changes as plate tectonics cause the volume of ocean basins and the height of the land to change. It changes as ice caps on land melt or grow. It also changes as sea water expands and contracts when ocean water warms and cools.						
FC e. Most of Earth's water (97%) is in the ocean. Seawater has unique properties. It is salty, its freezing point is slightly lower than fresh water, its density is slightly higher, its electrical conductivity is much higher, and it is slightly basic. Balance of pH is vital for the health of marine ecosystems, and important in controlling the rate at which the ocean will absorb and buffer changes in atmospheric carbon dioxide.	•					
FC f. The ocean is an integral part of the water cycle and is connected to all of Earth's water reservoirs via evaporation and precipitation processes.						
FC g. The ocean is connected to major lakes, watersheds, and waterways because all major watersheds on Earth drain to the ocean. Rivers and streams transport nutrients, salts, sediments, and pollutants from watersheds to coastal estuaries and to the ocean.						
FC h. Although the ocean is large, it is finite, and resources are limited.	•	•				
EP 2. The ocean and life in the ocean shape the features of the Earth.						
FC a. Many earth materials and biogeochemical cycles originate in the ocean. Many of the sedimentary rocks now exposed on land were formed in the ocean. Ocean life laid down the vast volume of siliceous and carbonate rocks.						
FC b. Sea level changes over time have expanded and contracted continental shelves, created and destroyed inland seas, and shaped the surface of land.						
FC c. Erosion—the wearing away of rock, soil and other biotic and abiotic earth materials—occurs in coastal areas as wind, waves, and currents in rivers and the ocean, and the processes associated with plate tectonics move sediments. Most beach sand (tiny bits of animals, plants, rocks, and minerals) is eroded from land sources and carried to the coast by rivers; sand is also eroded from coastal sources by surf. Sand is redistributed seasonally by waves and coastal currents.						
FC d. The ocean is the largest reservoir of rapidly cycling carbon on Earth. Many organisms use carbon dissolved in the ocean to form shells, other skeletal parts, and coral reefs.						
FC e. Tectonic activity, sea level changes, and the force of waves influence the physical structure and landforms of the coast.						

Ocean Literacy Essential Principles and Fundamental Concepts

Version 2: March 2013

	To Boldly Go (6-8)	What's the Big Deal (9-12)	Wet Maps (6-8)	Watching in 3D (9-12)	The Oceanographic Yo-yo (6-8)	Invent a Robot! (6-8)
EP 3. The ocean is a major influence on weather and climate.						
FC a. The interaction of oceanic and atmospheric processes controls weather and climate by dominating the Earth's energy, water, and carbon systems.	•	•				
FC b. The ocean moderates global weather and climate by absorbing most of the solar radiation reaching Earth. Heat exchange between the ocean and atmosphere drives the water cycle and oceanic and atmospheric circulation.	•		•			
FC c. Heat exchange between the ocean and atmosphere can result in dramatic global and regional weather phenomena, impacting patterns of rain and drought. Significant examples include the El Niño Southern Oscillation and La Niña, which cause important changes in global weather patterns because they alter the sea surface temperature patterns in the Pacific.						
FC d. Condensation of water that evaporated from warm seas provides the energy for hurricanes and cyclones. Most rain that falls on land originally evaporated from the tropical ocean.						
FC e. The ocean dominates Earth's carbon cycle. Half of the primary productivity on Earth takes place in the sunlit layers of the ocean. The ocean absorbs roughly half of all carbon dioxide and methane that are added to the atmosphere.	•	•				
FC f. The ocean has had, and will continue to have, a significant influence on climate change by absorbing, storing, and moving heat, carbon, and water. Changes in the ocean's circulation have produced large, abrupt changes in climate during the last 50,000 years.	•	•				
FC g. Changes in the ocean-atmosphere system can result in changes to the climate that in turn, cause further changes to the ocean and atmosphere. These interactions have dramatic physical, chemical, biological, economic, and social consequences.	•	•				
EP 4. The ocean made Earth habitable.						
FC a. Most of the oxygen in the atmosphere originally came from the activities of photosynthetic organisms in the ocean. This accumulation of oxygen in Earth's atmosphere was necessary for life to develop and be sustained on land.						
FC b. The ocean is the cradle of life; the earliest evidence of life is found in the ocean. The millions of different species of organisms on Earth today are related by descent from common ancestors that evolved in the ocean and continue to evolve today.						
FC c. The ocean provided and continues to provide water, oxygen, and nutrients, and moderates the climate needed for life to exist on Earth (Essential Principles 1, 3, and 5).						
EP 5. The ocean supports a great diversity of life and ecosystems.						
FC a. Ocean life ranges in size from the smallest living things, microbes, to the largest animal on Earth, blue whales.						
FC b. Most of the organisms and biomass in the ocean are microbes, which are the basis of all ocean food webs. Microbes are the most important primary producers in the ocean. They have extremely fast growth rates and life cycles, and produce a huge amount of the carbon and oxygen on Earth.						
FC c. Most of the major groups that exist on Earth are found exclusively in the ocean and the diversity of major groups of organisms is much greater in the ocean than on land.						
FC d. Ocean biology provides many unique examples of life cycles, adaptations, and important relationships among organisms (symbiosis, predator-prey dynamics, and energy transfer) that do not occur on land.						
FC e. The ocean provides a vast living space with diverse and unique ecosystems from the surface through the water column and down to, and below, the seafloor. Most of the living space on Earth is in the ocean.			•	•	•	•

Ocean Literacy Essential Principles and Fundamental Concepts

Version 2: March 2013

	To Boldly Go (6-8)	What's the Big Deal (9-12)	Wet Maps (6-8)	Watching in 3D (9-12)	The Oceanographic Yo-yo (6-8)	Invent a Robot! (6-8)
EP 5. The ocean supports a great diversity of life and ecosystems. (continued)						
FC f. Ocean ecosystems are defined by environmental factors and the community of organisms living there. Ocean life is not evenly distributed through time or space due to differences in abiotic factors such as oxygen, salinity, temperature, pH, light, nutrients, pressure, substrate, and circulation. A few regions of the ocean support the most abundant life on Earth, while most of the ocean does not support much life.						
FC g. There are deep ocean ecosystems that are independent of energy from sunlight and photosynthetic organisms. Hydrothermal vents, submarine hot springs, and methane cold seeps, rely only on chemical energy and chemosynthetic organisms to support life.			•	•	•	•
FC h. Tides, waves, predation, substrate, and/or other factors cause vertical zonation patterns along the coast; density, pressure, and light levels cause vertical zonation patterns in the open ocean. Zonation patterns influence organisms' distribution and diversity.						
FC i. Estuaries provide important and productive nursery areas for many marine and aquatic species.						
EP 6. The ocean and humans are inextricably interconnected.						
FC a. The ocean affects every human life. It supplies freshwater (most rain comes from the ocean) and nearly all Earth's oxygen. The ocean moderates the Earth's climate, influences our weather, and affects human health.	•					
FC b. The ocean provides food, medicines, and mineral and energy resources. It supports jobs and national economies, serves as a highway for transportation of goods and people, and plays a role in national security.	•	•	•	•	•	•
FC c. The ocean is a source of inspiration, recreation, rejuvenation, and discovery. It is also an important element in the heritage of many cultures.						
FC d. Humans affect the ocean in a variety of ways. Laws, regulations, and resource management affect what is taken out and put into the ocean. Human development and activity leads to pollution (point source, nonpoint source, and noise pollution), changes to ocean chemistry (ocean acidification), and physical modifications (changes to beaches, shores, and rivers). In addition, humans have removed most of the large vertebrates from the ocean.	•					
FC e. Changes in ocean temperature and pH due to human activities can affect the survival of some organisms and impact biological diversity (coral bleaching due to increased temperature and inhibition of shell formation due to ocean acidification).	•					
FC f. Much of the world's population lives in coastal areas. Coastal regions are susceptible to natural hazards (tsunamis, hurricanes, cyclones, sea level change, and storm surges).						
FC g. Everyone is responsible for caring for the ocean. The ocean sustains life on Earth and humans must live in ways that sustain the ocean. Individual and collective actions are needed to effectively manage ocean resources for all.	•	•	•	•	•	•

Ocean Literacy Essential Principles and Fundamental Concepts

Version 2: March 2013

EP 7. The ocean is largely unexplored.	To Boldly Go (6-8)	What's the Big Deal (9-12)	Wet Maps (6-8)	Watching in 3D (9-12)	The Oceanographic Yo-yo (6-8)	Invent a Robot! (6-8)
FC a. The ocean is the largest unexplored place on Earth—less than 5% of it has been explored. The next generation of explorers and researchers will find great opportunities for discovery, innovation, and investigation.	•	•	•	•	•	•
FC b. Understanding the ocean is more than a matter of curiosity. Exploration, experimentation, and discovery are required to better understand ocean systems and processes. Our very survival hinges upon it.	•	•	•	•	•	•
FC c. Over the last 50 years, use of ocean resources has increased significantly; the future sustainability of ocean resources depends on our understanding of those resources and their potential.	•	•	•	•	•	•
FC d. New technologies, sensors, and tools are expanding our ability to explore the ocean. Scientists are relying more and more on satellites, drifters, buoys, subsea observatories, and unmanned submersibles.	•		•	•	•	•
FC e. Use of mathematical models is an essential part of understanding the ocean system. Models help us understand the complexity of the ocean and its interactions with Earth's interior, atmosphere, climate, and land masses.			•	•		
FC f. Ocean exploration is truly interdisciplinary. It requires close collaboration among biologists, chemists, climatologists, computer programmers, engineers, geologists, meteorologists, physicists, animators, and illustrators. And these interactions foster new ideas and new perspectives for inquiries.	•		•	•	•	•